



SANSERA ENGINEERING LIMITED

Our Company was incorporated as Sansera Engineering Private Limited on December 15, 1981 at Bengaluru, Karnataka, India as a private limited company under the Companies Act, 1956. Our Company was converted into a public limited company pursuant to a special resolution passed by our Shareholders at the EGM held on June 19, 2018 and the name of our Company was changed to Sansera Engineering Limited. A fresh certificate of incorporation consequent upon conversion to a public limited company was issued by the Registrar of Companies, Karnataka situated in Bangalore ("RoC") on June 29, 2018. For further details, see "History and Certain Corporate Matters" on page 188.

Registered Office and Corporate Office: Plant 7, Plot No. 143/A, Jigani Link Road, Bommasandra Industrial Area, Anekal Taluk, Bengaluru 560 105, Karnataka, India; **Tel:** +91 80 2783 9081/ 9082/ 9083
Website: www.sansera.in; **Contact Person:** Rajesh Kumar Modi, Company Secretary and Compliance Officer; **E-mail:** rajesh.modi@sansera.in
Corporate Identity Number: U34103KA1981PLC004542

OUR PROMOTERS: SUBRAMONIA SEKHAR VASAN, FATHERAJ SINGHVI, UNNI RAJAGOPAL KOTHENATH AND DEVAPPA DEVARAJ

INITIAL PUBLIC OFFER OF UP TO 17,244,328 EQUITY SHARES OF FACE VALUE OF ₹2 EACH ("EQUITY SHARES") OF SANSERA ENGINEERING LIMITED ("COMPANY" OR "ISSUER") FOR CASH AT A PRICE OF ₹[•] PER EQUITY SHARE ("OFFER PRICE"), THROUGH AN OFFER FOR SALE OF UP TO 17,244,328 EQUITY SHARES AGGREGATING UP TO ₹[•] MILLION ("OFFER") BY THE SELLING SHAREHOLDERS, COMPRISING OF UP TO 8,635,408 EQUITY SHARES BY CLIENT EBENE LIMITED ("CEL"), UP TO 4,836,723 EQUITY SHARES BY CVCIGP II EMPLOYEE EBENE LIMITED ("EEL") (COLLECTIVELY THE "INVESTOR SELLING SHAREHOLDERS"), UP TO 2,058,069 EQUITY SHARES BY SUBRAMONIA SEKHAR VASAN; UP TO 571,376 EQUITY SHARES BY UNNI RAJAGOPAL KOTHENATH; UP TO 571,376 EQUITY SHARES BY FATHERAJ SINGHVI* AND UP TO 571,376 EQUITY SHARES BY DEVAPPA DEVARAJ (COLLECTIVELY, THE "PROMOTER SELLING SHAREHOLDERS", AND TOGETHER WITH THE INVESTOR SELLING SHAREHOLDERS, THE "SELLING SHAREHOLDERS"). THIS OFFER INCLUDES A RESERVATION OF UP TO [•] EQUITY SHARES, AGGREGATING UP TO ₹ 90 MILLION (CONSTITUTING UP TO [•] % OF THE POST-OFFER PAID-UP EQUITY SHARE CAPITAL) FOR PURCHASE BY ELIGIBLE EMPLOYEES (THE "EMPLOYEE RESERVATION PORTION"). THE OFFER LESS THE EMPLOYEE RESERVATION PORTION IS HERINAFTER REFERRED TO AS THE "NET OFFER". THE OFFER AND THE NET OFFER WOULD CONSTITUTE AT LEAST [•] % AND [•] %, RESPECTIVELY, OF OUR POST-OFFER PAID-UP EQUITY SHARE CAPITAL. OUR COMPANY, IN CONSULTATION WITH THE BRLMS AND THE SELLING SHAREHOLDERS, MAY OFFER DISCOUNT OF UP TO [•] % (EQUIVALENT TO ₹[•] PER EQUITY SHARE) TO RETAIL INDIVIDUAL BIDDERS ("RETAIL DISCOUNT") AND DISCOUNT OF UP TO 5.00% (EQUIVALENT TO ₹[•] PER EQUITY SHARE) TO THE OFFER PRICE TO ELIGIBLE EMPLOYEES BIDDING IN THE EMPLOYEE RESERVATION PORTION ("EMPLOYEE DISCOUNT").

THE PRICE BAND WILL BE DECIDED BY OUR COMPANY WITH THE CONSENT OF THE INVESTOR SELLING SHAREHOLDERS IN CONSULTATION WITH THE BRLMS AND THE PROMOTER SELLING SHAREHOLDERS AND THE MINIMUM BID LOT, THE EMPLOYEE DISCOUNT AND RETAIL DISCOUNT, IF ANY, WILL BE DECIDED BY OUR COMPANY IN CONSULTATION WITH THE BRLMS AND SELLING SHAREHOLDERS AND WILL BE ADVERTISED IN ALL EDITIONS OF FINANCIAL EXPRESS, AN ENGLISH NATIONAL DAILY NEWSPAPER, DELHI EDITION OF JANSATTA, A HINDI NATIONAL DAILY NEWSPAPER AND BANGALORE EDITION OF VISHAVANI, A KANNADA DAILY NEWSPAPER (KANNADA BEING THE REGIONAL LANGUAGE OF KARNATAKA WHERE OUR REGISTERED OFFICE IS LOCATED) AT LEAST TWO WORKING DAYS PRIOR TO THE BID/ OFFER OPENING DATE AND SHALL BE MADE AVAILABLE TO BSE LIMITED ("BSE") AND NATIONAL STOCK EXCHANGE OF INDIA LIMITED ("NSE"), AND TOGETHER WITH BSE, THE "STOCK EXCHANGES") FOR THE PURPOSE OF UPLOADING ON ITS WEBSITE IN ACCORDANCE WITH THE SECURITIES AND EXCHANGE BOARD OF INDIA (ISSUE OF CAPITAL AND DISCLOSURE REQUIREMENTS) REGULATIONS, 2018, AS AMENDED (THE "SEBI ICDR REGULATIONS").

* Fatheraj Singhvi is acting in trust for the offer for sale of up to 61,221 Equity Shares by Lalitha Singhvi, up to 62,031 Equity Shares by Praveen Singhvi, up to 62,031 Equity Shares by Lata Singhvi, up to 62,031 Equity Shares by Jayaraj Singhvi, up to 62,031 Equity Shares by Tara Singhvi and up to 62,031 Equity Shares by Indira Singhvi (collectively, the "Singhvi Family Shareholders"). For details, see "The Offer" and "Capital Structure" on pages 54 and 68, respectively

In case of any revision in the Price Band, the Bid/ Offer Period will be extended by at least three additional Working Days after such revision in the Price Band, subject to the Bid/ Offer Period not exceeding 10 Working Days. In cases of force majeure, strike or similar circumstances, our Company may, for reasons to be recorded in writing, extend the Bid/ Offer Period for a minimum of three Working Days, subject to the Bid/ Offer Period not exceeding 10 Working Days. Any revision in the Price Band and the revised Bid/ Offer Period, if applicable, shall be widely disseminated by notification to the Stock Exchanges, by issuing a press release, and also by indicating the change on the respective websites of the BRLMs and at the terminals of the Syndicate and by intimation to Designated Intermediaries and the Sponsor Bank, as applicable.

The Offer is being made through the Book Building Process, in terms of Rule 19(2)(b) of the Securities Contracts (Regulation) Rules, 1957, as amended ("SCRR") read with Regulation 31 of the SEBI ICDR Regulations and in compliance with Regulation 6(1) of the SEBI ICDR Regulations wherein not more than 50% of the Net Offer shall be available for allocation on a proportionate basis to Qualified Institutional Buyers ("QIBs") (the "QIB Portion"), provided that our Company with the consent of the Investor Selling Shareholders in consultation with the BRLMs and Promoter Selling Shareholders may allocate up to 60% of the QIB Portion to Anchor Investors on a discretionary basis. In the event of under-subscription, or non-allocation in the Anchor Investor Portion, the balance Equity Shares shall be added to the QIB Portion. One-third of the Anchor Investor Portion shall be reserved for domestic Mutual Funds, subject to valid Bids being received from the domestic Mutual Funds at or above the Anchor Investor Allocation Price. 5% of the QIB Portion (excluding the Anchor Investor Portion) shall be available for allocation on a proportionate basis to Mutual Funds only, and the remainder of the QIB Portion shall be available for allocation on a proportionate basis to all QIB Bidders (other than Anchor Investors), including Mutual Funds, subject to valid Bids being received at or above the Offer Price. However, if the aggregate demand from Mutual Funds is less than 5% of the QIB Portion, the balance Equity Shares available for allocation in the Mutual Fund Portion will be added to the remaining QIB Portion for proportionate allocation to QIBs. Further, not less than 15% of the Net Offer shall be available for allocation on a proportionate basis to Non-Institutional Bidders and not less than 35% of the Net Offer shall be available for allocation to RIBs in accordance with the SEBI ICDR Regulations, subject to valid Bids being received from them at or above the Offer Price (net of Retail Discount, if any). Further, Equity Shares will be allocated on a proportionate basis to Eligible Employees applying under the Employee Reservation Portion, subject to valid Bids received from them at or above the Offer Price. All Bidders (except Anchor Investors) are required to mandatorily utilise the Application Supported by Blocked Amount ("ASBA") process providing details of their respective bank account (including UPI ID for RIBs using UPI Mechanism), in which the corresponding Bid Amounts will be blocked by the SCSBs or the Sponsor Bank, as applicable. Anchor Investors are not permitted to participate in the Offer through the ASBA process. For details, see "Offer Procedure" on page 344.

RISKS IN RELATION TO THE FIRST OFFER

This being the first public offer of our Company, there has been no formal market for the Equity Shares. The face value of the Equity Shares is ₹2. The Floor Price and Cap Price as determined and justified by our Company and the Investor Selling Shareholder in consultation with the BRLMs and the Promoter Selling Shareholders and the Offer Price as determined and justified by our Company in consultation with the BRLMs and the Selling Shareholders, in accordance with the SEBI ICDR Regulations, as stated under "Basis for Offer Price" on page 86 should not be taken to be indicative of the market price of the Equity Shares after the Equity Shares are listed. No assurance can be given regarding an active and/or sustained trading in the Equity Shares nor regarding the price at which the Equity Shares will be traded after listing.

GENERAL RISK

Investments in equity and equity-related securities involve a degree of risk and investors should not invest any funds in the Offer unless they can afford to take the risk of losing their entire investment. Investors are advised to read the risk factors carefully before taking an investment decision in the Offer. For taking an investment decision, investors must rely on their own examination of our Company and the Offer, including the risks involved. The Equity Shares in the Offer have not been recommended or approved by the Securities and Exchange Board of India ("SEBI"), nor does SEBI guarantee the accuracy or adequacy of the contents of this Red Herring Prospectus. Specific attention of the prospective investors is invited to "Risk Factors" on page 22.

ISSUER'S AND THE SELLING SHAREHOLDERS' ABSOLUTE RESPONSIBILITY

Our Company, having made all reasonable inquiries, accepts responsibility for and confirms that this Red Herring Prospectus contains all information with regard to our Company and the Offer, which is material in the context of the Offer, that the information contained in this Red Herring Prospectus is true and correct in all material aspects and is not misleading in any material respect, that opinions and intentions expressed herein are honestly held and that there are no other facts, the omission of which makes this Red Herring Prospectus as a whole or any of such information or the expression of any such opinions or intentions misleading in any material respect. Further, each Selling Shareholder severally and not jointly accepts responsibility for and confirms only statements made or undertaken expressly by such Selling Shareholder in this Red Herring Prospectus solely in relation to itself and the respective portion of the Offered Shares offered by such Selling Shareholder and assumes responsibility that such statements are true and correct in all material respects and not misleading in any material respect. Each of the Selling Shareholders, severally and not jointly, assumes no responsibility for any other statements, made by or relating to our Company or its business in this Red Herring Prospectus.

LISTING

The Equity Shares offered through this Red Herring Prospectus are proposed to be listed on the Stock Exchanges. Our Company has received 'in-principle' approval from BSE and NSE for the listing of the Equity Shares pursuant to letters dated June 28, 2021 and July 8, 2021, respectively. For the purposes of the Offer, the Designated Stock Exchange shall be BSE. A signed copy of this Red Herring Prospectus and the Prospectus shall be delivered for filing with the RoC in accordance with Section 26(4) of the Companies Act. For details of the material contracts and documents available for inspection from the date of this Red Herring Prospectus up to the Bid/ Offer Closing Date, see "Material Contracts and Documents for Inspection" on page 365.

BOOK RUNNING LEAD MANAGERS

REGISTRAR TO THE OFFER

<p>ICICI Securities Limited ICICI Centre, H. T. Parekh Marg Churchgate Mumbai 400 020 Maharashtra, India Tel: +91 22 2288 2460 E-mail: sansera ipo@icicisecurities.com Investor grievance customercare@icicisecurities.com Website: www.icicisecurities.com Contact Person: Shekher Asnani / Anurag Byas SEBI Registration No.: INM000011179</p>	<p>IIFL Securities Limited 10th Floor, IIFL Centre Kamala City, Senapati Bapat Marg Lower Parel (West) Mumbai 400 013 Maharashtra, India Tel: +91 22 4646 4600 E-mail: sansera.ipo@iiflcap.com Investor grievance e-mail: ig.ib@iiflcap.com Website: www.iiflcap.com Contact Person: Mukesh Garg/ Dhruv Bhagwat SEBI Registration No.: MB/INM000010940</p>	<p>Nomura Financial Advisory and Securities (India) Private Limited Ceejay House, Level 11 Plot F, Shivsagar Estate Dr. Annie Besant Road, Worli Mumbai 400 018, Maharashtra, India Tel: +91 22 4037 4037 E-mail: sanseraiipo@nomura.com Investor grievance e-mail: investorgrievances-in@nomura.com Website: www.nomuraholdings.com/company/group/asia/india/ind ex.html Contact Person: Vishal Kanjani / Kshitij Thakur SEBI Registration No.: INM000011419</p>	<p>Link Intime India Private Limited C-101, 1st Floor, 247 Park L.B.S. Marg, Vikhroli (West) Mumbai 400 083 Maharashtra, India Tel: 022 4918 6200 E-mail: sansera.ipo@linkintime.co.in Investor grievance e-mail: sansera.ipo@linkintime.co.in Website: www.linkintime.co.in Contact Person: Shanti Gopalkrishnan SEBI Registration No.: INR000004058</p>

BID/ OFFER SCHEDULE

BID/ OFFER OPENS ON	September 14, 2021 ⁽¹⁾	BID/ OFFER CLOSES ON	September 16, 2021 ⁽²⁾
----------------------------	-----------------------------------	-----------------------------	-----------------------------------

⁽¹⁾ Our Company with the consent of the Investor Selling Shareholders in consultation with the BRLMs and the Promoter Selling Shareholders, may consider participation by Anchor Investors in accordance with the SEBI ICDR Regulations. The Anchor Investor Bid/ Offer Period shall be one Working Day prior to the Bid/ Offer Opening Date.

⁽²⁾ Our Company with the consent of the Investor Selling Shareholders in consultation with the BRLMs and the Promoter Selling Shareholders, may consider closing the Bid/ Offer Period for QIBs one Working Day prior to the Bid/ Offer Closing Date in accordance with the SEBI ICDR Regulations.

[This page has been intentionally left blank]

TABLE OF CONTENTS

SECTION I: GENERAL	1
DEFINITIONS AND ABBREVIATIONS	1
OFFER DOCUMENT SUMMARY	14
CERTAIN CONVENTIONS, PRESENTATION OF FINANCIAL, INDUSTRY AND MARKET DATA AND CURRENCY OF PRESENTATION.....	18
FORWARD-LOOKING STATEMENTS.....	21
SECTION II: RISK FACTORS	22
SECTION III: INTRODUCTION	54
THE OFFER.....	54
SUMMARY OF FINANCIAL INFORMATION	56
GENERAL INFORMATION	61
CAPITAL STRUCTURE.....	68
OBJECTS OF THE OFFER.....	84
BASIS FOR OFFER PRICE	86
STATEMENT OF SPECIAL TAX BENEFITS	89
SECTION IV: ABOUT OUR COMPANY	94
INDUSTRY OVERVIEW.....	94
OUR BUSINESS.....	147
KEY REGULATIONS AND POLICIES.....	184
HISTORY AND CERTAIN CORPORATE MATTERS.....	188
OUR MANAGEMENT.....	197
OUR PROMOTERS AND PROMOTER GROUP.....	211
OUR GROUP COMPANIES	215
DIVIDEND POLICY	218
SECTION V: FINANCIAL INFORMATION	219
FINANCIAL STATEMENTS.....	219
OTHER FINANCIAL INFORMATION	280
CAPITALISATION STATEMENT.....	281
MANAGEMENT'S DISCUSSION AND ANALYSIS OF FINANCIAL CONDITION AND RESULTS OF OPERATIONS	282
FINANCIAL INDEBTEDNESS.....	313
SECTION VI: LEGAL AND OTHER INFORMATION	316
OUTSTANDING LITIGATION AND MATERIAL DEVELOPMENTS	316
GOVERNMENT AND OTHER APPROVALS	321
OTHER REGULATORY AND STATUTORY DISCLOSURES.....	324
SECTION VII: OFFER INFORMATION	336
TERMS OF THE OFFER	336
OFFER STRUCTURE	341
OFFER PROCEDURE.....	344
RESTRICTIONS ON FOREIGN OWNERSHIP OF INDIAN SECURITIES	358
SECTION VIII: DESCRIPTION OF EQUITY SHARES AND TERMS OF ARTICLES OF ASSOCIATION	360
SECTION IX: OTHER INFORMATION	365
MATERIAL CONTRACTS AND DOCUMENTS FOR INSPECTION.....	365
DECLARATION	367

SECTION I: GENERAL

DEFINITIONS AND ABBREVIATIONS

This Red Herring Prospectus uses certain definitions and abbreviations which, unless the context otherwise indicates or implies, shall have the meaning as provided below. References to any legislation, act, regulation, rules, guidelines or policies shall be to such legislation, act, regulation, rules, guidelines or policies as amended, supplemented or re-enacted from time to time, and any reference to a statutory provision shall include any subordinate legislation made from time to time under that provision.

The words and expressions used in this Red Herring Prospectus but not defined herein shall have, to the extent applicable, the same meaning ascribed to such terms under the SEBI ICDR Regulations, the Companies Act, the SCRA, the Depositories Act and the rules and regulations made thereunder. Notwithstanding the foregoing, the terms used in “Industry Overview”, “Key Regulations and Policies”, “Statement of Special Tax Benefits”, “Financial Statements”, “Basis for Offer Price”, “Outstanding Litigation and Material Developments” and “Description of Equity Shares and Terms of Articles of Association” on pages 94, 184, 89, 219, 86, 316 and 360 respectively shall have the meaning ascribed to them in the relevant section.

General Terms

Term	Description
“our Company”, “the Company”, “the Issuer” or “Sansera”	Sansera Engineering Limited, a company incorporated under the Companies Act, 1956 having its Registered Office and Corporate Office at Plant 7, Plot No. 143/A, Jigani Link Road, Bommasandra Industrial Area, Anekal Taluk, Bengaluru 560 105, Karnataka, India
“we”, “us” or “our”	Unless the context requires otherwise, refers to our Company and our Subsidiaries as applicable, as at and during the relevant period/ Financial Year

Company and Selling Shareholders Related Terms

Term	Description
“Articles of Association” or “AoA”	Articles of association of our Company, as amended
Audit Committee	Audit committee of our Company, constituted in accordance with the applicable provisions of the Companies Act, the Listing Regulations, and as described in “ <i>Our Management – Audit Committee</i> ” on page 202
“Auditors” or “Statutory Auditors”	Current statutory auditors of our Company, namely, Deloitte Haskins & Sells, Chartered Accountants
“Board” or “Board of Directors”	Board of directors of our Company, as constituted from time to time, including a duly constituted committee thereof
CCPS	Compulsorily convertible preference shares
CEO	Chief Executive Officer of our Company, being B R Preetham. For details, see “ <i>Our Management – Key Managerial Personnel</i> ” on page 208
CEL	Client Ebene Limited, a validly existing company incorporated under the laws of Mauritius having its registered office at Sanne House, Bank Street, TwentyEight, Cybercity, Ebene 72201 Mauritius
“CFO” or “Chief Financial Officer”	Chief Financial Officer of our Company, being Vikas Goel. For details, see “ <i>Our Management – Key Managerial Personnel</i> ” on page 208
Company Secretary and Compliance Officer	Company Secretary and Compliance Officer of our Company, being Rajesh Kumar Modi. For details, see “ <i>Our Management – Key Managerial Personnel</i> ” on page 208
Corporate Social Responsibility Committee	Corporate social responsibility committee of our Company constituted in accordance with the applicable provisions of the Companies Act and as described in “ <i>Our Management – Corporate Social Responsibility Committee</i> ” on page 205
“CRISIL” or “CRISIL Research”	CRISIL Limited
CRISIL Report	Report titled ‘ <i>Assessment of Indian Automotive and Precision Engineering Industry and Potential for Specific Forged and Machined Components</i> ’ issued on June 5, 2021 by CRISIL
Director(s)	The directors on our Board, as appointed from time to time
EEL	CVCIGP II Employee Ebene Limited, a validly existing company incorporated under the laws of Mauritius having its registered office at Sanne House, Bank Street, TwentyEight, Cybercity, Ebene 72201 Mauritius
Equity Shares	Equity shares of our Company having a face value of ₹2 each
Executive Director	An executive director of our Company
ESOP 2015	Sansera Engineering Limited Employee Stock Option Plan, 2015
ESOP 2018	Sansera Engineering Limited Employee Stock Option Plan, 2018
Fitwel	Fitwel Tools and Forgings Private Limited
Fitwel Plant 1	Manufacturing unit situated at (i) Unit No. 5; (ii) Unit No. 6, Press Line; (iii) C 11 and C12, Dire and Tools; (iv) C 13; (v) C 14, all at KHT Complex, Antharasanahalli, Bengaluru, Karnataka and Survey number 47/1 Antharasanahalli, Tumkur 572 106, Karnataka
Fitwel Plant 2	Manufacturing unit of Fitwel situated at Unit No. 11, KHT Complex, Antharasanahalli, 1st stage, Tumkur, Karnataka
Gearock Forge	Gearock Forge Private Limited
Group Companies	Our group companies, namely Client Ebene Limited and CVCIGP II Employee Ebene Limited as disclosed in “ <i>Our Group Companies</i> ” on page 215

Term	Description
Independent Directors	Non-executive independent directors on our Board, appointed as per the Companies Act and the Listing Regulations, and as described in “ <i>Our Management</i> ” on page 197
Investor Selling Shareholders	Client Ebene Limited and CVCIGP II Employee Ebene Limited
IPO Committee	The IPO committee of our Company as described in “ <i>Our Management – IPO Committee</i> ” on page 206
“Key Managerial Personnel” or “KMP”	Key managerial personnel of our Company in accordance with Regulation 2(1)(bb) of the SEBI ICDR Regulations as described in “ <i>Our Management – Key Managerial Personnel</i> ” on page 208
Managing Director	A Director of our Company, being Subramonia Sekhar Vasana, as identified under Section 2(54) of the Companies Act
“Memorandum of Association” or “MoA”	Memorandum of association of our Company, as amended
Nomination and Remuneration Committee	Nomination and remuneration committee of our Company, constituted in accordance with the applicable provisions of the Companies Act and the Listing Regulations, as described in “ <i>Our Management – Nomination and Remuneration Committee</i> ” on page 204
Non-executive Director	A director on our Board, as appointed from time to time, other than the Executive Directors and the Managing Director
Plant 1	Manufacturing unit of our Company, situated at Survey No. 26/6, Village Yarandahalli, Jigani Hobli, Anekal Taluk, Bommasandra Industrial Area, Bangalore 560 099, Karnataka
Plant 2	Manufacturing unit of our Company, situated at Plot No. 260/A (P), 261/C and 262/A, Bommasandra Industrial Area, Bommasandra Village, Attibele Hobli, Anekal Taluk, Bengaluru, Karnataka
Plant 3	Manufacturing unit of our Company, situated at Plot No. 1, Bommasandra, Jigani Link Road, Industrial Area, Yarandahally village, Jigani Hobli, Anekal Taluk, Bengaluru, Karnataka
Plant 4	Manufacturing unit of our Company, situated at Plot No. 22-23, Sector – 6, Industrial Estate, I.M.T. Manesar, Gurgaon, Haryana
Plant 5	Manufacturing unit of our Company, situated at Plot No. B-18, Chakan, MIDC, Industrial Area, within village limit of Nighoge Taluka, Khed, Pune, Maharashtra
Plant 6	Manufacturing unit of our Company, situated at Plot No. 18, Sector 9, SIDCUL, Integrated IE Pantnagar, Udham Singh Nagar, Uttarakhand
Plant 7	Registered Office (Manufacturing unit situated at Plot No. 143/A, Jigani Link Road, Bommasandra Industrial Area, Anekal Taluk, Bengaluru 560 105, Karnataka)
Plant 8	Product Development, Quality Systems and Training facility situated at Plot No. 100, Bommasandra, Jigani Link Road, Industrial Area, Jigani Hobli, Bengaluru (Urban), Karnataka
Plant 9	Manufacturing unit of our Company, situated at 125-126, 4 th Phase, Bommasandra, Jigani Link Road, Industrial Area, Yarandahalli Village, Jigani Hobli, Anekal Taluk, Bengaluru, Karnataka
Plant 10	Manufacturing unit of our Company, situated at Plot No. 102, Bommasandra, Jigani Link Road, Anekal Taluk, Bengaluru Urban District, Karnataka
Plant 11	Manufacturing unit of our Company, situated at Plot No. 48, Bidadi Industrial Area, Phase-II, Sector-II, Shyanumangala, Bidadi Hobli, Ramanagara Taluk, Bengaluru, Karnataka
Plant 12	Manufacturing unit of our Company, situated at No. 143, B-8, C-2, B-8 (Part), Survey number 77, Bommasandra Industrial Area, Hebbagodi Village, Hobli, Bengaluru, Karnataka and Site No A1, Khata No 344, Hebbagodi Village, Attibele Hobli, Anekal Taluk, Bangalore 560099, Karnataka. which was transferred to our Company, with effect from April 1, 2017, pursuant to the amalgamation of Gearock Forge with our Company
Plant 14	Manufacturing unit of our Company, situated at Plot No. 34, 35 and 36, Jigani Industrial Area, II Phase, Jigani Hobli, Anekal Taluk, Bengaluru, Karnataka
Plant 15	Manufacturing unit of our Company situated at Plot No E1-E3, Mascot Industrial Park, Jadavpura Cross Road, Kadi-Vithalapur Highway, Kadi, Distt. Mehsana, Gujarat
Previous Auditor	Previous statutory auditors of the company namely, B S R & Associates LLP, Chartered Accountants
“Promoters” or “Promoter Selling Shareholders”	Subramonia Sekhar Vasana, Fatheraj Singhvi*, Unni Rajagopal Kothenath and Devappa Devaraj <i>*Fatheraj Singhvi is acting in trust for the offer for sale of up to 61,221 Equity Shares by Lalitha Singhvi, up to 62,031 Equity Shares by Praveen Singhvi, up to 62,031 Equity Shares by Lata Singhvi, up to 62,031 Equity Shares by Jayaraj Singhvi, up to 62,031 Equity Shares by Tara Singhvi and up to 62,031 Equity Shares by Indira Singhvi. For details, see “The Offer” and “Capital Structure” on pages 54 and 68, respectively</i>
Promoter Group	Persons and entities constituting the promoter group of our Company in terms of Regulation 2(1)(pp) of the SEBI ICDR Regulations, as disclosed in “ <i>Our Promoters and Promoter Group – Promoter Group</i> ” on page 213
“Registered Office” and “Corporate Office”	Plant 7 situated at Plot No. 143/A, Jigani Link Road, Bommasandra Industrial Area, Anekal Taluk, Bengaluru 560 105, Karnataka, India
“Registrar of Companies” or “RoC”	Registrar of Companies, Karnataka situated at Bangalore
Restated Consolidated Financial Information	The Restated Consolidated Financial Information of the Company and its Subsidiaries comprises of the restated consolidated statement of assets and liabilities as at March 31, 2021, March 31, 2020 and March 31, 2019, the restated consolidated statement of profit and loss (including other comprehensive income), the restated consolidated cash flow statement and the restated consolidated statement of changes in equity for years ended March 31, 2021, March 31, 2020 and March 31, 2019 and the significant accounting policies and explanatory notes prepared in terms of the requirements of Section 26 of Part I of Chapter III of the

Term	Description
	Companies Act, SEBI ICDR Regulations, and the Guidance Note on Reports in Company Prospectuses (Revised 2019) issued by the Institute of Chartered Accountants of India (ICAI), as amended (the “ Guidance Note ”).
Ricardo	Ricardo UK Limited
Ricardo Report	Report titled “ <i>Global Industry Overview and Market Sizing of Specific Powertrain Components</i> ” dated June 4, 2021 issued by Ricardo
Sansera Mauritius	Sansera Engineering Pvt. Ltd., Mauritius
Sansera Sweden	Sansera Sweden AB
Sansera Sweden Plant	Manufacturing Unit of Sansera Sweden situated at 461 38 Trollhättan, Elektroden 4, Sweden
Selling Shareholders	Together, the Promoter Selling Shareholders and the Investor Selling Shareholders
Series A CCPS	Series A compulsorily convertible preference shares of face value of ₹100 each of our Company
Series B CCPS	Series B compulsorily convertible preference shares of face value of ₹100 each of our Company
Shareholders	Shareholders of our Company from time to time
Shareholders Agreement	Shareholders’ agreement dated May 29, 2013, executed between our Company, Client Ebene Limited, CVCIGP II Employee Ebene Limited, Subramonia Sekhar Vasam, Fatheraj Singhvi, Unni Rajagopal Kothenath, Devappa Devaraj, Karthik Das and Anjana Iyer, as amended
Singhvi Family Shareholders	Lalitha Singhvi, Praveen Singhvi, Lata Singhvi, Jayaraj Singhvi, Tara Singhvi and Indira Singhvi
Stakeholders’ Relationship Committee	Stakeholders’ relationship committee of our Company, constituted in accordance with the applicable provisions of the Companies Act and the Listing Regulations and as described in “ <i>Our Management – Stakeholders’ Relationship Committee</i> ” on page 205
Subsidiary(ies)	Fitwel, Sansera Mauritius and Sansera Sweden

Offer Related Terms

Term	Description
Abridged Prospectus	Abridged prospectus means a memorandum containing such salient features of a prospectus as may be specified by the SEBI in this behalf
Acknowledgement Slip	The slip or document issued by a Designated Intermediary(ies) to a Bidder as proof of registration of the Bid cum Application Form
“Allot”, “Allotment” or “Allotted”	Unless the context otherwise requires, transfer of the Equity Shares pursuant to the Offer to successful Bidders
Allotment Advice	Note or advice or intimation of Allotment sent to the successful Bidders who have been or are to be Allotted the Equity Shares after the Basis of Allotment has been approved by the Designated Stock Exchange
Allottee	A successful Bidder to whom the Equity Shares are Allotted
Anchor Investor	A Qualified Institutional Buyer, applying under the Anchor Investor Portion in accordance with the requirements specified in the SEBI ICDR Regulations and this Red Herring Prospectus and who has Bid for an amount of at least ₹100 million. For further details, see “ <i>Offer Procedure</i> ” on page 344
Anchor Investor Allocation Price	Price at which Equity Shares will be allocated to Anchor Investors in terms of this Red Herring Prospectus and the Prospectus, which will be decided by our Company with the consent of the Investor Selling Shareholders, in consultation with the BRLMs and the Promoter Selling Shareholders during the Anchor Investor Bid/ Offer Period
Anchor Investor Application Form	Form used by an Anchor Investor to make a Bid in the Anchor Investor Portion and which will be considered as an application for Allotment in terms of this Red Herring Prospectus and the Prospectus
Anchor Investor Bid/ Offer Period	The day being one Working Day prior to the Bid/ Offer Opening Date, on which Bids by Anchor Investors shall be submitted and allocation to Anchor Investors shall be completed
Anchor Investor Offer Price	Final price at which the Equity Shares will be Allotted to Anchor Investors in terms of this Red Herring Prospectus and the Prospectus, which price will be equal to or higher than the Offer Price but not higher than the Cap Price. The Anchor Investor Offer Price will be decided by our Company in consultation with the BRLMs and the Selling Shareholders.
Anchor Investor Portion	Up to 60% of the QIB Portion which may be allocated by our Company with the consent of the Investor Selling Shareholders in consultation with the BRLMs and the Promoter Selling Shareholders, to Anchor Investors on a discretionary basis. One-third of the Anchor Investor Portion shall be reserved for domestic Mutual Funds, subject to valid Bids being received from domestic Mutual Funds at or above the Anchor Investor Allocation Price, in accordance with the SEBI ICDR Regulations
“Application Supported by Blocked Amount” or “ASBA”	Application, whether physical or electronic, used by ASBA Bidders to make a Bid and authorizing an SCSB to block the Bid Amount in the ASBA Account and will include applications made by RIBs using the UPI Mechanism where the Bid Amount will be blocked upon acceptance of UPI Mandate Request by RIBs
ASBA Account	Bank account maintained with an SCSB by an ASBA Bidder, as specified in the ASBA Form submitted by ASBA Bidders for blocking the Bid Amount mentioned in the relevant ASBA Form and includes the account of an RIB which is blocked upon acceptance of a UPI Mandate Request made by the RIBs using the UPI Mechanism
ASBA Bid	A Bid made by an ASBA Bidder
ASBA Bidder(s)	All Bidders except Anchor Investors

Term	Description
ASBA Form	Application form, whether physical or electronic, used by ASBA Bidders which will be considered as the application for Allotment in terms of this Red Herring Prospectus and the Prospectus
Bankers to the Offer	Collectively, Escrow Collection Bank, Public Offer Bank, Sponsor Bank and Refund Bank, as the case may be
Basis of Allotment	Basis on which Equity Shares will be Allotted to successful Bidders under the Offer and which is described in "Offer Procedure" on page 344
"Bid" or "Bidding"	Indication to make an offer during the Bid/ Offer Period by an ASBA Bidder pursuant to submission of the ASBA Form, or during the Anchor Investor Bid/ Offer Period by an Anchor Investor, pursuant to submission of the Anchor Investor Application Form, to subscribe to the Equity Shares at a price within the Price Band, including all revisions and modifications thereto as permitted under the SEBI ICDR Regulations and in terms of this Red Herring Prospectus and the Bid cum Application Form. The term "Bidding" shall be construed accordingly
Bid Amount	<p>The highest value of optional Bids indicated in the Bid cum Application Form (less Employee Discount as applicable) and, in the case of Retail Individual Bidders Bidding at the Cut off Price, the Cap Price multiplied by the number of Equity Shares Bid for by such Retail Individual Bidder and mentioned in the Bid cum Application Form (less Retail Discount, if any) and payable by the Bidder or blocked in the ASBA Account of the Bidder, as the case may be, upon submission of the Bid.</p> <p>Eligible Employees applying in the Employee Reservation Portion can apply at the Cut off Price and the Bid Amount shall be Cap Price net of Employee Discount, multiplied by the number of Equity Shares Bid for by such Eligible Employee and mentioned in the Bid cum Application Form. The maximum Bid Amount under the Employee Reservation Portion by an Eligible Employee shall not exceed ₹500,000 (net of Employee Discount). However, the initial Allotment to an Eligible Employee in the Employee Reservation Portion shall not exceed ₹200,000 (net of Employee Discount) in value. Only in the event of an under-subscription in the Employee Reservation Portion post the initial allotment, such unsubscribed portion may be Allotted on a proportionate basis to Eligible Employees Bidding in the Employee Reservation Portion, for a value in excess of ₹200,000 (net of Employee Discount), subject to the total Allotment to an Eligible Employee not exceeding ₹500,000 (net of Employee Discount) in value</p>
Bid cum Application Form	Anchor Investor Application Form or the ASBA Form, as the context requires
Bid Lot	[●] Equity Shares and in multiples of [●] Equity Shares thereafter
Bid/ Offer Closing Date	<p>Except in relation to any Bids received from the Anchor Investors, the date after which the Designated Intermediaries will not accept any Bids, which shall be notified in all editions of Financial Express, an English national daily newspaper, Delhi edition of Jansatta, a Hindi national daily newspaper and Bangalore edition of Vishwavani, a Kannada daily newspaper (Kannada being the regional language of Karnataka, where our Registered Office is located), each with wide circulation, and in case of any such extension, the extended Bid/ Offer Closing Date shall also be notified on the website and terminals of the Syndicate and communicated to the Designated Intermediaries and the Sponsor Bank, as required under the SEBI ICDR Regulations.</p> <p>Our Company with the consent of the Investor Selling Shareholders in consultation with the BRLMs and the Promoter Selling Shareholders may, consider closing the Bid/ Offer Period for QIBs one Working Day prior to the Bid/ Offer Closing Date in accordance with the SEBI ICDR Regulations and the UPI Circulars. In case of any revision, the extended Bid/ Offer Closing Date shall be widely disseminated by notification to the Stock Exchanges, and also be notified on the websites of the BRLMs and at the terminals of the Syndicate, which shall also be notified in an advertisement in same newspapers in which the Bid/ Offer Opening Date was published, as required under the SEBI ICDR Regulations.</p>
Bid/ Offer Opening Date	Except in relation to any Bids received from the Anchor Investors, the date on which the Designated Intermediaries shall start accepting Bids, which shall be notified in all editions of Financial Express, an English national daily newspaper, Delhi edition of Jansatta, a Hindi national daily newspaper and Bangalore edition of Vishwavani, a Kannada daily newspaper (Kannada being the regional language of Karnataka, where our Registered Office is located), each with wide circulation
Bid/ Offer Period	Except in relation to Anchor Investors, the period between the Bid/ Offer Opening Date and the Bid/ Offer Closing Date, inclusive of both days, during which prospective Bidders can submit their Bids, including any revisions thereof, in accordance with the SEBI ICDR Regulations
Bidder	Any prospective investor who makes a Bid pursuant to the terms of this Red Herring Prospectus and the Bid cum Application Form and unless otherwise stated or implied, includes an Anchor Investor
Bidding Centres	Centres at which the Designated Intermediaries shall accept the ASBA Forms, i.e., Designated Branches for SCSBs, Specified Locations for the Syndicate, Broker Centres for Registered Brokers, Designated RTA Locations for RTAs and Designated CDP Locations for CDPs
Book Building Process	Book building process, as provided in Schedule XIII of the SEBI ICDR Regulations, in terms of which the Offer is being made
"Book Running Lead Managers" or "BRLMs"	The book running lead managers to the Offer, namely, I-Sec, IIFL and Nomura
Broker Centres	<p>Centres notified by the Stock Exchanges where ASBA Bidders can submit the ASBA Forms to a Registered Broker.</p> <p>The details of such Broker Centres, along with the names and contact details of the Registered Brokers are available on the respective websites of the Stock Exchanges (www.bseindia.com and www.nseindia.com)</p>

Term	Description
“CAN” or “Confirmation of Allocation Note”	Notice or intimation of allocation of the Equity Shares sent to Anchor Investors, who have been allocated the Equity Shares, on or after the Anchor Investor Bid/ Offer Period
Cap Price	Higher end of the Price Band, above which the Offer Price and the Anchor Investor Offer Price will not be finalised and above which no Bids will be accepted
Cash Escrow and Sponsor Bank Agreement	Agreement dated September 6, 2021 amongst our Company, the Selling Shareholders, the Registrar to the Offer, the BRLMs, the Sponsor Bank, the Escrow Collection Bank, the Public Offer Bank and the Refund Bank, for appointment of the Sponsor Bank in accordance with the UPI Circulars, collection of the Bid Amounts and where applicable, remitting refunds (if any) on the terms and conditions thereof
Client ID	Client identification number maintained with one of the Depositories in relation to demat account
“Collecting Depository Participant” or “CDP”	A depository participant as defined under the Depositories Act, 1996 registered with SEBI and who is eligible to procure Bids at the Designated CDP Locations in terms of circular no. CIR/CFD/POLICYCELL/11/2015 dated November 10, 2015 issued by SEBI as per the list available on the websites of the Stock Exchanges
Cut-off Price	Offer Price, finalised by our Company in consultation with the BRLMs and the Selling Shareholders, which shall be any price within the Price Band. Only Retail Individual Bidders Bidding in the Retail Portion and Eligible Employees under the Employee Reservation Portion are entitled to Bid at the Cut-off Price. QIBs and Non-Institutional Bidders are not entitled to Bid at the Cut-off Price
Demographic Details	The demographic details of the Bidders including the Bidders’ address, name of the Bidders’ father/husband, investor status, occupation, bank account details and UPI ID, wherever applicable
Designated Branches	Such branches of the SCSBs which shall collect the ASBA Forms, a list of which is available on the website of SEBI at https://www.sebi.gov.in/sebiweb/other/OtherAction.do?doRecognised=yes or at such other website as may be prescribed by SEBI from time to time
Designated CDP Locations	Such locations of the CDPs where Bidders can submit the ASBA Forms. The details of such Designated CDP Locations, along with names and contact details of the Collecting Depository Participants eligible to accept ASBA Forms are available on the respective websites of the Stock Exchanges (www.bseindia.com and www.nseindia.com), as updated from time to time
Designated Date	The date on which the Escrow Collection Bank(s) transfers funds from the Escrow Account to the Public Offer Account or the Refund Account, as the case may be, and the instructions are issued to the SCSBs (in case of RIBs using UPI Mechanism, instruction issued through the Sponsor Bank) for the transfer of amounts blocked by the SCSBs in the ASBA Accounts to the Public Offer Account or the Refund Account, as the case may be, in terms of this Red Herring Prospectus following which Equity Shares will be Allotted in the Offer
Designated Intermediary(ies)	In relation to ASBA Forms submitted by RIBs by authorising an SCSB to block the Bid Amount in the ASBA Account, Designated Intermediaries shall mean SCSBs. In relation to ASBA Forms submitted by RIBs where the Bid Amount will be blocked upon acceptance of UPI Mandate Request by such RIB using the UPI Mechanism, Designated Intermediaries shall mean Syndicate, sub-syndicate/agents, Registered Brokers, CDPs and RTAs. In relation to ASBA Forms submitted by QIBs and Non-Institutional Bidders, Designated Intermediaries shall mean Syndicate, Sub-Syndicate/ agents, SCSBs, Registered Brokers, the CDPs and RTAs
Designated RTA Locations	Such locations of the RTAs where Bidders can submit the ASBA Forms to RTAs. The details of such Designated RTA Locations, along with names and contact details of the RTAs eligible to accept ASBA Forms are available on the respective websites of the Stock Exchanges (www.bseindia.com and www.nseindia.com)
Designated Stock Exchange	BSE
“Draft Red Herring Prospectus” or “DRHP”	The draft red herring prospectus dated June 9, 2021 issued in accordance with the SEBI ICDR Regulations, which did not contain complete particulars of the price at which the Equity Shares will be Allotted and the size of the Offer
Employee Discount	Discount of up to 5.00% (equivalent to ₹[●] per Equity Share) to the Offer Price given to Eligible Employees bidding in the Employee Reservation Portion as may be decided by our Company in consultation with the BRLMs and the Selling Shareholders
Eligible Employees	All or any of the following: (a) a permanent employee of our Company (excluding such employees who are not eligible to invest in the Offer under applicable laws) as of the date of filing of this Red Herring Prospectus with the RoC and who continues to be a permanent employee of our Company, until the submission of the Bid cum Application Form; and (b) a Director of our Company, whether whole time or not, who is eligible to apply under the Employee Reservation Portion under applicable law as on the date of filing of this Red Herring Prospectus with the RoC and who continues to be a Director of our Company, until the submission of the Bid cum Application Form, but not including Directors who either themselves or through their relatives or through any body corporate, directly or indirectly, hold more than 10% of the outstanding Equity Shares of our Company. The maximum Bid Amount under the Employee Reservation Portion by an Eligible Employee shall not exceed ₹500,000 (net of Employee Discount). However, the initial Allotment to an Eligible Employee in the Employee Reservation Portion shall not exceed ₹200,000 (net of Employee Discount). Only in the event of an under-subscription in the Employee Reservation Portion post initial Allotment, such unsubscribed portion may be Allotted on a proportionate basis to Eligible Employees Bidding in the Employee

Term	Description
	Reservation Portion, for a value in excess of ₹200,000 (net of Employee Discount), subject to the total Allotment to an Eligible Employee not exceeding ₹500,000 (net of Employee Discount)
Eligible NRI(s)	NRI(s) from jurisdictions outside India where it is not unlawful to make an Offer or invitation under the Offer and in relation to whom the ASBA Form and this Red Herring Prospectus will constitute an invitation to subscribe to or to purchase the Equity Shares
Employee Reservation Portion	The portion of the Offer being up to [●] Equity Shares aggregating up to ₹90 million, available for allocation to Eligible Employees, on a proportionate basis
Escrow Account	Non-lien and non-interest bearing accounts to be opened with the Escrow Collection Company(s) and in whose favour the Anchor Investors will transfer money through NACH/direct credit/NEFT/RTGS in respect of the Bid Amount when submitting a Bid
Escrow Collection Bank(s)	Bank(s) which are a clearing members and registered with SEBI as banker(s) to an offer, under the Securities and Exchange Board of India (Bankers to an Issue) Regulations, 1994, and with whom the Escrow Account in relation to the Offer for Bids by Anchor Investors, will be opened, in this case being HDFC Bank Limited
First or sole Bidder	Bidder whose name shall be mentioned in the Bid cum Application Form or the Revision Form and in case of joint Bids, whose name shall also appear as the first holder of the beneficiary account held in joint names
Floor Price	Lower end of the Price Band, subject to any revision(s) thereto not being less than the face value of Equity Shares, at or above which the Offer Price and the Anchor Investor Offer Price will be finalised and below which no Bids will be accepted
General Information Document	The General Information Document for investing in public issues prepared and issued in accordance with the SEBI circular no. SEBI/HO/CFD/DIL1/CIR/P/2020/37 dated March 17, 2020 and the UPI Circulars, as amended from time to time. The General Information Document shall be available on the websites of the Stock Exchanges and the BRLMs
I-Sec	ICICI Securities Limited
IIFL	IIFL Securities Limited
Mutual Fund Portion	5% of the Net QIB Portion, or [●] Equity Shares which shall be available for allocation to Mutual Funds only on a proportionate basis, subject to valid Bids being received at or above the Offer Price
Net Offer	The Offer less the Employee Reservation Portion
Net Proceeds	Proceeds of the Offer less Offer expenses. For further details regarding the use of the Net Proceeds and the Offer expenses, see “ <i>Objects of the Offer</i> ” on page 84
Net QIB Portion	The QIB Portion less the number of Equity Shares allocated to the Anchor Investors
Nomura	Nomura Financial Advisory and Securities (India) Private Limited
Non-Institutional Bidders	All Bidders that are not QIBs or Retail Individual Bidders and who have Bid for Equity Shares for an amount of more than ₹200,000 (but not including NRIs other than Eligible NRIs)
Non-Institutional Portion	The portion of the Offer being not less than 15% of the Offer consisting of [●] Equity Shares which shall be available for allocation on a proportionate basis to Non-Institutional Bidders, subject to valid Bids being received at or above the Offer Price
Non-Resident	Person resident outside India, as defined under FEMA
Offer	The initial public offer of up to 17,244,328 Equity Shares for cash at a price of ₹[●] per Equity Shares aggregating up to ₹[●] million through an Offer for Sale by the Selling Shareholders.
Offer Agreement	Agreement dated June 9, 2021 amongst our Company, the Selling Shareholders and the Book Running Lead Managers, pursuant to which certain arrangements have been agreed to in relation to the Offer
Offer for Sale	The offer for sale of the Offered Shares, at the Offer Price aggregating up to ₹[●] million offered for sale by the Selling Shareholders in the Offer
Offer Price	The final price (within the Price Band) (net of Employee Discount and Retail Discount, as applicable) at which Equity Shares will be Allotted to ASBA Bidders in terms of this Red Herring Prospectus and the Prospectus. Equity Shares will be Allotted to Anchor Investors at the Anchor Investor Offer Price which will be decided by our Company in consultation with the BRLMs and the Selling Shareholders in terms of this Red Herring Prospectus and the Prospectus. The Offer Price will be decided by our Company in consultation with the BRLMs and the Selling Shareholders on the Pricing Date in accordance with the Book-building Process and this Red Herring Prospectus.
Offer Proceeds	The proceeds of the Offer. For further information about use of the Offer Proceeds, see “ <i>Objects of the Offer</i> ” on page 84
Offered Shares	Up to 17,244,328 Equity Shares aggregating to ₹[●] million offered by the Selling Shareholders in the Offer for Sale
Price Band	Price band of a minimum price of ₹[●] per Equity Share (Floor Price) and the maximum price of ₹[●] per Equity Share (Cap Price) including any revisions thereof The Price Band and the minimum Bid Lot size for the Offer will be decided by our Company with the consent of the Investor Selling Shareholders in consultation with the BRLMs and the Promoter Selling Shareholders, and will be advertised, at least two Working Days prior to the Bid/ Offer Opening Date, in all editions of Financial Express, an English national daily newspaper, Delhi edition of Jansatta, a Hindi national daily newspaper and Bangalore edition of Vishwavani a Kannada daily newspaper (Kannada being the regional language of Karnataka, where our Registered Office is located) each with wide circulation and shall be made available to the Stock Exchanges for the purpose of uploading on their respective websites
Pricing Date	Date on which our Company in consultation with the BRLMs and the Selling Shareholders, will finalise the Offer Price

Term	Description
Prospectus	Prospectus to be filed with the RoC on or after the Pricing Date in accordance with Section 26 of the Companies Act, and the SEBI ICDR Regulations containing, <i>inter alia</i> , the Offer Price, the size of the Offer and certain other information, including any addenda or corrigenda thereto
Public Offer Account	No lien and non-interest bearing account has been opened with the Public Offer Bank, under Section 40(3) of the Companies Act to receive monies from the Escrow Account and ASBA Accounts on the Designated Date
Public Offer Bank(s)	A bank which is a clearing member and registered with SEBI as a banker to an offer and with which the Public Offer Account will be opened, in this case being HDFC Bank Limited
QIB Portion	The portion of the Offer (including the Anchor Investor Portion) being not more than 50% of the Offer comprising [●] Equity Shares which shall be allocated to QIBs (including Anchor Investors), subject to valid Bids being received at or above the Offer Price or Anchor Investor Offer Price (for Anchor Investors). Our Company with the consent of the Investor Selling Shareholders in consultation with the BRLMs and the Promoter Selling Shareholders may allocate up to 60% of the QIB portion to Anchor Investors on a discretionary basis
“Qualified Institutional Buyers” or “QIBs” or “QIB Bidders”	Qualified institutional buyers as defined under Regulation 2(1)(ss) of the SEBI ICDR Regulations
“Red Herring Prospectus” or “RHP”	This red herring prospectus dated [●] issued in accordance with Section 32 of the Companies Act and the provisions of the SEBI ICDR Regulations, which does not have complete particulars of the Offer Price and the size of the Offer, including any addenda or corrigenda thereto. This Red Herring Prospectus will be filed with the RoC at least three Working Days before the Bid/ Offer Opening Date and will become the Prospectus upon filing with the RoC after the Pricing Date
Refund Account(s)	No lien and non-interest bearing account has been opened with the Refund Bank(s), from which refunds, if any, of the whole or part of the Bid Amount to the Bidders shall be made
Refund Bank(s)	Banker(s) to the Offer and with whom the Refund Account has been opened, in this case being HDFC Bank Limited
Registered Brokers	Stock brokers registered under SEBI (Stock Brokers and Sub-Brokers) Regulations, 1992, as amended with the Stock Exchanges having nationwide terminals, other than the BRLMs and eligible to procure Bids in terms of Circular No. CIR/CFD/14/2012 dated October 4, 2012 issued by SEBI
Registrar Agreement	Agreement dated June 2, 2021 amongst our Company, the Selling Shareholders and the Registrar to the Offer, in relation to the responsibilities and obligations of the Registrar to the Offer pertaining to the Offer
Retail Discount	A discount of ₹[●] on the Offer Price, which may be offered to Retail Individual Bidders.
“Registrar and Share Transfer Agents” or “RTAs”	Registrar and share transfer agents registered with SEBI and eligible to procure Bids at the Designated RTA Locations as per the list available on the websites of the Stock Exchanges, and the UPI Circulars
“Registrar to the Offer” or “Registrar”	Link Intime India Private Limited
“Retail Individual Bidder(s)” or “RIB(s)”	Individual Bidders, who have Bid for the Equity Shares for an amount not more than ₹200,000 (net of Retail Discount, if any) in any of the bidding options in the Offer (including HUFs applying through their <i>karta</i> and Eligible NRIs)
Retail Portion	Portion of the Offer being not less than 35% of the Offer consisting of [●] Equity Shares which shall be available for allocation to Retail Individual Bidders (subject to valid Bids being received at or above the Offer Price), which shall not be less than the minimum Bid Lot subject to availability in the Retail Portion, and the remaining Equity Shares to be Allotted on a proportionate basis
Revision Form	Form used by the Bidders to modify the quantity of the Equity Shares or the Bid Amount in any of their ASBA Form(s) or any previous Revision Form(s). QIB Bidders and Non-Institutional Bidders are not allowed to withdraw or lower their Bids (in terms of quantity of Equity Shares or the Bid Amount) at any stage. Retail Individual Bidders and Eligible Employees Bidding in the Employee Reservation Portion can revise their Bids during the Bid/ Offer Period and withdraw their Bids until Bid/ Offer Closing Date
“Self-Certified Syndicate Bank(s)” or “SCSB(s)”	The banks registered with SEBI, which offer the facility of ASBA services, (i) in relation to ASBA, where the Bid Amount will be blocked by authorising an SCSB, a list of which is available on the website of SEBI at www.sebi.gov.in/sebiweb/other/OtherAction.do?doRecognisedFpi=yes&intmId=34 and updated from time to time and at such other websites as may be prescribed by SEBI from time to time, (ii) in relation to RIBs using the UPI Mechanism, a list of which is available on the website of SEBI at https://sebi.gov.in/sebiweb/other/OtherAction.do?doRecognisedFpi=yes&intmId=40 or such other website as updated from time to time. Applications through UPI in the Offer can be made only through the SCSBs mobile applications (apps) whose name appears on the SEBI website. A list of SCSBs and mobile application, which, are live for applying in public issues using UPI mechanism is appearing in the “list of mobile applications for using UPI in public issues” displayed on the SEBI website. The said list shall be updated on the SEBI website
Share Escrow Agent	Escrow agent to be appointed pursuant to the Share Escrow Agreement, namely, Link Intime India Private Limited
Share Escrow Agreement	Agreement dated September 6, 2021 entered into amongst our Company, the Selling Shareholders and the Share Escrow Agent in connection with the transfer of the Offered Shares by the Selling Shareholders and credit of such Equity Shares to the demat account of the Allottees
Specified Locations	Bidding Centres where the Syndicate shall accept ASBA Forms from Bidders, a list of which is available on the website of SEBI (www.sebi.gov.in) and updated from time to time

Term	Description
Sponsor Bank	HDFC Bank Limited being a Banker to the Offer, appointed by our Company to act as a conduit between the Stock Exchanges and NPCI in order to push the mandate collect requests and / or payment instructions of the RIBs using the UPI Mechanism and carry out other responsibilities, in terms of the UPI Circulars
“Syndicate” or “Members of the Syndicate”	The BRLMs, collectively
Syndicate Agreement	Agreement dated September 6, 2021 entered into amongst our Company, the Selling Shareholders and the Registrar to the Offer, in relation to collection of Bids by the Syndicate
Underwriters	[●]
Underwriting Agreement	Agreement to be entered into amongst our Company, the Selling Shareholders and the Underwriters to be entered into on or after the Pricing Date but prior to filing of the Prospectus with the RoC
UPI	Unified payments interface which is an instant payment mechanism, developed by NPCI
UPI Circulars	SEBI circular number SEBI/HO/CFD/DIL2/CIR/P/2018/138 dated November 1, 2018, SEBI circular number SEBI/HO/CFD/DIL2/CIR/P/2019/50 dated April 3, 2019, SEBI circular number SEBI/HO/CFD/DIL2/CIR/P/2019/76 dated June 28, 2019, SEBI circular number SEBI/HO/CFD/DIL2/CIR/P/2019/85 dated July 26, 2019, SEBI circular number SEBI/HO/CFD/DCR2/CIR/P/2019/133 dated November 8, 2019, SEBI circular number SEBI/HO/CFD/DIL2/CIR/P/2020 dated March 30, 2020, SEBI circular number SEBI/HO/CFD/DIL2/CIR/P/2021/2480/1/M dated March 16, 2021, SEBI circular number SEBI/HO/CFD/DIL2/P/CIR/2021/570 dated June 2, 2021 and any subsequent circulars or notifications issued by SEBI in this regard
UPI ID	ID created on the UPI for single-window mobile payment system developed by the NPCI
UPI Mandate Request	A request (intimating the RIB by way of a notification on the UPI linked mobile application as disclosed by SCSBs on the website of SEBI and by way of an SMS on directing the RIB to such UPI linked mobile application) to the RIB initiated by the Sponsor Bank to authorise blocking of funds on the UPI application equivalent to Bid Amount and subsequent debit of funds in case of Allotment
UPI Mechanism	The bidding mechanism that may be used by an RIB submitted with intermediaries with UPI as a mode of payment in accordance with the UPI Circulars to make an ASBA Bid in the Offer
UPI PIN	Password to authenticate a UPI transaction
Wilful Defaulter	An entity or person categorised as a wilful defaulter by any bank or financial institution or consortium thereof, in terms of regulation 2(1)(III) of the SEBI ICDR Regulations
Working Day	All days on which commercial banks in Mumbai are open for business. In respect of announcement of Price Band and Bid/ Offer Period, Working Day shall mean all days, excluding Saturdays, Sundays and public holidays, on which commercial banks in Mumbai are open for business. In respect of the time period between the Bid/ Offer Closing Date and the listing of the Equity Shares on the Stock Exchanges, “Working Day” shall mean all trading days of the Stock Exchanges, excluding Sundays and bank holidays in India, as per circulars issued by SEBI, including the UPI Circulars

Technical/ Industry Related Terms/ Abbreviations

Term	Description
2W	Two-wheeler
3W	Three-wheeler
ABS	Anti-lock braking system
ACMA	Automotive Component Manufacturers Association
Airbus	Airbus SE
Amtek Auto	Amtek Auto Ltd
Amul Industries	Amul Industries Pvt Ltd
AS	A class of quality management system standards established and maintained by the International Aerospace Quality Group
ASEAN	Association of South East Asian Nations
ATV	All-terrain vehicle
Autodesk	A design, development or prototyping information technology system used by us
“Bajaj” or “Bajaj Auto”	Bajaj Auto Limited
Bajaj Motors	Bajaj Motors Ltd
BEV	Battery electric vehicle
Bharat Forge	Bharat Forge Ltd
Boeing	The Boeing Company
Bosch	Bosch Limited
BMW	BMW AG
BS	Bharat Stage
BS OHSAS	A class of occupational health and safety management best practice standards established and maintained by the British Standards Institution
BS-VI norms	Bharat Stage-VI emission norms, effective April 1, 2020
CAD	Computer aided design
CAE	Computer aided engineering
CAFE	Corporate average fuel economy
CAM	Computer aided manufacturing
Capital Employed	Total assets less Total current liabilities as on the last day of the fiscal year

Term	Description
CBS	Combined braking system
CCI	Competition Commission of India
CNC	Computer numerical control
CNHi	Case New Holland Industrial
Competition Act	Competition Act, 2002
Cost of Materials	The sum of (i) cost of material consumed, (ii) change in inventories of finished goods and work in progress and (iii) conversion charges
Creo	A design, development or prototyping information technology software system used by us
CRISIL Research	CRISIL Research, a division of CRISIL Limited
CSR	Corporate social responsibility
CV	Commercial vehicle
CVT	Continuously variable transmission
Daimler	Daimler Group
DDS	Duty Drawback Scheme, under which an exporter of goods is allowed to take back refund of money to compensate him for excise duty paid on the inputs used in the products exported by him
DLC	Diamond-like carbon
Ducati	Ducati Motor Holding S.P.A.
Duty credit scrip	An export promotion incentive provided by the Government of India to exporters
Dynamics	Dynamatic Technologies Limited
e-2W	Electric two-wheeler
E&CG	Engineering and Capital Goods
EBIT	Earnings before Interest and Tax, calculated as EBITDA less Depreciation and amortisation expense
EBITDA	Earnings before interest, taxes, depreciation and amortisation, is calculated as the sum of (i) Profit for the year, (ii) Total tax expenses, (iii) Depreciation and amortisation expense and (iv) Finance costs
EBITDA Margin	EBITDA divided by Total income
EMS	Environment management systems
EN	A class of quality management system standards relating to aviation, space and defence organizations
Endurance Technologies	Endurance Technologies Ltd
EPCG Scheme	Export Promotion Capital Goods Scheme
Eurozone / Euro Area	A monetary union of 19 of the 28 European Union member states which have adopted the Euro as their common currency
EV	Electric vehicle
FAME	Faster Adoption and Manufacturing of (Hybrid &) Electric Vehicles
FCA/Fiat Chrysler Automobiles	Fiat Chrysler Automobiles N.V., now called Stellantis N.V.
FCEV	Fuel cell electric vehicle
Fiat / Fiat India	Fiat India Automobiles Private Limited
FIE Group	Fuel Instruments and Engineers group of companies
FII	Foreign institutional investor
Fitch	Fitch Ratings, Inc.
FOB	Free on board
Ford	Ford Motor India Pvt Ltd or Ford Motor Company
Fortuna Engineering	Fortuna Engineering Private Limited
GAAR	General Anti Avoidance Rules
GDP	Gross domestic product
General Motors / GM	General Motors India Pvt Ltd
GKN Aerospace	GKN Aerospace Sweden AB
GVW	Gross vehicle weight
Harley Davidson	Harley Davidson Motor Company India Private Limited
HCV	Heavy commercial vehicle
Hero / Hero Motocorp	Hero Motocorp Ltd.
HLA	Hydraulic lash adjuster
HMSI	Honda Motorcycle and Scooter India Pvt. Ltd.
Honda/ Honda Cars	Honda Cars India Limited
HSIIDC	Haryana State Industrial and Infrastructure Development Corporation
Husqvarna	Husqvarna Motorcycles GmbH
Hyundai	Hyundai Motor India Limited
IATF	International Automotive Task Force
ICE	Internal combustion engine
ICRA	ICRA Limited
IDC	Industrial development corporation
iLogic	A design information technology system used by us that is provided by Autodesk
IMF	International Monetary Fund
India Ratings	India Ratings and Research Private Limited
ISO/TS	Class of quality management system standards relating to the automotive supply chain
IT	Information technology
JCB	JCB India Limited
Kalyani Forge	Kalyani Forge Ltd

Term	Description
KIADB	Karnataka Industrial Areas Development Board
KTM	KTM AG
LCV	Light commercial vehicle
LED	Light-emitting diode
Light Vehicle(s)	Passenger vehicles with gross vehicle weight of 3.5 tonnes or less
Linamar	Linamar Corporation
LoI	Letter of intent
Magal Tech	Magal Engg Tech Pvt Ltd
Mahindra CIE	Mahindra CIE Automotive Ltd
MAN	MAN SE
Maruti Suzuki	Maruti Suzuki India Limited
MCLR	Marginal cost of funds based lending rate
MEIS	Merchandise Exports from India Scheme, a scheme (discontinued w.e.f. January 1, 2021) introduced to provide rewards to exporters to offset infrastructure inefficiencies and associated costs in export of goods, especially those having high export intensity, employment potential and ability to enhance India's export competitiveness
MHCV	Medium and heavy commercial vehicle
Micro Turners	Micro Turners Pvt Ltd
Minitab	A system that helps businesses increase efficiency and improve quality through smart data analysis
Modern Automotives	Modern Automotives Ltd
Motori Minarelli	Motori Minarelli SpA
NCI	Non-controlling interest
Net Debt	The sum of (i) current borrowings, (ii) non-current borrowings, (iii) current maturities of non-current borrowings and (iv) accrued interest less (i) Cash and cash equivalents and (ii) Bank balances other than cash and cash equivalents
Net Debt to Equity Ratio	Net Debt divided by Total equity
Net worth	Total equity attributable to owners of the company less Capital reserve
NOx	Nitrogen oxides
OEM	Original equipment manufacturer
OICA	International Organization of Motor Vehicle Manufacturers
PLI Scheme	Production Linked Incentive Scheme, a scheme providing producers in various industries with incentives to boost domestic manufacturing and exports; a PLI scheme for the automotive components industry is pending notification from the Government of India
PM	Particulate matter
Polaris	Polaris Industries Inc.
PSA	PSA Group, a French multinational manufacturer of automobiles and motorcycles sold under the Peugeot, Citroen, DS, Opel and Vauxhall brands.
PV	Passenger vehicle
QFORM	A professional engineering software used for simulation, analysis and optimisation of metal forming processes providing excellent reliability
RBI	Reserve Bank of India
RICO Auto	RICO Auto Ltd
RK Thailand	RK Thailand Limited
RODTEP Scheme	Remission of Duties and Taxes on Export Products Scheme, a scheme introduced to replace MEIS and reimburse taxes and duties incurred by exporters w.e.f. January 1, 2021 with the aim to make Indian products cost-competitive and create a level playing field for Indian exporters in the global market
Royal Enfield	Royal Enfield Co. Ltd
RPM	Rotations per minute
SAARC	South Asian Association for Regional Cooperation
SCADA	Supervisory control & data acquisition
SAP	SAP Solutions
Scania	A Swedish manufacturer of commercial vehicles, specifically heavy trucks and buses. It also manufactures diesel engines for heavy vehicles as well as marine and general industrial applications
SIAM	Society of Indian Automobile Manufacturers
SPM	Special purpose machine
SPQCD	Safety, productivity, quality, cost and delivery
Stellantis	Stellantis N.V.
takt time	The average time between the start of production of one piece of component and the start of production of the next piece
Tata Motors / Tata	Tata Motors Ltd
Tecnomatrix	A design, fabrication and certification of checking fixtures for all types of parts for the automotive and the aeronautics sectors
ThyssenKrupp	ThyssenKrupp Automotive AG
Tier-1	Suppliers that supply directly to OEMs
Toyota	Toyota Kirloskar Motor Private Limited
TPM	Total productive maintenance
Triumph Motorcycles	Triumph Motorcycles Limited

Term	Description
TVS	TVS Motor Company Limited
UEPPCB	Uttarakhand Environment Protection and Pollution Control Board
Union Budget	Union Budget 2018
UKAS	The United Kingdom Accreditation Service, being the national accreditation body for the United Kingdom to assess organisations that provide certification, testing, inspection and calibration services
UV	Utility vehicle
Volkswagen / VW	Volkswagen India Private Limited
Yamaha	Yamaha Group
Yamaha India	India Yamaha Motor Private Limited

Conventional and General Terms or Abbreviations

Term	Description
“₹”, “Rs.”, “Rupees” or “INR”	Indian Rupees
ACH	Automated Clearing House
AIFs	Alternative Investments Funds, as defined in and registered with SEBI under the Securities and Exchange Board of India (Alternative Investments Funds) Regulations, 2012
BSE	BSE Limited
CAGR	Compounded Annual Growth Rate
“Calendar Year” or “CY”	A calendar year is a one-year period that begins on January 1 and ends on December 31, based on the commonly-used Gregorian calendar
Category I AIF	AIFs who are registered as “Category I Alternative Investment Funds” under the SEBI AIF Regulations
Category I FPIs	FPIs who are registered as “Category I Foreign Portfolio Investors” under the SEBI FPI Regulations
Category II AIF	AIFs who are registered as “Category II Alternative Investment Funds” under the SEBI AIF Regulations
Category II FPIs	FPIs who are registered as “Category II Foreign Portfolio Investors” under the SEBI FPI Regulations
Category III AIF	AIFs who are registered as “Category III Alternative Investment Funds” under the SEBI AIF Regulations
Copyright Act	The Copyright Act, 1957
CDSL	Central Depository Services (India) Limited
CIN	Corporate Identity Number
Civil Code	The Code of Civil Procedure, 1908
Companies Act	Companies Act, 2013, along with the relevant rules, clarifications and modifications made thereunder
Companies Act, 1956	Companies Act, 1956, along with the relevant rules made thereunder
Consolidated FDI Policy	The Consolidated FDI Policy Circular 2017, issued by the Department of Industrial Policy and Promotion, Ministry of Commerce and Industry, Government of India
Depositories	NSDL and CDSL
Depositories Act	The Depositories Act, 1996
DIN	Director Identification Number
DPIIT	Department for Promotion of Industry and Internal Trade, Ministry of Commerce and Industry, Government of India (earlier known as the Department of Industrial Policy and Promotion)
DP ID	Depository Participant Identification
DP/ Depository Participant	Depository participant as defined under the Depositories Act
ECL	Expected credit losses
EGM	Extraordinary General Meeting
EPFMP Act	Employees’ Provident Funds and Miscellaneous Provisions Act, 1952
ESI Act	Employees State Insurance Act, 1948
EPS	Earnings Per Share
“Euro” or “EURO”	Euro, the official currency of the Eurozone
FCNR	Foreign Currency Non-Resident
FDI	Foreign direct investment
FEMA	Foreign Exchange Management Act, 1999, read with rules and regulations thereunder
FEMA Non-Debt Instruments Rules	Foreign Exchange Management (Non-debt Instruments) Rules, 2019 issued by the Ministry of Finance, GoI
FEMA Regulations	The erstwhile Foreign Exchange Management (Transfer or Issue of Security by a Person Resident outside India) Regulations, 2017
FIR	First Information Report
“Financial Year” or “Fiscal” or “FY”	Unless stated otherwise, the period of 12 months ending March 31 of that particular year
FPI(s)	Foreign portfolio investors as defined under the SEBI FPI Regulations
FVCI(s)	Foreign venture capital investors as defined and registered under the SEBI FVCI Regulations
GAAR	General Anti Avoidance Rules
Gazette	Gazette of India
“GoI”, “Government” or “Central Government”	Government of India
GST	Goods and Services Tax
HUF	Hindu Undivided Family(ies)
IBC	Insolvency and Bankruptcy Code, 2016, as amended unless stated otherwise
IFRS	International Financial Reporting Standards

Term	Description
IFSC	Indian Financial System Code
“Ind AS” or “Indian Accounting Standards”	Indian Accounting Standards referred to in the Companies Act and notified under Section 133 of the Companies Act read with the Companies (Indian Accounting Standards) Rules, 2015, as amended
India	Republic of India
Indian GAAP	Accounting Standards notified under Section 133 of the Companies Act, 2013, read together with Rule 7 of the Companies (Accounts) Rules, 2014 and Companies (Accounting Standards) Amendment Rules, 2016
IPO	Initial public offering
IRDAI	Insurance Regulatory and Development Authority of India
IST	Indian Standard Time
IT	Information Technology
IT Act	The Income Tax Act, 1961
ITGC	Information technology general control
Listing Regulations	Securities and Exchange Board of India (Listing Obligations and Disclosure Requirements) Regulations, 2015
MCA	Ministry of Corporate Affairs, Government of India
MUR	Mauritian Rupee, the official currency of Mauritius
MSME	Micro, small or medium enterprise
Mutual Fund (s)	Mutual Fund(s) means mutual funds registered under the SEBI (Mutual Funds) Regulations, 1996
N/A	Not applicable
NACH	National Automated Clearing House
“NAV” or “Net Asset Value”	Net worth divided by weighted average number of equity shares outstanding in the year
NBFC	Non-banking financial company
NEFT	National Electronic Funds Transfer
NGN	Nigerian Naira, the official currency of Nigeria
NPCI	National Payments Corporation of India
NRI	Person resident outside India, who is a citizen of India or a person of Indian origin, and shall have the meaning ascribed to such term in the Foreign Exchange Management (Deposit) Regulations, 2016 or an overseas citizen of India cardholder within the meaning of section 7(A) of the Citizenship Act, 1955
NRE Account	Non-resident rupee account
NRO Account	Non-resident ordinary account
NRV	Net realisable value
NSDL	National Securities Depository Limited
NSE	National Stock Exchange of India Limited
OCB/Overseas Corporate Body	A company, partnership, society or other corporate body owned directly or indirectly to the extent of at least 60% by NRIs including overseas trusts, in which not less than 60% of beneficial interest is irrevocably held by NRIs directly or indirectly and which was in existence on October 3, 2003 and immediately before such date had taken benefits under the general permission granted to OCBs under FEMA. OCBs are not allowed to invest in the Offer
OSP	Other Service Provider
p.a.	Per annum
P/E	Price/earnings
P/E Ratio	Price/earnings ratio
PAN	Permanent account number
PAT	Profit after tax
PAT Margin	Profit for the year divided by total income
RBI	The Reserve Bank of India
RBI Act	The Reserve Bank of India Act, 1934
RoCE	Return on Capital Employed
RoNW	Return on Net Worth
RTA	Registrars to an Issue and Share Transfer Agents
Regulation S	Regulation S under the U.S. Securities Act
RTGS	Real Time Gross Settlement
SCRA	Securities Contracts (Regulation) Act, 1956
SCRR	Securities Contracts (Regulation) Rules, 1957
SEK	Swedish Krona, the official currency of Sweden
SGD	Singapore Dollar, the official currency of Singapore
SEBI	Securities and Exchange Board of India constituted under the SEBI Act
SEBI Act	Securities and Exchange Board of India Act, 1992
SEBI AIF Regulations	Securities and Exchange Board of India (Alternative Investments Funds) Regulations, 2012
SEBI FPI Regulations	Securities and Exchange Board of India (Foreign Portfolio Investors) Regulations, 2019
SEBI FVCI Regulations	SEBI (Foreign Venture Capital Investors) Regulations 2000
SEBI ICDR Regulations	Securities and Exchange Board of India (Issue of Capital and Disclosure Requirements) Regulations, 2018, as amended
SEBI Intermediaries Regulations	Securities and Exchange Board of India (Intermediaries) Regulations, 2008
SEBI Merchant Banker Regulations	SEBI (Merchant Bankers) Regulations, 1992

Term	Description
SEBI SBEB Regulations	Securities and Exchange Board of India (Share Based Employee Benefits and Sweat Equity) Regulations, 2021
SEBI VCF Regulations	The <i>erstwhile</i> Securities and Exchange Board of India (Venture Capital Fund) Regulations, 1996 as repealed pursuant to the SEBI AIF Regulations
State Government	The government of a state in India
Stock Exchanges	BSE and NSE
STT	Securities transaction tax
Systemically Important Non-Banking Financial Company	Systemically important non-banking financial company as defined under Regulation 2(1)(iii) of the SEBI ICDR Regulations
Takeover Regulations	Securities and Exchange Board of India (Substantial Acquisition of Shares and Takeovers) Regulations, 2011
TAN	Tax deduction account number
Trade Mark Act	Trade Mark Act, 1999
U.S. GAAP	Generally Accepted Accounting Principles in the United States
U.S. Securities Act	U.S. Securities Act of 1933, as amended
“U.S.”, “USA” or “United States”	United States of America
“USD” or “US\$” or “\$”	United States Dollars, the official currency of the United States
VCFs	Venture Capital Funds as defined in and registered with SEBI under the SEBI VCF Regulations

OFFER DOCUMENT SUMMARY

The following is a general summary of the terms of the Offer and is neither exhaustive, nor purports to contain a summary of all the disclosures in this Red Herring Prospectus or the Prospectus, or all details relevant to prospective investors. This summary should be read in conjunction with, and is qualified in its entirety by, the more detailed information appearing elsewhere in this Red Herring Prospectus, including “Risk Factors”, “Objects of the Offer”, “Our Business”, “Industry Overview”, “Capital Structure”, “The Offer”, “Financial Statements”, “Outstanding Litigation and Material Developments”, “Offer Procedure” and “Description of Equity Shares and Terms of Articles of Association” on pages 22, 84, 147, 94, 68, 54, 219, 316, 344 and 360 respectively.

Primary business of our Company and the industry in which it operates	<p>Primary business of our Company:</p> <p>We are an engineering-led integrated manufacturer of complex and critical precision engineered components across automotive and non-automotive sectors. Within the automotive sector, we manufacture and supply a range of precision forged and machined components and assemblies that are critical for engine, transmission, suspension, braking, chassis and other systems for the two-wheeler, passenger vehicle and commercial vehicle verticals. Within the non-automotive sector, we manufacture and supply a range of precision components for the aerospace, off-road, agriculture and other segments, including engineering and capital goods. We supply most of our products directly to OEMs in finished condition, resulting in significant value addition by us.</p> <p>For further details, see “Our Business” on page 147.</p> <p>The industry in which our Company operates:</p> <p>In India, auto component production (which includes sale to OEMs, exports, and replacement market) increased at a CAGR of 3.4% over fiscals 2016-21, to ₹3,013 billion from ₹2,553 billion. CRISIL Research expects the auto component industry’s revenue to be led by OEM demand, which is expected to log a CAGR of 11.9% over fiscals 2021-26, to reach ₹5,284 billion. Production growth and higher outsourcing to auto component players by OEMs will drive OEM demand. (Source: the CRISIL Report).</p> <p>For further details, see “Industry Overview – Review and outlook for the Indian auto component sector” on page 119</p>																																																												
Name of Promoters	Subramonia Sekhar Vasam, Fatheraj Singhvi, Unni Rajagopal Kothenath and Devappa Devaraj																																																												
Offer size	<p>Offer of up to 17,244,328 Equity Shares for cash at a price of ₹[●] per Equity Share aggregating up to ₹[●] million. The Offer shall constitute [●]% of the post-Offer paid-up Equity Share capital of our Company.</p> <p>The Offer includes a reservation of up to [●] Equity Shares, aggregating up to ₹[●] million, net of Employee Discount and Retail Discount (if any), for subscription by Eligible Employees. The Offer less the Employee Reservation Portion is the Net Offer. The Net Offer shall constitute [●] % of the post-Offer paid-up equity share capital of our Company. For further details, see “Offer Structure” on page 41</p>																																																												
Objects of the Offer	The objects of the Offer are to (i) to carry out the Offer for Sale of up to 17,244,328 Equity Shares by the Selling Shareholders; and (ii) achieve the benefits of listing the Equity Shares on the Stock Exchanges. For further details, see “Objects of the Offer” on page 84																																																												
Aggregate pre-Offer shareholding of our Promoters, Promoter Group and Selling Shareholders as a percentage of our fully diluted paid-up Equity Share capital	<p>The aggregate pre-Offer shareholding of our Promoters and Promoter Group as a percentage of the pre-Offer paid-up Equity Share capital of our Company is set out below:</p> <table border="1" style="width: 100%; border-collapse: collapse;"> <thead> <tr> <th style="width: 5%;">S. No.</th> <th style="width: 45%;">Name</th> <th style="width: 20%;">No. of Equity Shares on a fully diluted basis*</th> <th style="width: 30%;">Percentage of the pre-Offer Equity Share Capital on a fully diluted basis* (%)</th> </tr> </thead> <tbody> <tr> <td colspan="4">Promoter/ Promoter Selling Shareholders (A)</td> </tr> <tr> <td>1.</td> <td>Subramonia Sekhar Vasam</td> <td style="text-align: right;">12,307,600</td> <td style="text-align: right;">22.90</td> </tr> <tr> <td>2.</td> <td>Unni Rajagopal Kothenath</td> <td style="text-align: right;">3,416,925</td> <td style="text-align: right;">6.36</td> </tr> <tr> <td>3.</td> <td>Fatheraj Singhvi **</td> <td style="text-align: right;">3,366,925</td> <td style="text-align: right;">6.27</td> </tr> <tr> <td>4.</td> <td>Devappa Devaraj</td> <td style="text-align: right;">2,747,750</td> <td style="text-align: right;">5.11</td> </tr> <tr> <td colspan="2">Total holdings of the Promoters</td> <td style="text-align: right;">21,839,200</td> <td style="text-align: right;">40.64</td> </tr> <tr> <td colspan="4">Promoter Group (B)</td> </tr> <tr> <td>1.</td> <td>Devappa Devaraj HUF</td> <td style="text-align: right;">669,175</td> <td style="text-align: right;">1.25</td> </tr> <tr> <td>2.</td> <td>P. Singhvi Charitable Trust</td> <td style="text-align: right;">50,000</td> <td style="text-align: right;">0.09</td> </tr> <tr> <td colspan="2">Total holding of Promoter and Promoter Group</td> <td style="text-align: right;">22,558,375</td> <td style="text-align: right;">41.98</td> </tr> <tr> <td colspan="4">Investor Selling Shareholders (C)</td> </tr> <tr> <td colspan="2">Client Ebene Limited</td> <td style="text-align: right;">18,190,250</td> <td style="text-align: right;">33.85</td> </tr> <tr> <td colspan="2">CVCIGP II Employee Ebene Limited</td> <td style="text-align: right;">10,188,425</td> <td style="text-align: right;">18.96</td> </tr> <tr> <td colspan="2">Total Shareholding of the Selling Shareholders (A+C)</td> <td style="text-align: right;">50,217,875</td> <td style="text-align: right;">93.45</td> </tr> </tbody> </table> <p>*Assuming exercise of vested employee stock options ** Fatheraj Singhvi is acting in trust in relation to 2,030,000 Equity Shares held by the Singhvi Family Shareholders. For details, see “The Offer” and “Capital Structure” on pages 54 and 68, respectively.</p>	S. No.	Name	No. of Equity Shares on a fully diluted basis*	Percentage of the pre-Offer Equity Share Capital on a fully diluted basis* (%)	Promoter/ Promoter Selling Shareholders (A)				1.	Subramonia Sekhar Vasam	12,307,600	22.90	2.	Unni Rajagopal Kothenath	3,416,925	6.36	3.	Fatheraj Singhvi **	3,366,925	6.27	4.	Devappa Devaraj	2,747,750	5.11	Total holdings of the Promoters		21,839,200	40.64	Promoter Group (B)				1.	Devappa Devaraj HUF	669,175	1.25	2.	P. Singhvi Charitable Trust	50,000	0.09	Total holding of Promoter and Promoter Group		22,558,375	41.98	Investor Selling Shareholders (C)				Client Ebene Limited		18,190,250	33.85	CVCIGP II Employee Ebene Limited		10,188,425	18.96	Total Shareholding of the Selling Shareholders (A+C)		50,217,875	93.45
S. No.	Name	No. of Equity Shares on a fully diluted basis*	Percentage of the pre-Offer Equity Share Capital on a fully diluted basis* (%)																																																										
Promoter/ Promoter Selling Shareholders (A)																																																													
1.	Subramonia Sekhar Vasam	12,307,600	22.90																																																										
2.	Unni Rajagopal Kothenath	3,416,925	6.36																																																										
3.	Fatheraj Singhvi **	3,366,925	6.27																																																										
4.	Devappa Devaraj	2,747,750	5.11																																																										
Total holdings of the Promoters		21,839,200	40.64																																																										
Promoter Group (B)																																																													
1.	Devappa Devaraj HUF	669,175	1.25																																																										
2.	P. Singhvi Charitable Trust	50,000	0.09																																																										
Total holding of Promoter and Promoter Group		22,558,375	41.98																																																										
Investor Selling Shareholders (C)																																																													
Client Ebene Limited		18,190,250	33.85																																																										
CVCIGP II Employee Ebene Limited		10,188,425	18.96																																																										
Total Shareholding of the Selling Shareholders (A+C)		50,217,875	93.45																																																										

Select Financial Information	(₹ in million, except per share data)																					
	Particulars	As at March 31																				
		2021	2020	2019																		
	Equity Share capital	93.87	93.87	93.87																		
	Total equity	8,887.41	7,768.56	6,945.18																		
	Total borrowings ⁽¹⁾	5,497.49	6,367.77	5,953.63																		
	Total Income	15,723.64	14,731.39	16,408.09																		
	EBITDA ⁽²⁾	2,952.14	2,406.66	2,919.86																		
	Profit attributable to owners of the company	1,079.86	803.10	962.13																		
	Earnings per Equity Share ⁽³⁾																					
	Basic ⁽⁴⁾	21.02	15.63	18.73																		
	Diluted ⁽⁵⁾	20.55	15.28	18.31																		
	Net asset value per Equity Share																					
	Basic ⁽⁶⁾	170.78	149.36	133.24																		
	Diluted ⁽⁷⁾	166.96	146.02	130.27																		
	<p>1) Total borrowings is calculated as the sum of (i) current borrowings, (ii) non-current borrowings, (iii) current maturities of non-current borrowings and (iv) accrued interest</p> <p>2) EBITDA is calculated as the sum of (i) Profit for the year, (ii) Total tax expenses, (iii) Depreciation and amortisation expense and (iv) Finance costs.</p> <p>3) EPS calculation is in accordance with the Ind AS 33 'Earnings per share' prescribed by the Companies (Indian Accounting Standard) Rules, 2015, as amended</p> <p>4) Basic Earnings per share is calculated as Profit for the year attributable to owners of the company divided by the weighted average number of basic equity shares outstanding during the year. Basic equity shares is calculated as current shares outstanding and shares to be issued upon conversion of Series A CCPS and Series B CCPS</p> <p>5) Diluted Earnings per share is calculated as Profit for the year attributable to owners of the company divided by the weighted average number of diluted equity shares outstanding during the year. Diluted equity shares is calculated as current shares outstanding and shares to be issued upon conversion of Series A CCPS and Series B CCPS and other potentially dilutive instruments</p> <p>6) Basic Net Asset Value per share is calculated as Net worth divided by the weighted average number of basic equity shares outstanding during the year. Basic equity shares is calculated as current shares outstanding and shares to be issued upon conversion of Series A CCPS and Series B CCPS</p> <p>7) Diluted Net Asset Value per share is calculated as Net worth divided by the weighted average number of diluted equity shares outstanding during the year. Diluted equity shares is calculated as current shares outstanding and shares to be issued upon conversion of Series A CCPS and Series B CCPS and other potentially dilutive instruments</p>																					
Auditors' qualifications which have not been given effect to in the Restated Consolidated Financial Information	None																					
Summary table of outstanding litigations	A summary of outstanding litigation proceedings involving our Company and our Subsidiaries, as of the date of this Red Herring Prospectus is provided below. Further, there are no outstanding litigation proceedings against our Promoters, Directors and Group Companies.																					
	<table border="1"> <thead> <tr> <th>Type of Proceedings</th> <th>Number of Cases</th> <th>Amount, to the extent quantifiable (₹ in million)</th> </tr> </thead> <tbody> <tr> <td colspan="3">Litigation against our Company</td> </tr> <tr> <td>Actions by statutory and regulatory authorities</td> <td>6</td> <td>26.06</td> </tr> <tr> <td>Tax matters</td> <td>26</td> <td>198.60</td> </tr> <tr> <td colspan="3">Litigation against our Subsidiaries</td> </tr> <tr> <td>Tax matters</td> <td>2</td> <td>6.90</td> </tr> </tbody> </table>			Type of Proceedings	Number of Cases	Amount, to the extent quantifiable (₹ in million)	Litigation against our Company			Actions by statutory and regulatory authorities	6	26.06	Tax matters	26	198.60	Litigation against our Subsidiaries			Tax matters	2	6.90	
Type of Proceedings	Number of Cases	Amount, to the extent quantifiable (₹ in million)																				
Litigation against our Company																						
Actions by statutory and regulatory authorities	6	26.06																				
Tax matters	26	198.60																				
Litigation against our Subsidiaries																						
Tax matters	2	6.90																				
	For further details, see "Outstanding Litigation and Material Developments" and "Risk Factors" on pages 316 and 22.																					
Risk Factors	For details of the risks applicable to us, see "Risk Factors" on page 22																					
Summary table of contingent liabilities	The following is a summary table of our contingent liabilities as of March 31, 2021:																					
	<table border="1"> <thead> <tr> <th>Contingent Liability</th> <th colspan="2">As at March 31, 2021</th> </tr> </thead> <tbody> <tr> <td>Excise duty, entry tax and service tax matters</td> <td></td> <td>80.35</td> </tr> <tr> <td>Income tax matters</td> <td></td> <td>11.98</td> </tr> </tbody> </table>			Contingent Liability	As at March 31, 2021		Excise duty, entry tax and service tax matters		80.35	Income tax matters		11.98	(₹ in million)									
Contingent Liability	As at March 31, 2021																					
Excise duty, entry tax and service tax matters		80.35																				
Income tax matters		11.98																				
	For further details, see "Financial Statements – Notes to the Restated Consolidated Financial Information – Note 38" on page 258																					
Summary of related party transactions	A summary of related party transactions entered into by our Company with related parties, as per the requirements set out under Ind AS 24 read with the SEBI ICDR Regulations are as follows:																					

	Particulars	Fiscal (₹ in million)		
		2021	2020	2019
	Expenditure towards Corporate Social Responsibility (CSR)			
	Sansera Foundation	20.32	27.50	14.25
	Legal and professional charges			
	Singhvi Dev & Unni	-	-	0.20
	Issue of shares - Subdivision and Bonus issue			
	Client Ebene Limited	-	-	30.69
	CVCIGP II Employee Ebene Limited	-	-	17.19
	Subramonia Sekhar Vasan	-	-	24.62
	Unni Rajagopal	-	-	6.83
	Fatheraj Singhvi	-	-	6.83
	Lalitha Singhvi	-	-	0.10
	Praveen Singhvi	-	-	0.15
	Lata Singhvi	-	-	0.15
	Jayaraj Singhvi	-	-	0.16
	Tara Singhvi	-	-	0.16
	Indira Singhvi	-	-	0.16
	IPO expenses incurred (to be reimbursed by the shareholders)			
	Subramonia Sekhar Vasan	-	0.84	10.40
	Lalitha Singhvi	-	0.02	0.31
	Praveen Singhvi	-	0.04	0.52
	Lata Singhvi	-	0.04	0.52
	Jayaraj Singhvi	-	0.04	0.52
	Tara Singhvi	-	0.04	0.52
	Indira Singhvi	-	0.04	0.52
	Unni Rajagopal	-	0.23	2.89
	Devappa Devaraj	-	0.19	2.32
	Devappa Devaraj on behalf of D. Devaraj HUF	-	0.04	0.57
	Client Ebene Limited	-	3.55	43.63
	CVCIGP II Employee Ebene Limited	-	1.99	24.43
	Managerial Remuneration			
	Subramonia Sekhar Vasan	7.45	14.89	14.89
	Fatheraj Singhvi	7.45	14.73	2.94
	B R Preetham	11.47	13.21	13.83
	S Ramakrishnan	-	-	10.27
	Vikas Goel	11.80	9.54	-
	Sourabh Kumar	-	-	1.96
	Rajesh Kumar Modi	3.46	3.57	0.96
	Muthuswami Lakshminarayan	0.60	1.20	0.90
	Revathy Ashok	0.60	1.20	0.90
	Sylvain Bilaine	0.53	1.20	0.89
	Sitting fees			
	Muthuswami Lakshminarayan	0.11	0.13	0.20
	Revathy Ashok	0.16	0.21	0.21
	Sylvain Bilaine	0.15	0.14	0.10
	Reimbursement of expenses			
	Sylvain Bilaine	-	0.04	0.04
	For further details, see “Other Financial Information – Related Party Transactions” on page 280.			
Details of all financing arrangements whereby the Promoters, members of the Promoter Group, our Directors and their relatives have financed the purchase by any other person of securities of the issuer other than in the normal course of the business of the financing entity during the period of six months immediately preceding the date of the Draft Red Herring Prospectus and this Red Herring Prospectus	There have been no financing arrangements whereby our Promoters, members of the Promoter Group, our Directors and their relatives have financed the purchase by any other person of securities of our Company other than in the normal course of the business of the financing entity during the period of six months immediately preceding the date of the Draft Red Herring Prospectus and this Red Herring Prospectus.			
Weighted average price at which the	Not applicable as none of our Promoters and Investor Selling Shareholders have acquired any Equity Shares in the one year preceding the date of this Red Herring Prospectus.*			

Equity Shares were acquired by our Promoters or Selling Shareholders, in the last one year	<i>*During the one year preceding this Red Herring Prospectus, a) 192,300 Series A CCPS held by Client Ebene Limited and 107,700 Series A CCPS held by CVCIGP II Employee Ebene Limited were converted into 2,845,625 equity shares and 1,594,275 equity shares respectively and b) 480,750 Series B CCPS held by Client Ebene Limited and 269,250 Series B CCPS held by CVCIGP II Employee Ebene Limited were converted into 725 equity shares and 725 equity shares, respectively, and the aforementioned conversion was approved by the board on September 3, 2021.</i>																														
Average cost of acquisition of Equity Shares of our Promoters and selling shareholders	<p>The average cost of acquisition of Equity Shares of our Promoters and Selling Shareholders is as follows:</p> <table border="1"> <thead> <tr> <th>Name</th> <th>Number of Equity Shares held</th> <th>Average cost of acquisition per Equity Share (in ₹) ^{***}</th> </tr> </thead> <tbody> <tr> <td colspan="3">Promoters</td> </tr> <tr> <td>Subramonia Sekhar Vasam</td> <td>12,307,600</td> <td>6.75</td> </tr> <tr> <td>Unni Rajagopal Kothenath</td> <td>3,416,925</td> <td>9.09</td> </tr> <tr> <td>Fatheraj Singhvi *</td> <td>3,366,925*</td> <td>16.97</td> </tr> <tr> <td>Devappa Devaraj</td> <td>2,747,750</td> <td>11.34</td> </tr> <tr> <td colspan="3">Investor Selling Shareholders</td> </tr> <tr> <td></td> <td>Number of Equity Shares held</td> <td>Average cost of acquisition of Equity Shares (₹ per Equity Share)[^]</td> </tr> <tr> <td>Client Ebene Limited</td> <td>18,190,250</td> <td>119.20</td> </tr> <tr> <td>CVCIGP II Employee Ebene Limited</td> <td>10,188,425</td> <td>119.19</td> </tr> </tbody> </table> <p><i>* Fatheraj Singhvi is acting in trust in relation to 2,030,000 Equity Shares held by the Singhvi Family Shareholders</i> <i>** The average cost of acquisition of Equity Shares by the Promoters have been calculated by considering the amount paid to the Company or the transferor to acquire the Equity Shares divided by the total number of Equity Shares acquired.</i> <i>[#]As certified by Manian and Rao, Chartered Accountants, by way of their certificate dated September 6, 2021.</i> <i>[^] The average cost of acquisition of Equity Shares by the Investor Selling Shareholders have been calculated by considering the amount paid to the Company or the transferor to acquire the Equity Shares divided by the total number of Equity Shares acquired.</i></p>	Name	Number of Equity Shares held	Average cost of acquisition per Equity Share (in ₹) ^{***}	Promoters			Subramonia Sekhar Vasam	12,307,600	6.75	Unni Rajagopal Kothenath	3,416,925	9.09	Fatheraj Singhvi *	3,366,925*	16.97	Devappa Devaraj	2,747,750	11.34	Investor Selling Shareholders				Number of Equity Shares held	Average cost of acquisition of Equity Shares (₹ per Equity Share)[^]	Client Ebene Limited	18,190,250	119.20	CVCIGP II Employee Ebene Limited	10,188,425	119.19
Name	Number of Equity Shares held	Average cost of acquisition per Equity Share (in ₹) ^{***}																													
Promoters																															
Subramonia Sekhar Vasam	12,307,600	6.75																													
Unni Rajagopal Kothenath	3,416,925	9.09																													
Fatheraj Singhvi *	3,366,925*	16.97																													
Devappa Devaraj	2,747,750	11.34																													
Investor Selling Shareholders																															
	Number of Equity Shares held	Average cost of acquisition of Equity Shares (₹ per Equity Share)[^]																													
Client Ebene Limited	18,190,250	119.20																													
CVCIGP II Employee Ebene Limited	10,188,425	119.19																													
Size of the pre-IPO placement and allottees, upon completion of the placement	Not applicable.																														
Any issuance of Equity Shares in the last one year for consideration other than cash	Our Company has not issued any Equity Shares for consideration other than cash in the last one year.																														
Any split/consolidation of Equity Shares in the last one year	Our Company has not split or consolidated the face value of the Equity Shares in the last one year.																														

CERTAIN CONVENTIONS, PRESENTATION OF FINANCIAL, INDUSTRY AND MARKET DATA AND CURRENCY OF PRESENTATION

Certain Conventions

All references to “India” in this Red Herring Prospectus are to the Republic of India, all references to “USA”, “US” and “United States” are to the United States of America, all references to “Mauritius” are to the Republic of Mauritius and all references to “Sweden” are to the Kingdom of Sweden.

Unless stated otherwise, all references to page numbers in this Red Herring Prospectus are to the page numbers of this Red Herring Prospectus.

Financial Data

Unless stated otherwise or the context otherwise requires, the financial data in this Red Herring Prospectus is derived from the Restated Consolidated Financial Information.

Our Company’s Financial Year commences on April 1 and ends on March 31 of the next year. Accordingly, all references to a particular Financial Year, unless stated otherwise, are to the 12 month period ended on March 31 of that year.

There are significant differences between Ind AS and U.S. GAAP and IFRS. Our Company does not provide reconciliation of its financial information to IFRS or U.S. GAAP. Our Company has not attempted to explain those differences or quantify their impact on the financial data included in this Red Herring Prospectus and it is urged that you consult your own advisors regarding such differences and their impact on our Company’s financial data. Accordingly, the degree to which the financial information included in this Red Herring Prospectus will provide meaningful information is entirely dependent on the reader’s level of familiarity with Indian accounting principles, policies and practices, the Companies Act and the SEBI ICDR Regulations. Any reliance by persons not familiar with Indian accounting principles, policies and practices on the financial disclosures presented in this Red Herring Prospectus should accordingly be limited.

Unless the context otherwise indicates, any percentage amounts, as set forth in “*Risk Factors*”, “*Our Business*” and “*Management’s Discussion and Analysis of Financial Condition and Results of Operations*” on pages 22, 147 and 282 respectively, and elsewhere in this Red Herring Prospectus have been calculated on the basis of the Restated Consolidated Financial Information.

In this Red Herring Prospectus, any discrepancies in any table between the total and the sums of the amounts listed are due to rounding off. Except as otherwise stated, all figures in decimals have been rounded off to the second decimal and all the percentage figures have been rounded off to two decimal places.

Non-GAAP Financial Measures

We use a variety of financial and operational performance indicators such as Capital Employed, EBIT, EBITDA, EBITDA Margin, PAT Margin, RoCE, RoNW, Net worth, Net Debt, Net Debt to Equity Ratio and Net Asset Value (Basic and Diluted) per share (together, “**Non-GAAP Measures**”) to measure and analyse our operational performance from period to period, and to manage our business. Our management also uses other information that may not be entirely financial in nature, including statistical and other comparative information commonly used within the manufacturing of components for the automotive and aerospace sectors to evaluate our financial and operating performance. The key financial and operational performance indicators and ratios are defined along with a brief explanation in the section, “*Definitions and Abbreviations*” on page 1.

These financial and operational performance indicators have limitations as analytical tools. As a result, these financial and operational performance indicators should not be considered in isolation from, or as a substitute for, analysis of our historical financial performance, as reported and presented in its financial statements.

Further, these financial and operational performance indicators are a supplemental measure of our performance and liquidity that are not required by, or presented in accordance with Ind AS, IFRS or U.S. GAAP, and therefore, should not be viewed as substitutes for performance or profitability measures under Ind AS, IFRS or U.S. GAAP. While these financial and operational performance indicators may be used by other manufacturing companies operating in a similar industry, they may use different financial or performance indicators or calculate these ratios differently, and similarly titled measures published by them may therefore not be comparable to those used by us and should not be considered in isolation or construed as an alternative to cash flows, profit/ (loss) for the year/ period or any other measure of financial performance or as an indicator of our operating performance, liquidity, profitability or cash flows generated by operating, investing or financing activities derived in accordance with Ind AS, Indian GAAP, or IFRS.

Currency and Units of Presentation

All references to:

- “Rupees” or “₹” or “INR” or “Rs.” are to the Indian Rupee, the official currency of India; and

- “USD” or “US\$” or “\$” are to the United States Dollar, the official currency of the United States.

Our Company has presented all numerical information in this Red Herring Prospectus in “million” units or in whole numbers where the numbers have been too small to represent in millions. One million represents 1,000,000 and one billion represents 1,000,000,000.

Figures sourced from third-party industry sources may be expressed in denominations other than millions or may be rounded off to other than two decimal points in the respective sources, and such figures have been expressed in this Red Herring Prospectus in such denominations or rounded-off to such number of decimal points as provided in such respective sources.

Exchange Rates

This Red Herring Prospectus contains conversion of certain other currency amounts into Indian Rupees that have been presented solely to comply with the SEBI ICDR Regulations. These conversions should not be construed as a representation that these currency amounts could have been, or can be converted into Indian Rupees, at any particular rate or at all.

The following table sets forth, for the periods indicated, information with respect to the exchange rate between the Rupee and the respective foreign currencies:

Currency	As at (in ₹)		
	March 31, 2021	March 31, 2020	March 31, 2019 ⁽¹⁾
1 USD	73.51	75.39	69.17
1 EUR	86.09	83.05	77.70

Source: RBI / Financial Benchmark India Private Limited

(1) Exchange rate as on March 29, 2019, as RBI reference rate is not available for March 30, 2019 and March 31, 2019 being a Saturday and a Sunday, respectively.

Industry and Market Data

Unless stated otherwise, industry and market data used throughout this Red Herring Prospectus has been obtained from various industry publications and sources, including the reports titled ‘Assessment of Indian Automotive and Precision Engineering Industry and Potential for Specific Forged and Machined Components’ issued on June 5, 2021 by CRISIL Research, who was appointed by our Company to prepare the report for the purposes of the Offer for an agreed fee pursuant to an engagement letter dated February 9, 2021, and “Global Industry Overview and Market Sizing of Specific Powertrain Components” issued on June 4, 2021 by Ricardo, who was appointed by our Company to prepare the report for the purposes of the Offer for an agreed fee pursuant to an engagement letter dated April 13, 2021.

The CRISIL Report is subject to the following disclaimer:

“CRISIL Research, a division of CRISIL Limited (CRISIL) has taken due care and caution in preparing this report (Report) based on the Information obtained by CRISIL from sources which it considers reliable (Data). However, CRISIL does not guarantee the accuracy, adequacy or completeness of the Data / Report and is not responsible for any errors or omissions or for the results obtained from the use of Data / Report. This Report is not a recommendation to invest / disinvest in any entity covered in the Report and no part of this Report should be construed as an expert advice or investment advice or any form of investment banking within the meaning of any law or regulation. CRISIL especially states that it has no liability whatsoever to the subscribers / users / transmitters/ distributors of this Report. Without limiting the generality of the foregoing, nothing in the Report is to be construed as CRISIL providing or intending to provide any services in jurisdictions where CRISIL does not have the necessary permission and/or registration to carry out its business activities in this regard. _Sansera Engineering_ Limited will be responsible for ensuring compliances and consequences of non-compliances for use of the Report or part thereof outside India. CRISIL Research operates independently of, and does not have access to information obtained by CRISIL Ratings Limited / CRISIL Risk and Infrastructure Solutions Ltd (CRIS), which may, in their regular operations, obtain information of a confidential nature. The views expressed in this Report are that of CRISIL Research and not of CRISIL Ratings Limited / CRIS. No part of this Report may be published/reproduced in any form without CRISIL’s prior written approval.”

The Ricardo Report is subject to the following disclaimer:

“This report was commissioned by Sansera Engineering Limited (the “Company”) on terms specifically limiting Ricardo’s liability (the “Report”). Our conclusions are the results of the exercise of our best professional judgment based upon Ricardo internal analysis and relevant market analysis. The Report may be shared by the Company with the book running lead managers and legal counsel in relation to the proposed initial public offering of the Company.

Any use which a third party, other than the book running lead managers, makes of this document, or any reliance on it, or decisions to be made based on it, are the responsibility of such third party. Ricardo UK Limited accepts no duty of care or liability of any kind whatsoever to any such third party, and no responsibility for damages, if any, suffered by any third party as a result of decisions made, or not made, or actions taken, or not taken, based on the Report.

In preparing this Report Ricardo may have relied on data, information or statements supplied to us by third parties or available on public sources on or prior to Report’s date (the “Data”), in which case we have not independently verified the Data unless expressly

stated in the Report, and such Data has been sourced from third parties that Ricardo considers reliable. The Data is assumed to be accurate, complete, reliable and current as of the date of such information and no responsibility for any error or omission in the Report arising from errors or omissions in such Data is accepted. No representation or warranty, express or implied, is or will be made in relation to the accuracy or completeness of the Data and no responsibility or liability is or will be accepted by Ricardo in relation to the Data.

Any forecasts presented in the Report were prepared using Data and the Report is dependent on it. Some of the assumptions used to develop any forecasts may not be realised and unanticipated events and circumstances may occur. Consequently, Ricardo does not warrant the conclusions contained in the Report as there may be material differences between forecasts and actual results. While Ricardo has taken due care and caution in preparing the Report, Ricardo shall not be responsible for any errors or omissions in or for the results obtained from the use of or the decisions made based on, the Report.”

For risks in this regard, see “*Risk Factors – Statistical and industry data in this Red Herring Prospectus are derived from the CRISIL Report and the Ricardo Report, both of which were commissioned by our Company for the purpose of the Offer for an agreed fee. Each of the CRISIL Report and the Ricardo Report is not exhaustive and is based on certain assumptions, parameters and conditions. The data and statistics in the CRISIL Report and the Ricardo Report may be inaccurate, incomplete or unreliable*” on page 52.

Industry publications generally state that the information contained in such publications has been obtained from publicly available documents from various sources believed to be reliable but their accuracy and completeness are not guaranteed and their reliability cannot be assured. Accordingly, no investment decisions should be based on such information. The data used in these sources may have been re-classified by us for the purposes of presentation. Data from these sources may also not be comparable.

The extent to which the market and industry data used in this Red Herring Prospectus is meaningful depends on the reader’s familiarity with and understanding of the methodologies used in compiling such data. There are no standard data gathering methodologies in the industry in which the business of our Company is conducted, and methodologies and assumptions may vary widely among different industry sources.

Accordingly, no investment decision should be made solely on the basis of such information. Such data involves risks, uncertainties and numerous assumptions and is subject to change based on various factors, including those disclosed in “*Risk Factors*” on page 22.

In accordance with the SEBI ICDR Regulations, the section “*Basis for Offer Price*” on page 86 includes information relating to our listed industry peers. Such information has been derived from publicly available sources, and neither we, nor the BRLMs or the Selling Shareholders have independently verified such information.

FORWARD-LOOKING STATEMENTS

This Red Herring Prospectus contains certain “forward-looking statements”. All statements contained in this Red Herring Prospectus that are not statements of historical fact constitute “forward-looking statements”. All statements regarding our expected financial condition and results of operations, business, plans and prospects are forward-looking statements. These forward-looking statements generally can be identified by words or phrases such as “aim”, “anticipate”, “believe”, “expect”, “estimate”, “intend”, “likely to”, “seek to”, “shall”, “objective”, “plan”, “project”, “will”, “will continue”, “will pursue” or other words or phrases of similar import. Similarly, statements that describe our strategies, objectives, plans or goals are also forward-looking statements. All forward-looking statements whether made by us in this Red Herring Prospectus are based on our current plans, estimates, presumptions and expectations and are subject to corresponding risks, uncertainties and assumptions about us that could cause actual results to differ materially from those contemplated by the relevant forward-looking statement, including but not limited to, regulatory changes pertaining to the industries we serve and our ability to respond to them, our ability to successfully implement our strategy, our growth and expansion, technological changes, our exposure to market risks, general economic and political conditions which have an impact on our business activities or investments, the monetary and fiscal policies of India, inflation, deflation, unanticipated turbulence in interest rates, foreign exchange rates, equity prices or other rates or prices, the performance of the financial markets in India and globally, changes in domestic laws, regulations and taxes and changes in competition. Important factors that could cause actual results to differ materially from our expectations include, but are not limited to, the following:

- Continuing impact of COVID-19 pandemic;
- Lack of firm commitment long-term supply agreements with our customers;
- Dependence on the sale of our products to certain key customers;
- Pricing pressure from our customers;
- Seasonal or economic cyclicality coupled with reduced demand in the verticals and sectors in which we operate;
- Development of technologically advanced products involves a lengthy and expensive process with uncertain timelines and outcomes;
- Failure to adapt to industry trends and evolving technologies;
- Decline in the financial condition of our customer; and
- Loss of members of our senior management team and other personnel with technical expertise.

For further discussion of factors that could cause the actual results to differ from the expectations, see “*Risk Factors*”, “*Our Business*” and “*Management’s Discussion and Analysis of Financial Condition and Results of Operations*” on pages 22, 147 and 282, respectively. By their nature, certain market risk disclosures are only estimates and could be materially different from what actually occurs in the future. As a result, actual future gains or losses could materially differ from those that have been estimated and are not a guarantee of future performance.

Forward-looking statements reflect our current views as of the date of this Red Herring Prospectus and are not a guarantee of our future performance. There can be no assurance to investors that the expectations reflected in these forward-looking statements will prove to be correct. Given these uncertainties, investors are cautioned not to place undue reliance on such forward-looking statements and not to regard such statements to be a guarantee of our future performance.

These statements are based on our management’s belief and assumptions, which in turn are based on currently available information. Although we believe the assumptions upon which these forward looking statements are based on are reasonable, any of these assumptions could prove to be inaccurate and the forward looking statements based on these assumptions could be incorrect. Given these uncertainties, investors are cautioned not to place undue reliance on such forward-looking statements and not to regard such statements as a guarantee of future performance. Neither our Company, the Selling Shareholders, our Promoters, our Directors, the BRLMs nor any of their respective affiliates have any obligation to update or otherwise revise any statements reflecting circumstances arising after the date hereof or to reflect the occurrence of underlying events, even if the underlying assumptions do not come to fruition. In accordance with the requirements of SEBI, our Company shall, ensure that investors in India are informed of material developments from the date of this Red Herring Prospectus until the date of Allotment. In accordance with requirements of SEBI, each of the Selling Shareholders, severally and not jointly, shall ensure that the Company and the BRLMs are informed of material developments, in relation to statements and undertakings specifically undertaken or confirmed by the Selling Shareholders in relation to themselves and the respective portion of the Offered Shares offered by each of the Selling Shareholders from the date of this Red Herring Prospectus until the Allotment. Only statements and undertakings which are specifically confirmed or undertaken by the Selling Shareholders, as the case may be, in this Red Herring Prospectus shall be deemed to be statements and undertakings made by the Selling Shareholders.

SECTION II: RISK FACTORS

An investment in the Equity Shares involves a certain degree of risk. You should carefully consider all the information in this Red Herring Prospectus, including the risks and uncertainties described below, before making an investment in the Equity Shares. This section should be read in conjunction with “Industry Overview”, “Our Business”, “Financial Statements”, and “Management’s Discussion and Analysis of Financial Condition and Results of Operations” on pages 94, 147, 219 and 282, respectively, before making an investment decision in relation to the Equity Shares.

The risks described below are not the only ones relevant to us or the Equity Shares or the industry in which we operate. Additional risks and uncertainties not presently known to us or that we currently deem immaterial may also impair our businesses, results of operations, financial condition and cash flows. If any of the following risks or other risks that are not currently known or are currently deemed immaterial actually occur, our businesses, results of operations, financial condition and cash flows could suffer, the trading price of the Equity Shares could decline, and investors may lose all or part of their investment. The financial and other related implications of risks concerned, wherever quantifiable, have been disclosed in the risk factors described below. However, there are certain risk factors where such implications are not quantifiable, and hence any quantification of the underlying risks has not been disclosed in such risk factors. To the extent the COVID-19 pandemic adversely affects our business and financial results, it may also have the effect of heightening many of the other risks described in this section.

In making an investment decision, prospective investors must rely on their own examination of our Company and the terms of the Offer including the merits and risks involved. Prospective investors should consult their tax, financial and legal advisors about the particular consequences to them of an investment in the Equity Shares.

This section contains forward-looking statements that involve risks, assumptions, estimates and uncertainties. Our actual results could differ materially from those anticipated in these forward-looking statements as a result of certain factors, including the considerations described below and elsewhere in this Red Herring Prospectus. For further details, see “Forward-Looking Statements” on page 21.

Our fiscal year commences on April 1 and ends on March 31 of the subsequent year, and references to a particular Fiscal are to the 12 months ended March 31 of that year. Unless otherwise indicated or the context otherwise requires, the financial information included herein is derived from the Restated Consolidated Financial Information, which are in “Financial Statements” on page 219.

Industry and market data used in this section have been derived from the CRISIL Report and the Ricardo Report, both of which were commissioned by our Company for the purpose of the Offer for an agreed fee. For more details, see “Certain Conventions, Presentation of Financial, Industry and Market Data and Currency of Presentation – Industry and Market Data” on page 19.

INTERNAL RISK FACTORS

1. ***The COVID-19 pandemic has had, and we expect it to continue to have, a material adverse effect on our business, financial condition, results of operations and cash flows.***

Fiscal 2021 was volatile for the global economy and the resurgence of COVID-19 cases in some countries has prompted authorities to re-impose lockdowns to contain the spread of the virus. The International Monetary Fund (IMF) has raised a few lingering concerns: surging infections for new variants of the virus and renewed lockdowns, logistical problems with vaccine distribution and uncertainty about vaccine uptake. High-frequency data from some economies suggest that the pace of economic recovery has slowed down in the fourth quarter of CY 2020. Even with anticipated recovery, IMF does not expect output gaps to close until after CY 2022. CRISIL Research estimates that India’s GDP will contract by 7.3% in Fiscal 2021. (Source: the CRISIL Report, page 7).

Shortly after the World Health Organization (WHO) declared the outbreak of COVID-19 a global pandemic on March 11, 2020, the Government of India implemented a nation-wide lockdown on March 23, 2020 (which was extended to May 31, 2020) and we temporarily suspended operations in all our manufacturing facilities and advised our employees in India to work from home to the extent they could in compliance with the lockdown instructions issued by the central and state governments of India. COVID-19 has impacted our normal business operations by interrupting our production and supply chain. In addition, the spread of COVID-19 caused us to implement significant proactive measures to protect the health and safety of our employees. The table below sets forth the periods during which our manufacturing facilities were shut down due to the first wave of the COVID-19 pandemic.

Name of manufacturing facility	Period of shutdown (inclusive) / Days of shutdown ⁽¹⁾
Plant 1, Plant 2, Plant 3, Plant 7, Plant 10, Plant 11, Plant 12 and Plant 14 ⁽²⁾	March 23, 2020 to May 3, 2020 / 34 days
Plant 4	March 23, 2020 to May 5, 2020 / 38 days
Plant 5	March 23, 2020 to May 5, 2020 / 36 days
Plant 6	March 23, 2020 to April 20, 2020 / 25 days
Plant 9	March 23, 2020 to April 7, 2020 / 14 days

Name of manufacturing facility	Period of shutdown (inclusive) / Days of shutdown ⁽¹⁾
Plant 15	March 23, 2020 to June 30, 2020 / 85 days
Fitwel Plant 1 and Fitwel Plant 2	March 23, 2020 to May 3, 2020 / 34 days

Notes:

(1) The number of days a plant was shut down for does not include Sundays and declared holidays.

(2) Plant 8 was also shut down but it is used for training, quality systems and new product development and not for manufacturing.

The temporary suspension of operations at our manufacturing facilities in India had a material adverse effect on our results of operations, financial condition and cash flows as at and for the Fiscal years ended March 31, 2021 and 2020. During the period, our manufacturing facilities were shut down and we experienced overall low demand, which resulted in fewer orders for our products. Although the nation-wide lockdown was lifted on June 1, 2020, production in our manufacturing facilities continued to be adversely affected due to the unavailability of some of our workforce, supply chain disruption and issues around timely availability and transportation of raw materials. Our overall capacity utilisation at our manufacturing facilities returned to pre-COVID-19 levels in July 2020.

India seemed to have gotten COVID-19 cases under control, with the number of cases declining post September 2020. However, since the end of February 2021, India has been witnessing a second wave of COVID-19 cases with a surge in infection cases, leading to state governments taking steps to control the spread including imposing curfews and lockdowns, resulting in loss of economic output. (Source: the CRISIL Report, page 8). This resulted in the temporary suspension of operations or reduced capacity at certain of our manufacturing facilities in India. The table below sets forth the periods during which our manufacturing facilities were shut down or operated with reduced capacity due to the second wave of the COVID-19 pandemic.

Name of manufacturing facility	Period of shutdown (inclusive) / Days of shutdown ⁽¹⁾	Period of reduced capacity utilisation / Days of reduced capacity utilisation ⁽¹⁾
Plant 1, Plant 2, Plant 3, Plant 7, Plant 8 ⁽²⁾ , Plant 10, Plant 12 and Plant 14	May 10, 2021 to May 11, 2021 / 2 days	Subsequently allowed to operate with only 50% workforce from May 12 to June 6, 2021 / 22 days
Plant 4	May 1, 2021 / 1 day	Not applicable
Plant 11	May 10, 2021 to May 13, 2021 / 4 days	Subsequently allowed to operate with only 50% workforce from May 14 to June 6, 2021 / 20 days
Plant 15	May 1, 2021 to May 14, 2021 / 12 days	Not applicable
Fitwel Plant 1 and Fitwel Plant 2	May 10, 2021 to May 12, 2021 / 3 days	Subsequently allowed to operate with only 50% workforce from May 13 to June 6, 2021 / 21 days

Notes:

(1) The number of days a plant was shut down for or had or will have reduced capacity does not include Sundays and declared holidays.

(2) Plant 8 was also shut down and subject to the same 50% workforce capacity cap but it is used for training, quality systems and new product development and not for manufacturing.

The above shutdowns and reductions in capacity utilisation will have an adverse effect on our financial condition results of operations and cash flows as at and for the year ended March 31, 2022 and any interim period therein beginning in April 2021.

During the second wave of COVID-19 cases, the number of total daily active cases had crossed the 400,000 mark for the first time in the first week of May. During the first week of June, the number of daily active cases had dropped sharply to under 140,000. The growth outlook for Fiscal 2022 will see a downward pressure if India faces a severe third wave of COVID-19 cases during Fiscal 2022. In case the spread of COVID-19 increases dramatically like in the second wave and the concerned authorities put in place more stringent measures to control the same, it can have a debilitating impact on economic activity and thereby growth going forward. Availability of vaccines and the pace of vaccinations will be key monitorable issues. Any unavailability of vaccines is likely to hinder and delay economic recovery. (Source: the CRISIL Report, page 8).

The extent to which the COVID-19 pandemic and the related economic crisis continue to adversely affect our business, results of operations, financial condition and cash flows will depend on future developments that cannot be entirely predicted, including the duration and spread of the pandemic, additional actions that may be taken by government authorities, the further effect on our customers, suppliers and business partners, our ability to continue to manufacture and sell our products, ability of our customers to pay in a timely manner, any closures of our facilities and the facilities of our customers and suppliers and demand for our products. In addition, there can be no assurance that any efforts taken by us to address the adverse impacts of the COVID-19 pandemic or actions taken to contain the COVID-19 pandemic or its impact will be effective or will not result in significant additional costs.

Given that there are significant fixed costs associated with our business, it may be difficult to adjust our cost base to withstand a complete and prolonged lockdown situation as a result of COVID-19. As a result, our financial condition,

results of operations and cash flows may be adversely affected during periods of prolonged lockdown, which may result in declining production and sales volumes. If our cash flow from operations is adversely affected, we may be required to rely on the banking and credit markets to meet our financial commitments and short-term liquidity needs. However, we cannot guarantee that this funding will be available on commercially reasonable terms or at all.

Further, it could adversely impact our ability to service our debt obligations, comply with the covenants in our financing agreements and could result in events of default and the acceleration of indebtedness; Fitwel, our Company's subsidiary, availed the moratorium granted by the RBI on account of disruptions due to COVID-19 for a period of two months (i.e., May to June 2020) and six months (i.e., March to August 2020) from two lenders, aggregating to a deferment of payment of ₹ 3.78 million and ₹ 12.61 million, respectively. For more information, see "*History and Certain Corporate Matters – Defaults or re-scheduling, restructuring of borrowings with financial institutions/banks*" on page 192.

For more information on the effects of COVID-19 and the lockdown and restrictions on our business, financial condition, results of operations and cash flows as at and for the fiscal years ended March 31, 2021 and 2020, see "*Management's Discussion and Analysis of Financial Condition and Results of Operations – Significant Factors Affecting our Results of Operation and Financial Condition – Effects of COVID-19*" on page 283.

2. *We do not have firm commitment long-term supply agreements with our customers. If our customers choose not to source their requirements from us, there may be a material adverse effect on our business and results of operations.*

We do not generally have firm commitment long-term supply agreements with our customers and instead rely on purchase orders issued by our customers from time to time that set out the commercial terms, delivery conditions and the indicative volumes to be procured from us. Where we have supply agreements with our customers, these agreements set forth the terms of sales but do not bind customers to any specific products, specifications, purchase volumes or duration and can be terminated by our customers with or without cause, with little or no advance notice and without compensation. In addition, such supply agreements provide flexibility to our customers to place an order for a lesser quantity of products in the schedules given to us despite a higher quantity specified in the contract. Customers may also place an order for products with different specifications from those stated in the contract. There is no commitment on the part of the customer to continue to place orders with us. For actual supply, we rely on schedules given to us periodically by our customers. These schedules may be amended or cancelled prior to delivery, and should such amendment or cancellation take place, we may be unable to seek compensation for any surplus products that we manufacture that are unpurchased. As our customers do not typically give these schedules to us until a short time before the products are required from us, we do not hold a significant order book at any time, making it difficult for us to forecast revenue, production volume or sales.

In addition, some of the master supply agreements that we have entered into with our customers are governed by foreign laws and are subject to foreign jurisdiction, which may create practical difficulties for us to enforce our rights under these agreements, as we may be unfamiliar with the foreign laws and we may not have a presence in the foreign jurisdictions.

Further, substantially all of our products are customised to specific customer requirements, and we incur significant costs in setting up our capabilities to manufacture these products, which may not be fully recovered from sales of products to our customers in case they reduce sourcing from us. Even though most of our equipment, machinery and production lines are fungible, there would be a time delay in redeploying the equipment, machinery and production lines for use in manufacturing different products, which could adversely affect our results of operations and cash flows. For further details, see "*Our Business – Our Strengths – Advanced capabilities in design and engineering, machine building and automation resulting in continuous new product development and improved productivity, with fungibility of equipment, machinery and production lines across product families and sectors*" on page 151.

Our customers have high standards for product quality and delivery schedules. Any failure to meet customers' expectations could result in the cancellation or non-renewal of our supply agreements with them. Also, purchase orders are typically subject to conditions such as ensuring that all products delivered to the customer have been inspected and are safe for use. Customers may set off any payment obligations, require indemnification for themselves or their affiliates, change their outsourcing strategy by undertaking more work in-house or replace their existing products with alternative products, any of which may have an adverse effect on our business and results of operations.

3. *Our business is dependent on the sale of our products to certain key customers. The loss of any of these customers or loss of revenue from sales to these customers could have a material adverse effect on our business, financial condition, results of operations and cash flows.*

We are dependent on certain key customers, especially Bajaj, in the automotive sector. For Fiscals 2021, 2020 and 2019, Bajaj contributed 20.75%, 22.08% and 22.71% of our revenue from sale of products, respectively, and our top five customers contributed 59.21%, 59.46% and 60.01% of our revenue from sale of products, respectively. The loss of these customers or a loss of revenue from sales to these customers may materially affect our business, financial condition, results of operations and cash flows. Further, as it is common for large OEMs to source their required components from

a relatively small number of vendors, our customers often undertake vendor rationalisation to reduce costs related to procurement from multiple vendors. As a result, the volume of sales to our customers may vary due to changes in our customers sourcing strategies. We cannot assure you that we will be able to significantly reduce customer concentration in the future.

We do not have firm long-term purchase agreements with our key customers. We generally supply our products for particular models of vehicles and the discontinuation of, loss of business with respect to, or lack of commercial success of, those particular models of which we are a major supplier of components could reduce our sales and have a material adverse effect on our business, financial condition, results of operations and cash flows. As we are dependent on certain key customers for a significant portion of our sales, the loss of any one of our key customers, if not replaced, may have a material adverse effect on our business, results of operations and financial condition.

4. *Pricing pressure from our customers may adversely affect our gross margin, profitability and ability to increase our prices, which may in turn have a material adverse effect on our results of operations and financial condition.*

We manufacture and supply complex, high-quality precision forged and machined components for the automotive and non-automotive sectors, primarily supplying to OEMs in India and internationally. OEMs in the precision components industry generally pursue aggressive but systematic price reduction initiatives and objectives each year with their suppliers. We have in the past experienced and may continue to experience pressure from our customers to reduce our prices, which may affect our profit margins going forward. In addition, as any price reduction is the result of negotiations and factors that may be beyond our control, we, like other manufacturers, must be able to reduce operating costs and increase operating efficiencies in order to maintain profitability. As our business is very capital intensive, requiring us to maintain a large, fixed cost base, our profitability is dependent, in part, on our ability to spread fixed costs over higher sales volume. However, we may not be able to spread such fixed costs effectively as our customers generally negotiate for larger discounts in price as the volume of their orders increases. If we are unable to offset customer price reductions in the future through improved operating efficiencies, new manufacturing processes, sourcing alternatives and other cost reduction initiatives, our results of operations and financial condition may be materially adversely affected.

5. *Development of technologically advanced products involves a lengthy and expensive process with uncertain timelines and outcomes. We may be unsuccessful in innovating or developing technologically advanced products or may be unable to add to our existing capabilities, which could adversely affect our business, results of operations and cash flows.*

Our future growth depends on our ability to continue to develop and commercialize innovative, viable and sustainable new automotive systems and components in a timely and cost-effective manner. The development and commercialization of new products is complex, time-consuming and costly, and its outcome is inherently uncertain. The automotive industry is characterized by rapid and frequent advancements in technology and changes in market demand can often render existing technologies and equipment obsolete and could require substantial new capital expenditures or subject us to write-offs. Due to the long lead times associated with development for many of the technologically advanced automotive systems and components, as well as the competitive advantage that can come from being the initial developer of a new product, it is important that we maintain a sufficiently large portfolio of systems and components and a product pipeline and manage their development processes so as to bring our systems and components to market on a timely basis. The launch of a new product is a complex process, the success of which depends on a wide range of factors, including the production readiness of our manufacturing facilities and manufacturing processes and those of our suppliers, as well as factors related to tooling, equipment, employees, initial product quality and other factors. Production shortfalls or production delays, if any, or our inability to accurately estimate the cost to design, develop and launch new products could result in our failure to effectively manage our manufacturing costs relating to these product program launches. If we are unable to bring enough products to market, or if products are brought to market after competing products are commercialized, our growth strategy may not be successful, and our business would be adversely affected.

We are dependent on the success of our design and engineering team and the failure to develop new or improved products or process improvements or production techniques could subject us to write-offs or otherwise adversely affect our business, financial condition and results of operations and have a negative effect on our competitive position. As of July 31, 2021, a team of 201 personnel supported our design, engineering, machine building, automation and technical support functions. During Fiscals 2021, 2020 and 2019, our total expenditure on manpower who were with us at the end of each fiscal year on engineering activities, including designing, manufacturing, machine building and technical support amounted to ₹ 72.30 million, ₹ 73.27 million and ₹ 55.87 million, respectively, representing 0.47%, 0.50% and 0.34%, respectively, of our total revenue from operations. We cannot assure you that the investments we have made in our engineering division will yield satisfactory results, if any, in terms of improved products. Despite our investments in this area, our engineering efforts may not result in the discovery or successful development of new and innovative systems and components.

One of our strategies is to introduce new products in order to diversify, de-risk and grow our revenues. For details, see “Our Business – Our Strategies – Consolidate and strengthen global market share in our existing automotive product portfolio and diversify into new products to cater to the expected increase in electrification of vehicles”, “Our Business

– *Our Strategies – Continue to leverage our existing capabilities to diversify further into non-automotive businesses and expand addressable market*” and “*Our Business – Products Recently Developed / Under Development*” on pages 154, 156 and 164, respectively. For a table showing the revenue from the sale of new product families introduced in Fiscals 2021, 2020 and 2019 and such revenue from sale of products as a percentage of our total revenue from sale of products, see “*Management’s Discussion and Analysis of Financial Condition and Results of Operations – Significant Factors Affecting our Results of Operations and Financial Condition – Introduction of New Product Families and Acquisition of New Customers*” on page 288. We cannot guarantee that the new products we introduce will be successful or will continue to be successful, whether due to factors within or outside of our control, such as general economic conditions and failure to predict customer demand or understand market requirements. In the event that such products are unsuccessful, we may lose any or all of the investments that we have made in developing them, which could have an adverse effect on our business, financial condition, results of operations and cash flows.

In addition, even where we successfully develop any such new or improved products in a timely manner, there can be no assurance that the new or improved product will be commercially successful and meet the price expectations of our customers. Further, if our competitors develop new processes or production techniques, or improve existing processes or production techniques that may give them significant cost and marketing advantages, we may be unable to retain our customers, which would adversely affect our revenues and profitability. We also cannot guarantee that any investment we make in developing products will be recouped, even if we are successful in commercializing those products.

6. *Any failure to adapt to industry trends and evolving technologies to meet our customers’ demands may materially adversely affect our business and results of operations.*

Changes in consumers’ preferences, regulatory or industry requirements, or competitive technologies may render certain of our products obsolete or less attractive. For instance, our key products, such as connecting rods and crankshafts, are not used in battery electric vehicles, and our ability to anticipate and successfully develop and introduce new or enhanced products on a timely basis is a significant factor in our ability to remain competitive.

Consumer preferences, especially in many developed markets, appear to be moving in favour of more fuel efficient and environmentally friendly vehicles. In addition, increased government regulations and volatile fuel prices have brought significant pressure on the automotive industry to reduce carbon dioxide emissions. Further, we may not have the ability to adequately respond to market trends, such as the penetration of battery electric vehicles in India and internationally. Ricardo forecasts battery electric vehicle penetration in the global Light Vehicle segment and commercial vehicle segment will reach 12.2% and 4.0%, respectively, by CY 2025. (Source: *the Ricardo Report, pages 8 and 18*). Within the Indian market, CRISIL Research forecasts that by Fiscal 2026, in terms of sales, electric vehicle penetration in passenger vehicles will be approximately 4% and electric vehicle penetration in two-wheelers in India will be 8.2%. (Source: *the CRISIL Report, page 114*). For more details, see “*Industry Overview*” on page 94.

There can be no assurance that we will be able to secure the necessary technological knowledge to enable us to develop our product portfolio as planned. For instance, we may not be able to install and commission the facilities required to manufacture new products for our customers in time for the start of production, and the transitioning of our manufacturing facilities and resources to full production for new products may impact production rates or other operational efficiency measures at our facilities. Any failure on our part to successfully adopt such technologies in a cost effective and a timely manner may increase our costs and lead to us being less competitive.

We could also face competition for potential future revenue streams if our competitors are able to commercialise certain innovations before we can do so. We may have to procure a license for the technology, which may not be available on reasonable terms, if at all, and may significantly increase our operating expenses or may require us to restrict our business activities in one or more respects. As a result, we may also be required to develop alternative non-infringing technology, which could require significant effort and expense. If we fail to develop sufficient revenue streams covered by adequately robust intellectual property rights, we could lose market share and revenues to competitors. Any of these developments, alone or in combination, may have a material adverse effect on our business, results of operations and financial condition.

7. *We derive a substantial portion of our revenue from our key product families, especially connecting rods, and if these products become obsolete it would have a material adverse effect on our business, financial condition, results of operations and cash flows.*

We derive a substantial portion of our revenue from our key product families, especially connecting rods. For details of our revenues generated from the sale of these key product families, see “*Our Business-Our Strengths-Well diversified business model*” on page 149.

We are one of the top 10 global suppliers of connecting rods within the Light Vehicle segment and one of top 10 global suppliers of connecting rods within the commercial vehicle segment for CY 2020. (Source: *the Ricardo Report, pages 42 and 43*). We have been gaining market share in connecting rods in terms of production volume (units) for (i) Light Vehicles with a global market share of 2.3% in CY 2020 compared to a global market share of 0.9% in CY 2015 and (ii) CVs with a global market share of 3.0% in CY 2020 compared to a global market share of 0.9% in CY 2015. (Source:

the Ricardo Report, pages 32 and 33). For details of the other top 10 global suppliers of connecting rods within the Light Vehicle segment and their market share and the other top 10 global suppliers of connecting rods within the commercial vehicle segment and their market share for CY 2020, see “*Industry Overview-Market Sizing and Outlook of Relevant Auto Component Segments – Connecting Rods-Connecting Rod Market Size in Light Vehicle Segment (Global) – Supplier Market Share in Light Vehicle Segment*” and “*Industry Overview-Market Sizing and Outlook of Relevant Auto Component Segments – Connecting Rods-Connecting Rod Market Size in Commercial Vehicle Segment (Global) – Supplier Market Share in Commercial Vehicle Segment*” on pages 133 and 135, respectively.

We are one of the leading Indian manufacturers of (i) connecting rods, crankshafts, rocker arms and gear shifter forks for two-wheelers and (ii) connecting rods and rocker arms for passenger vehicles. Specifically, we are the largest supplier of connecting rods, rocker arms and gear shifter forks to two-wheeler OEMs in India. We are the largest supplier of connecting rods and rocker arms to passenger vehicle OEMs in India. (Source: *the CRISIL Report, pages 191, 194, 198 and 201*). For details of the other key players in these product categories in India, see “*Industry Overview – Market Sizing and Outlook of Relevant Auto Component Segments – Connecting Rods – Connecting rod market for various vehicle categories in India – Key Players*”, “*Industry Overview – Market Sizing and Outlook of Relevant Auto Component Segments – Crankshafts – Two-wheeler and passenger vehicle crankshaft market in India – Key Players*”, “*Industry Overview – Market Sizing and Outlook of Relevant Auto Component Segments – Rocker Arms – Two-wheeler and passenger vehicle rocker arms market in India – Key Players*” and “*Industry Overview – Market Sizing and Outlook of Relevant Auto Component Segments – Gear shifter forks – Market for two-wheeler and passenger vehicle gear shifter forks in India – Key Players*” on pages 131, 137, 139 and 140, respectively.

Given our leadership position in connecting rods and the fact that connecting rods have multiple end use applications across both automotive (two-wheelers, passenger vehicles, and commercial vehicles) as well as certain non-automotive sectors (off-road, agriculture and other segments, including engineering and capital goods), we expect connecting rods to continue to account for a large percentage of our revenue in the near term. Continued market acceptance of these products is therefore critical to our future success.

Our future success will also depend in part on our ability to reduce our dependence on these products by developing and introducing new products and product or feature enhancements in a timely manner. For more details, see “- *We may not be successful in implementing our growth strategies, such as developing multiple technology driven systems and components to cater to growing opportunities in electrification of vehicles and extending our existing capabilities to engineer additional precision components for non-automotive applications, which could have a material adverse effect on our business, financial condition, results of operations and cash flows*” on page 29. We have an active product development pipeline to continue supporting future growth. For details, see “*Our Business-Products Recently Developed / Under Development*” on page 164. However, there can be no assurance that any products we develop and introduce will achieve market acceptance. Any failure to successfully develop, launch and market new products could adversely affect our business and results of operations.

8. *We depend on our senior management team and other personnel with technical expertise, and if we are unable to recruit and retain qualified and skilled personnel, our business and our ability to operate or grow our business may be adversely affected.*

Our success depends to a large extent on the continued services of our senior management team and other personnel with technical expertise. In an event they no longer work for us, there is no assurance that we will be able to find suitable replacements for such Key Managerial Personnel in a timely manner or at all and implement a smooth transition of responsibilities to any newly appointed management personnel. The market for qualified professionals is competitive and we may not continue to be successful in our efforts to attract and retain qualified people. We may therefore need to increase compensation and other benefits in order to attract and retain personnel in the future, which may adversely affect our results of operations. The attrition of our Key Managerial Personnel was nil out of average number of eight Key Managerial Personnel in Fiscal 2021, nil out of average number of eight Key Managerial Personnel in Fiscal 2020 and one out of average number of eight Key Managerial Personnel, or 12.90%, in Fiscal 2019. The attrition of all of our staff (managerial staff, engineers, executives, trainee engineers and assistants) and confirmed employees was 175 out of an average number of 2,114 employees, or 8.28%, in Fiscal 2021, 176 out of an average number of 2,110 employees, or 8.34%, in Fiscal 2020 and 181 out of an average number of 2,059 employees, or 8.79%, in Fiscal 2019. The attrition of trainees and apprentices was 1,404 out of average number of 1,281 trainees and apprentices, or 109.59%, in Fiscal 2021, 732 out of average number of 1,502 trainees and apprentices or 48.72%, in Fiscal 2020 and 824 out of average number of 1,713 trainees and apprentices, or 48.10%, in Fiscal 2019. Trainees and apprentices are employed for a fixed tenure and there is a regular churn. Driven primarily by the higher churn in trainees and apprentices, the attrition of all of our employees (staff, confirmed employees, and trainees and apprentices) was 1,579 out of an average number of employees of 3,395, or 46.51%, in Fiscal 2021, 908 out of an average number of 3,613 employees, or 25.13%, in Fiscal 2020 and 1,005 out of an average number of employees of 3,772, or 26.64%, in Fiscal 2019. The attrition was calculated as the number of employees who left during the fiscal year divided by the monthly average closing headcount during the fiscal year. We are a technology driven company with significant focus and investment in our in-house engineering capabilities. Our future success, amongst other factors, will depend upon our ability to continue to attract and retain qualified personnel, particularly engineers and other associates with critical expertise, know-how and skills that are

capable of helping us develop technologically advanced systems and components and support key customers and products. The specialised skills we require in our industry are difficult and time-consuming to acquire and, as a result, are in short supply. We require a long period of time to hire and train replacement personnel when we lose skilled employees. Our inability to hire, train and retain a sufficient number of qualified employees could delay our ability to bring new products or services to the market and impair the success of our operations. This could have an adverse effect on our business and results of operations.

Our success also depends, in part, on key customer relationships forged by our senior management team. If we were to lose these members of the senior management, we cannot assure you that we will be able to continue to maintain key customer relationships or renew them, which could adversely affect our business, financial condition, results of operations and cash flows.

9. *Our employees are members of unions and we may be subject to industrial unrest, slowdowns and increased wage costs, which may adversely affect our business and results of operations.*

We operate manufacturing facilities in numerous locations in India as well as in Sweden that have stringent labour legislation in place that protects the interests of workers, including legislation that sets forth detailed procedures for the establishment of unions, dispute resolution and employee removal, and legislation that imposes certain financial obligations on employers upon retrenchment.

As of July 31, 2021, 1,174 of our employees were members of labour unions. Accordingly, it may be difficult for us to maintain flexible labour policies and we may face the threat of labour unrest, work stoppages and diversion of our management's attention due to union intervention. Labour unrest or work stoppages or other slowdown at one or more of our manufacturing facilities may cause us to experience a significant disruption of our operations and to pay penalties for the late delivery of our products. Labour unrest or strikes associated with our operations could also damage our reputation with customers or in the market generally. Since April 1, 2018, there has been one strike at one of our plants, which occurred at Fitwel Plant 1. The majority of workmen at Fitwel Plant belong to a trade union named All India Trade Union Congress. Approximately 90 non-unionized workmen at Fitwel Plant 1 tried to form another union (in which the affiliation was to be with Centre of Indian Trade Union). We refused to recognize the second union. As a result, the non-unionized faction of approximately 90 employees went on a strike from February 3, 2020 to June 6, 2020. On June 8, 2020, since it did not yield any result, the workmen decided to come back to normal work. Production at Fitwel Plant 1 was unaffected by the strike.

We have entered and may in the future enter into wage settlement agreements, including revised wage structures, ex-gratia payments, attendance bonuses and the provision or enhancement of insurance policies with unions or work councils under which we incur certain obligations or agree to certain limitations or conditions for a period of time with respect to certain personnel, workplaces, departments or product lines. If a greater percentage of our work force became unionised, our labour costs may increase. Historically, labour costs in the precision components industry in India have been significantly lower than labour costs in developed countries for comparable skilled technical personnel. However, in the long-term, increases in labour costs in India may make us less competitive unless we are able to increase our efficiency and productivity proportionately and we can pass on such costs in the prices that we charge our customers. Any significant increase in our labour costs may have an adverse effect on our business, results of operations and financial condition. In addition, our collective bargaining agreements are subject to renegotiation with the unions from time to time and it is possible that employees could demand for arrangements that could cause us to incur higher employment costs. Such agreements or arrangements could limit our ability to adjust workforce headcounts or salaries or to restructure our business in response to difficult economic conditions. This reduced flexibility could have an adverse effect on our business, results of operations and financial condition.

10. *If we fail to keep our technical knowledge confidential, it may erode our competitive advantage and have a material adverse effect on our business, financial condition, results of operations and cash flows.*

We possess technical knowledge and know-how about our products, including, in particular, engineering drawings, exclusively licensed-in technologies, data and manufacturing processes and materials expertise, machine building and automation capabilities that have been built up through our own research and development capabilities and grant us access to new technologies. While we rely on a combination of trademark laws, confidentiality procedures and contractual provisions to protect our intellectual property, we cannot be certain that the steps we have taken will prevent unauthorised use of our intellectual property. As a result, we cannot be certain that our technical knowledge will remain confidential. For details of our registered trademarks, see "Government and Other Approvals – Intellectual Property Rights" on page 323. We have not made any applications for registration of any copyrights or patents under applicable laws.

Certain proprietary knowledge may be leaked, either inadvertently or wilfully, at various stages of the production process. A significant number of our employees have access to confidential design and product information and there can be no assurance that this information will remain confidential. Moreover, certain of our employees may leave us and join our various competitors. Although we may seek to enforce non-disclosure agreements with our key employees

to protect our technical knowledge and other confidential information, we cannot guarantee that we will be able to successfully enforce such agreements. We also enter into non-disclosure agreements with a number of our customers and suppliers, but we cannot assure you that such agreements will be successful in protecting our technical knowledge and know-how. The potential damage from such disclosure is increased as our designs and products are not patented and thus, we may have no recourse against copies of our products and designs that enter the market subsequent to such leakage.

In the event that the confidential technical information in respect of our products or business becomes available to third parties or to the general public, any competitive advantage we may have over other companies in the precision components industry could be compromised. If a competitor is able to reproduce or otherwise capitalise on our technology, it may be difficult, expensive or impossible for us to obtain necessary legal protection. Moreover, we may not be able to detect any unauthorised use or to take appropriate and timely steps to protect our confidential technical information. Consequently, any leakage of confidential technical information may have a material adverse effect on our business, financial condition, results of operations and cash flows.

11. *Our incremental business pipeline may not be indicative of our future growth rate or new business orders we will receive in the future. Further, we may not realize all of the revenue expected from our incremental business pipeline.*

The amount of our sales to the customers, including the realization of future sales from awarded business or obtaining new business or customers, is inherently subject to a number of risks and uncertainties, including the accuracy of customer estimates relating to the volumes to be produced and sold and the timing of such production. Typically, we participate in a lengthy and rigorous vendor selection process with our customers, which can take up to two to three years from the date of the issue of a request for information or request for quote for securing new business. For more details on our customer acquisition process, see “*Our Business - Sales and Marketing - Customer Acquisition Process*” on page 176. Upon winning a business, we expect to receive all or a sizable portion of revenue from it. However, there is no assurance in relation to the sales volumes and revenue that the awarded business will eventually generate for us. Further, our customers may, due to various reasons, delay or cancel the launch of a new vehicle/product for which we have been awarded a contract to manufacture one or more parts for.

Since we do not have firm commitment long-term supply agreements with our customers, we may not have any recourse in the event of an unexpected delay or cancellation of a new vehicle/product for which we have been awarded a contract to manufacture one or more parts for. We base our growth projections, in part, on volume projections given to us by our customers. Under the letter of intent or purchase orders, our customers provide us only with forecast volume for the program and there is no commitment on the part of the customer to purchase the quantities specified in the volume projections. Such volume projections are based on a number of economic and business factors, variables and assumption, some or all of which may change or may not be accurate. Accordingly, our business pipeline and growth projections are not necessarily an accurate indication of what our actual sales and revenues from such orders will be, nor does it purport to project our results of operations, financial position or cash flows for any future period or date. Accordingly, we may not be able to realize all of the future sales represented by our business pipeline and this could have a material adverse effect on our business, cash flows, financial condition and results of operations.

12. *We may not be successful in implementing our growth strategies, such as developing multiple technology driven systems and components to cater to growing opportunities in electrification of vehicles and extending our existing capabilities to engineer additional precision components for non-automotive applications, which could have a material adverse effect on our business, financial condition, results of operations and cash flows.*

The success of our business depends greatly on our ability to effectively manage our business and implement our strategies. As part of our growth strategies, we plan to, among other things, develop multiple technology driven systems and components to cater to growing opportunities in electrification of vehicles and extend our existing capabilities to engineer additional precision components for non-automotive applications. For further details, see “*Our Business – Our Strategies*” on page 154.

In pursuing our growth strategy, we will require significant capital investments, which may have a material adverse effect on financial condition and results of operations. We may also be exposed to certain risks, including difficulties arising from operating a larger and more complex organisation; the failure to efficiently and optimally allocate management, technology and other resources across our organisation; the failure to compete effectively with competitors; the failure to increase our production capacity; the inability to obtain sufficient financing for expected capital expenditures or control our costs; unexpected delays (including as a result of the COVID-19 pandemic) in completing projects or acquisitions; delays in the granting of regulatory approvals; and unforeseen legal, regulatory, property, labour or other issues. For more information on how COVID-19 could adversely affect our business, financial condition, results of operations and cash flows, see “*-The COVID-19 pandemic has had, we expect it to continue to have, a material adverse effect on our business, financial condition, results of operations and cash flows*” on page 22.

As we continue our growth by introducing new products, we may encounter regulatory, personnel and other difficulties that may increase our expenses and/or delay our plans. Our success in entering new verticals and sectors is also subject

to factors including the nature and trends affecting these verticals and sectors, demand for precision components for products in these verticals and sectors, general economic conditions that affect customers in these verticals and sectors and competition in these verticals and sectors. In addition, the costs associated with entering and establishing ourselves in new geographical markets, and expanding such operations, may be higher than expected, and we may face significant competition in those regions. Our business may also be subject to many risks and challenges, including language barriers, cultural differences and other difficulties in staffing and managing overseas operations, inherent difficulties and delays in contract enforcement and the collection of receivables under the legal systems of some foreign countries, the risk of non-tariff barriers, other restrictions on foreign trade or investment sanctions, and the burdens of complying with a wide variety of foreign laws, rules and regulations.

There can be no assurance that our growth strategies will be successfully implemented or completed or that if completed, they will result in the anticipated growth in our revenues or improvement in our results of operations. We also cannot assure you that we will be able to continue to expand further, or at the same rate. Further, we expect our growth strategies to place significant demands on our management, financial and other resources and require us to continue developing and improving our operational, financial and other internal controls. We cannot assure you that our existing or future management, operational and financial systems, procedures and controls will be adequate to support future operations or establish or develop business relationships beneficial to future operations. Failure to manage growth effectively could have an adverse effect on our business, financial condition, results of operations and cash flows.

13. *We are subject to strict performance requirements, including, but not limited to, quality, delivery and development activities, and any failure by us to comply with these performance requirements may lead to the cancellation of existing and future orders, recalls or warranty and liability claims.*

As a precision engineered component manufacturer, we are engaged in the production and supply of critical and complex components with close tolerances, for which we warrant conformity to specifications and/or drawings provided by our customers and continued usage of the product for a specified time or cycles. Given the nature of our products and the sectors we cater to, product defect issues or our products failure to comply with quality or regulatory standards may lead to the cancellation of existing and future orders, product recalls and warranty and liability claims, any of which could have a material adverse effect on our business, financial condition, results of operations and cash flows.

Our contracts with customers have standard liability clauses in relation to quality and delivery of our products, which ordinarily do not have any limits. Accordingly, we are required to undertake or provide guarantees for such quality and delivery related obligations, which may or may not be capped. Depending on the terms under which we supply products, if we supply defective products, our customers may hold us responsible for some or all of (i) the repair or replacement costs of defective products and (ii) the costs of product recalls, product liability or warranty claims, which could adversely affect our reputation and business and, to the extent not covered by insurance, our results of operations, financial condition and cash flows. In addition, if our supply of defective products causes our customers to fail to comply with applicable regulations, it may also cause adverse consequences to be imposed on us, including warning letters, fines, injunctions, civil penalties, the refusal of regulatory authorities to grant approvals, delays, suspensions or withdrawal of approvals, licence revocation, seizures or recalls of products, operating restrictions and criminal prosecutions, any of which could materially harm our reputation, business, results of operations, financial condition and cash flows.

Furthermore, we may be subject to liability claims by third parties in the event that the use of any of our products results in personal injury or property damage, which could adversely affect our reputation and business and, to the extent not covered by insurance, our results of operations, financial condition and cash flows.

Defect issues or our products' failure to comply with quality standards could be caused by defects or quality issues in the products we buy from third parties and incorporate into the products we manufacture. There can be no assurance we would be able to recover from such third parties any losses we incurred as a result of any defects or failure of our products to comply with quality standards caused by products supplied to us by such third parties.

Although we have product liability insurance, we may not be covered for all situations that may arise with regard to any defects in our products. We have had warranty claims made against our products in the ordinary course of our business. In Fiscals 2021, 2020 and 2019, our warranty cost was nil, ₹ 21.12 million and ₹ 2.50 million, respectively, which represented nil, 0.14% and 0.02%, respectively, of our revenue from operations. In addition, a U.S.-based customer (the "**Tier 1 Supplier**") through its counsel, notified us via a demand letter dated July 1, 2021 of its intent to file a lawsuit against us in United States. This was in relation to the Tier 1 Supplier settling an OEM customer claim at EURO 3.70 million (approximately ₹ 325.90 million based on the exchange rate of 1 Euro = ₹ 88.0819 on July 1, 2021 (*source: reference rate of Financial Benchmark India Private Limited*)) for costs related to warranty and field service actions and recalls. While the Tier 1 Supplier has alleged that this was caused by supply of certain non-conforming products by us, we have refuted the allegations and disputed the Tier 1 Supplier's claim and made a provision of ₹ 7.50 million for the month ended July 31, 2021. Negotiations with the Tier 1 Supplier for settlement of this dispute are ongoing, failing which, we may proceed with litigation on the matter. If we are required to compensate the Tier 1 Supplier and we are

unable to reclaim such amount under our product liability insurance, it would have an adverse effect on our results of operations and cash flows.

We cannot guarantee that we can continue to comply with all regulatory requirements or the quality standards required by our customers. Due to the longer useful life of some of our products, it is possible that latent defects may not appear for several years.

14. *Our operations are subject to environmental, health and safety laws, which could result in material liabilities in the future.*

We are subject to applicable laws and regulations and customer specifications with respect to the protection of the environment and employee health and safety in each of the jurisdictions in which we operate. Our manufacturing processes and products are subject to stringent quality and safety standards and new laws and regulations may be imposed from time to time that may increase our compliance costs or restrict our operations. There can be no assurance that these requirements will not become more stringent over time.

The nature of our operations involves individuals working under potentially dangerous circumstances. Our operations are subject to significant hazards, including explosions, fires, mechanical failures and other operational problems, discharges or releases of hazardous substances, chemicals or gases and other environmental risks. We have experienced work-related injuries, such as burn injuries sustained by two contract workers in a fire accident at Plant 12, and a cut and crush injury sustained by a contract worker while removing scrap struck at the hydraulic cylinder area of a compactor machine at Plant 9. We paid for the medical expenses of the persons injured in the above-mentioned accidents. For further details on the fire accident at Plant 12, see “*Outstanding Litigation and Material Developments – Litigation involving our Company – Litigation against our Company – Actions by regulatory/statutory authorities*” on page 316. After each incident, we conducted a thorough internal investigation as to the reasons that the incident occurred and implemented policy and process changes aimed at minimising the risk of similar future incidents. However, there can be no assurance there will not be any fatalities, accidents or other incidents that occur at our facilities in the future and any such occurrence could result in claims for damages against us. Although we have insurance for personal injury claims, any damages that exceed our maximum coverage could have an adverse effect on our financial condition, results of operations and cash flows.

A risk of environmental liability is inherent in our manufacturing activities, and we are subject to numerous environmental laws and regulations in India and Sweden, which govern, among other things, air emissions, wastewater discharge and the handling, storage and disposal of hazardous substances and waste. Under these and other environmental laws and regulations, we could be held solely or jointly and severally responsible, regardless of fault, for the remediation of any hazardous substance contamination at our past and present facilities for which we may incur substantial costs or any consequences arising out of human exposure to such hazardous substances and could also be held liable for damages to natural resources or other environmental damage. If we fail to comply with environmental laws, regulations and permits, we could be subject to penalties, fines, restrictions on operations or other sanctions, and our operations could be interrupted or suspended. Any of the above actions may have a material adverse effect on our business, financial condition, results of operations and cash flows.

Set forth below is a summary of the two closure orders we have received in relation to non-compliance or alleged non-compliance with environmental laws since April 1, 2018:

- The Karnataka State Pollution Control Board (“**KSPCB**”) issued a closure order for Plant 12 dated February 11, 2019 in relation to breaches of sound pollution and vibration levels and Plant 12 ceased operating on that date. We filed our response in the form of a writ petition with the High Court of Karnataka at Bengaluru on February 16, 2019. On May 18, 2019, the KSPCB revoked the closure order dated February 11, 2019, permitting Plant 12 to recommence operations until further orders.
- The Uttarakhand Environment Protection and Pollution Control Board (“**UEPPCB**”) issued a closure order dated April 8, 2019 in which we were directed to close all operations at Plant 6 with immediate effect for exceeding prescribed inlet of common effluent treatment plant norms. The High Court of Uttarakhand at Nainital, in an order dated April 12, 2019 directed the Uttarakhand State Pollution Control Board to conduct a fresh inspection of the effluent treatment plant at Plant 6 to ascertain whether the chromium level still exceeded the maximum permissible limits. The inspection was conducted on April 16, 2019, which found the total chromium level at Plant 6 to be within prescribed limits, following which the UEPPCB issued a Disposal of Representation dated April 30, 2019 that revoked their closure order dated April 8, 2019 and permitted Plant 6 to operate the effluent treatment plant subject to certain conditions, including, but not limited to, submitting a performance guarantee of ₹ 0.50 million in favour of the UEPPCB.

Our Company has received notices and demand orders from the KSPCB, the UEPPCB and the Haryana State Pollution Control Board in relation to Plant 12, Plant 6, and Plant 4 respectively, for various non-compliances. These matters are currently pending. For information, see “*Outstanding Litigation and Material Developments – Litigation involving our*

Company – Litigation against our Company – Actions by regulatory/statutory authorities” on page 316. If these claims and lawsuits, individually or in the aggregate, are resolved against us, our business, results of operations, financial condition and cash flows could be adversely affected. Such incidents could also do lasting damage to our reputation among customers and the general public, even if we were not actually responsible for causing such damage and no fault on our part has been proven.

15. *We are exposed to risks associated with foreign exchange rate fluctuations.*

Although our Company’s reporting currency is in Indian Rupees, we transact a significant portion of our business in several other currencies. Our global footprint exposes us to certain currency exchange risks, arising primarily from our foreign currency receivables, import of raw materials and capital goods for our operations, export of goods and foreign currency borrowings. We hedge a significant portion of our net foreign exchange exposure through forward contracts and foreign currency borrowings. We are exposed to foreign currency risk on the unhedged exposure of foreign currency borrowings as well as translation of receivables, bank balances and borrowings. As of March 31, 2021, our total foreign currency receivables amounted to ₹ 1,668.47 million, our total cash and cash equivalents in foreign currency amounted to ₹ 51.80 million, our total foreign currency payables amounted to ₹ 237.60 million and our total foreign currency borrowings amounted to ₹ 290.04 million. As of March 31, 2021, the total value of our outstanding forward exchange contracts against receivables and borrowings amounted to ₹ 2,455.67 million. For additional quantitative disclosures on foreign currency risk, see “*Financial Information – Note 45-Financial Risk Management – (vi) Foreign currency risk*” on page 267.

Our net foreign exchange gains for Fiscals 2021, 2020 and 2019 amounted to ₹ 101.80 million, ₹ 104.64 million and ₹ 118.73 million, respectively.

Due to our inherent net foreign currency long position, depreciation of the Indian Rupee against foreign currencies will generally have a positive effect on our reported revenues and operating income and appreciation of the Indian Rupee against foreign currencies will generally have a negative effect on our reported revenues and operating income. There can be no guarantee that such fluctuations will not adversely affect our results of operations as we continue to expand our sales globally.

The realisation of any of these risks could have an adverse effect on our financial condition and results of operations.

16. *Seasonal or economic cyclicality coupled with reduced demand in the verticals and sectors in which we operate may have a material adverse effect on our business, results of operations and financial condition.*

Our business, results of operations, financial condition and cash flows are affected by levels of Indian and global vehicle production, particularly two-wheelers passenger vehicles and commercial vehicles (“CV”), and are therefore affected by factors that generally affect the automotive industry in India and globally. In Fiscals 2021, 2020 and 2019, 88.45%, 87.86% and 87.89%, of our revenue was from sales of products for use in the automotive sector. The automotive industry is sensitive to factors such as consumer demand, consumer confidence, disposable income levels, fuel prices and general economic conditions. The sales volumes and prices for the products sold by our OEM customers are also influenced by the cyclicality and seasonality of demand for these products, which in turn affect the demand for and sales volume of our precision forged and machined components for these products. Further, automotive production and demand may be subject to seasonality in some geographies, which may influence the demand for our products. On other occasions, an increase in our customers’ production may require us to commit more resources and cause a material increase in costs, including expedited shipping costs in order to meet our customers’ schedules.

During Fiscals 2016 to 2019, the Indian two-wheeler industry’s production increased at a CAGR of 9%, propelled by good monsoons, favourable economic situation, and rising exports. (*Source: the CRISIL Report, page 25*). In Fiscal 2020, there was 14.1% decrease in production volume from Fiscal 2019, owing to the transition to the Bharat Stage (BS)-VI norms, and in Fiscal 2021, there was a 12.6% decrease in production due to challenges heaped by the COVID-19 pandemic. (*Source: the CRISIL Report, page 25*). The Indian two-wheeler industry’s production is forecast by CRISIL Research to grow at a CAGR of 10.9% over Fiscal 2021 to Fiscal 2026. (*Source: the CRISIL Report, page 36*).

Production of passenger vehicles in India increased at a CAGR of 5.2% between Fiscals 2016 and 2019. (*Source: the CRISIL Report, page 50*). Production of passenger vehicles in India declined by 15% in Fiscal 2020 due to lower private consumption and inventory adjustment because of a change in emission norms from BS IV to BS VI, the liquidity crisis, and the onset of COVID-19. Production of passenger vehicles in India declined by approximately 11% in Fiscal 2021. (*Source: the CRISIL Report, page 50*). CRISIL Research estimates overall passenger vehicles production to grow at a CAGR of 10.8% from Fiscal 2021 to 2026. However, the risk of subsequent waves of COVID-19 cases and localised or extended lockdowns to control the spread of pandemic may have an impact on supply chains as well as sales. In such a case, the overall industry production is also likely to be adversely affected over the short term. (*Source: the CRISIL Report, page 58*).

According to the Ricardo Report, global light vehicle (passenger vehicle with a gross vehicle weight of 3.5 tonnes or

less, “**Light Vehicle**”) production remained flat between calendar years 2015 and 2019 and declined by approximately 17.8% in calendar year 2020 due to the COVID-19 pandemic. (Source: *the Ricardo Report, page 5*). Global Light Vehicle production is expected to grow at a CAGR of 5.4% from calendar years 2020 to 2025. (Source: *the Ricardo Report, page 5*).

Despite the above referenced forecasted increases in vehicle production, there is no assurance that vehicle production will recover even after the effects of COVID-19 are mitigated. Weak vehicle production would adversely affect demand for our components, which would adversely affect our business, results of operations, financial condition and cash flows.

Our business, results of operations, financial condition and cash flows are affected by the cyclical nature and trends of the non-automotive sectors, such as aerospace, off-road, agriculture, and the general economic conditions that affect our customers in these sectors, such as varying fuel and labour costs, price competition, regulatory scrutiny, declining activity levels, a decrease in outsourcing by customers or the failure of projected market growth to materialise or continue. In the event that these characteristics and trends adversely affect our customers in the non-automotive sector, the overall demand for our products may be reduced, resulting in a material adverse effect on the volume of our sales.

More generally, the automotive and non-automotive sectors that we cater to are affected by other factors such as national and international trade, changes in government policies, environmental, health and safety regulations, product recalls and oil prices. The demand for both automotive and non-automotive sectors declined due to the slowdown in economic growth being exacerbated by the COVID-19 pandemic. In the event of a decrease in demand for our customers’ products, or any development that may cause the supply of our components to customers in the automotive and non-automotive sectors to be less profitable, we may experience a material adverse effect on our business, results of operations financial condition and cash flows.

17. *A decline in the financial condition and results of operations of our customers could have a material adverse effect on our business, results of operations and cash flows.*

The financial condition and results of operations of our customers is affected by the sales of their products to their respective customers, which may be impacted by several factors, including general economic conditions and the COVID-19 pandemic. Any material weakening of the sales of our material customers could directly impact our business due to the potential postponement or cancellation of their planned purchases or the potential delay of their designs of new platforms.

In addition, significantly lower global production levels, tightened liquidity and increased cost of capital have historically combined to cause financial distress among many OEMs and other customers in the automotive industry and could have a similar affect in the future. Any decline in the creditworthiness of our customers in the future could result in an increased default risk with respect to our trade receivables from those customers. The average credit period on sales of goods for the year ended March 31, 2021 is 59 to 72 days. No interest is charged on trade receivables. Any such increase in default risk or decline in the financial condition or results of operations of our customers could have a material adverse effect on our business, results of operations, financial condition and cash flows.

18. *We are dependent on contract labour and if we are unable to obtain the services of skilled and unskilled workmen at reasonable rates it will have an adverse effect on our business and results of operations. In addition, even if we have already paid the independent contractors who directly engage these workmen, we may be responsible for paying the wages of such workers if the independent contractors default on their obligations to them, and such obligations could have an adverse effect on our cash flows until such amount is recovered from the independent contractors and on our results of operations and financial condition in the event we are unable to recover such amount from the independent contractors.*

Our workforce comprises contract workmen and employees. As at July 31, 2021, we had 4,533 contract workmen compared to 3,873 employees (which includes managerial staff, engineers, executives, trainee engineers, assistants, confirmed employees and trainees and apprentices). For Fiscals 2021, 2020 and 2019, our contract labour charges were ₹ 771.14 million, ₹ 689.87 million and ₹ 625.46 million, respectively, and our employee benefit expenses were ₹ 2,137.50 million ₹ 2,134.24 million and ₹ 2,174.07 million, respectively.

In order to retain flexibility and thereby control costs, we appoint independent contractors who in turn engage on-site contract labour for performance of certain of our operations in India. If we are unable to obtain the services of skilled and unskilled workmen at reasonable rates it will have an adverse effect on our business and results of operations. In addition, our manufacturing process is dependent on a technology-driven production system and any inability of the contract labourers to familiarize themselves with such technology could adversely affect our business and results of operations.

Although we do not engage these labourers directly, we may be held responsible for any wage payments to be made to such labourers in the event of default by such independent contractors. However, the amount paid in such an event can be recovered from the independent contractor. Nevertheless, any requirement to fund the wage requirements of the

engaged labourers may have an adverse effect on our cash flows until such amount is recovered from the contractor and on our results of operations and financial condition in the event we are unable to recover such amount from the independent contractor. In addition, under the Contract Labour (Regulation and Abolition) Act, 1970, as amended, we may be required to absorb a number of such contract labourers as permanent employees. Any such order from a regulatory body or court would increase our costs and decrease our flexibility to increase or decrease our workforce in response to changes in demand for our products and would have an adverse effect on our business and results of operations.

19. *We depend on third parties with whom we do not have long-term supply contracts for the supply of raw materials. A loss of suppliers or interruptions in the delivery of raw materials or volatility in the prices of raw materials on which we rely may have a material adverse effect on our business and results of operations.*

We are dependent on third party suppliers for the supply of our raw materials and assembled components. Our ability to identify and build relationships with reliable suppliers contributes to our growth and our successful management of our inventory as well as other aspects of our operations. In the absence of long-term contracts, we cannot assure you that a particular supplier will continue to supply our products in the future. There have been instances in the past where we experienced interruptions in the supply of raw materials, bought out components and assembly parts to us. Further, there can be no assurance that increased demand, capacity limitations or other problems experienced by our suppliers will not result in occasional shortages or delays in their supply of raw materials. Any change in the supply pattern of our raw materials can adversely affect our business and results of operations. Discontinuation of production by our suppliers, a failure by any of our suppliers to adhere to any delivery schedule or a failure to provide materials of the requisite quality could also hamper our production schedule and affect our business. If we were to experience a significant or prolonged shortage of raw materials from any of our suppliers and cannot procure the raw materials from other sources, we may be unable to meet our production schedules for our products and ship such products to our customers in timely fashion, which may adversely affect our customer relations and reputation. In such event, we may be required to airlift supplies to prevent assembly line stoppage at our customers' end. We may also be required to replace a supplier if its products or services do not meet our safety, quality or performance standards or if a supplier unexpectedly discontinues operations due to reasons beyond its or our control, including financing constraints caused by credit market conditions.

In addition, prices of certain raw materials we rely on, such as steel, stainless steel, aluminium and titanium, are linked to commodity markets and thus subject to fluctuation. There can be no assurance that the prices for these products will not be volatile in the future. While in practice we have passed the increase in the cost of raw materials onto our domestic customers, our cash flows may still be adversely affected due to any gap in time between the date of procurement of those raw materials and the date on which we can reset the component prices for our customers so as to account for the increase in the prices of such raw materials. In addition, we may not be able to pass all of our raw material price increases to our customers. Our ability to adjust pricing terms with customers varies based on our specific customer relationships, market practice with respect to the particular raw material or component and other factors such as raw material content and whether medium-term price fluctuations have been factored into our component prices at the time of price finalisation. As a result, for some of our export customers, we may in some instances bear the risk of price increases that occur. Our inability to adequately adjust our customer pricing in response to increases in prices of raw materials in a timely manner, or at all, could have a material adverse effect on our business, financial condition, results of operations and cash flows.

20. *Our insurance coverage may not be adequate to protect us against all potential losses, which may have an adverse effect on our results of operations, cash flows and financial condition.*

Our operations are subject to various risks, including breakdowns, failure or substandard performance of equipment, third party liability claims, labour disturbances, employee fraud and infrastructure failure, as well as fire, theft, robbery, earthquake, flood, acts of terrorism and other force majeure events. We maintain insurance policies for our manufacturing facilities in India and Sweden, including buildings, machinery and inventories, as well as for personal accident coverage, public liability coverage, product liability coverage and workmen compensation. In addition, we also maintain insurance policies covering directors' and officers' liability, general liability and policies that provide coverage for risks during the shipment of products. We are not insured against consequential damages, environmental damages, terrorist acts and war related events. For further details, see "Our Business – Insurance" on page 182. The table below sets forth the assets we have insured, the insured amount for such assets and the percentage of such assets insured as at March 31, 2021.

Particulars	As at March 31, 2021		
	Amount [A] (₹ in million)	Insured Amount [B] (₹ in million)	Insurance Coverage [C =A/B] (%)
Property, plant and equipment	10,000.05	9,347.00	93.47%
Capital work-in-progress	604.23	604.23	100.00%
Inventories	2,485.69	2,485.69	100.00%
Cash on hand	0.72	0.72	100.00%

While we believe that the insurance coverage which we maintain would be reasonably adequate to cover the standard risks associated with the operation of our business, we cannot assure you that any claim under the insurance policies maintained by us will be honoured fully, in part or on time, or that we have taken out sufficient insurance to cover all our losses. Our insurance policies may not provide adequate coverage in certain circumstances and are subject to certain deductibles, exclusions and limits on coverage. In addition, our insurance coverage expires from time to time. We apply for the renewal of our insurance coverage in the normal course of our business, but we cannot assure you that such renewals will be granted in a timely manner, at acceptable cost or at all. To the extent that we suffer loss or damage for which we did not obtain or maintain insurance, and which is not covered by insurance or exceeds our insurance coverage or where our insurance claims are rejected, the loss would have to be borne by us and our results of operations, cash flows and financial condition may be adversely affected. For Fiscals 2021, 2020 and 2019, our insurance claim receivable was nil, ₹ 106.50 million and ₹ 99.78 million, respectively, and we wrote off ₹ 11.26 million, ₹ 10.50 million and ₹ 9.23 million, respectively, in insurance claim receivable. For further risks relating to the effect on our business due to inadequacy of insurance coverage for product liability, see “– *We are subject to strict performance requirements, including, but not limited to, quality, delivery and development activities, and any failure by us to comply with these performance requirements may lead to the cancellation of existing and future orders, recalls or warranty and liability claims*” on page 30.

21. *Our business subjects us to risks in multiple countries.*

We manufacture our products primarily in India and to a lesser extent in Sweden and distribute our products globally, serving a customer base in India and 24 other countries spread across North America, Latin America, Europe, and Asia in Fiscal 2021. For details of the breakdown of our revenue from sale of products by geographical markets based on location of our customers, see “*Our Business – Our Strengths – Well diversified business model*” on page 149. Our operations are subject to risks that are specific to each country in which we operate, as well as risks associated with carrying out business operations on an international scale, including:

- Social, economic, political, geopolitical conditions and adverse weather conditions, such as natural disasters, civil disturbance, terrorist attacks, war or other military action, which may adversely affect our business and operations;
- Compliance with local laws, including legal constraints on ownership and corporate structure, environmental, health, safety, labour and accounting laws, which may impose onerous and costly obligations on our foreign subsidiaries;
- Changes in foreign laws, regulations and policies, including restrictions on trade, import and export licence requirements, and tariffs and taxes, intellectual property enforcement issues and changes in foreign trade and investment policies, which may affect our ability to both operate and the way in which we manage our business in the countries in which we operate; and
- Fluctuations in foreign currency exchange rates against the Indian Rupee, which may affect our results of operations, the value of our foreign assets, the relative prices at which we and foreign competitors sell products in the same markets and the cost of certain inventory and non-inventory items required for our operations. For more information, see “*-Fluctuations in the exchange rate between the Rupee and other currencies could have an adverse effect on the value of the Equity Shares in those currencies, independent of our results of operations*” on page 52.

In addition, changes in laws and regulations, more stringent enforcement or alternative interpretation of existing laws and regulations in jurisdictions in which we currently operate can change the legal and regulatory environment, making compliance with all applicable laws and regulations more challenging. The growth in size or scope of our business, expansion of our footprint in existing regions in which we operate and entry into new geographies also will expose us to regulatory regimes with which we have no prior direct experience. If any of these risks materialises, it could have a material adverse effect on our business, financial condition, results of operations and cash flows.

22. *We are dependent on third parties for the transportation and timely delivery of our products to customers.*

We rely on third parties for the transportation services for the timely delivery of our products to our customers located in India and other countries. Our domestic operations use a number of different modes of transportation, including road, air and rail. Where a shipment is outbound overseas, we use a number of different modes of transportation, including road, air and sea. We also utilise third-party freight forwarders who contract with the relevant ocean carriers and airlines on our behalf and engage third-party logistics service providers to provide support on our transportation requirements. Therefore, we face a risk that there could be deficiency or interruption in these third-party services.

Delays in customs clearance or disruptions of transportation services because of weather related problems, strikes, lockouts, inadequacy of road infrastructure, lack of containers or other events may affect our delivery schedules and impair our supply to our customers, for which we may be liable for damages. We do not have an insurance policy that covers us for liabilities for late delivery of products. In addition, production in our manufacturing facilities may be

adversely affected by supply chain disruptions due to COVID-19-induced lockdowns or any other lockdowns. For more information, see “-The COVID-19 pandemic has had, and we expect it to continue to have, a material adverse effect on our business, financial condition, results of operations and cash flows” on page 22. Although we do not enter into formal contracts with our third-party logistic service providers, we have purchase orders with these logistic service providers and hence are less exposed to fluctuations in transportation costs. However, in the event that these logistic service providers are unable to continue to provide these necessary services for our operations for reasons which are beyond our control and we are unable to secure alternate transport arrangements in a timely manner and at an acceptable cost, or at all, our business, results of operations and reputation may be materially adversely affected.

23. Any failure to compete effectively in the highly competitive precision components industry could have a material adverse effect on our business, financial condition, results of operations and cash flows.

We face competition in India and overseas in our business, which is based on many factors, including product quality and reliability, breadth of product range, product design and innovation, technology, manufacturing capabilities, distribution channels, scope and quality of service, price and brand recognition. We compete with global competitors to retain our existing business as well as to acquire new business. Some of our competitors may have certain advantages, including greater financial, technical and/ or marketing resources, which could enhance their ability to finance acquisitions, fund international growth, respond more quickly to technological changes and/ or operate in more diversified geographies and product portfolios.

In addition, we face increasing competition across our product portfolio. Some of our competitors may be able to produce similar or equivalent products at lower costs than we can produce them. Additionally, we face competitive price pressures from lower-cost manufacturers and we expect such price pressures to increase as our customers continue to expand their manufacturing footprints in emerging markets, thereby providing opportunities for local manufacturers to compete. Accordingly, we may not be able to compete effectively with our competitors, which may have an adverse effect on our business, financial condition, results of operations and cash flows.

Further, manufacturers that do not currently compete with us could expand their product portfolios to include products that would compete directly with ours. Changes in the product focus of larger manufacturers could also result in such manufacturers establishing relationships with our customers that may reduce or entirely replace our business with those customers. In addition, certain key customers to whom we currently sell certain products could decide to compete with us as manufacturers of these products. Any of these factors could have a material adverse effect on our business, financial condition, results of operations and cash flows.

24. There are outstanding legal proceedings involving our Company and one of our Subsidiaries.

There are outstanding legal proceedings involving our Company and one of our Subsidiaries, which are pending at different levels of adjudication before various courts, tribunals and other authorities. Such proceedings could divert our management’s time and attention and consume financial resources in their defence or prosecution. The amounts claimed in these proceedings have been disclosed to the extent ascertainable and quantifiable and include amounts claimed jointly and severally. Any unfavourable decision in connection with such proceedings, individually or in the aggregate, could adversely affect our reputation, business, financial condition and results of operations. A summary of such outstanding material legal proceedings as on the date of this Red Herring Prospectus is set out below:

Nature of cases	No. of cases	Total amount involved (₹ in million)
Litigation involving our Company		
Against our Company		
Action taken by statutory and regulatory authorities	6	26.06
Direct tax cases	7	46.49
Indirect tax cases	19	152.11
Litigation involving our Subsidiaries		
Against Fitwel		
Actions taken by statutory and regulatory authorities	-	-
Direct tax cases	1	5.59
Indirect tax cases	1	1.31

We cannot assure you that any of these matters will be settled in favour of our Company or Fitwel, or that no additional liability will arise out of these proceedings. For further details, see “Outstanding Litigation and Material Developments” on page 316.

25. We require certain licenses, permits and approvals in the ordinary course of business, and failure to obtain or retain them in a timely manner may have a material adverse effect on our business and results of operations.

We are required to obtain and maintain a number of statutory and regulatory licenses, permits and approvals in India and in Sweden, generally for carrying out our business and for each of our manufacturing facilities. For further details

on regulatory licenses, permits and approvals in India, see “*Government and Other Approvals*” on page 321. A majority of these approvals, including the consent to establish and operate under environmental laws, are granted for a limited duration and require renewal from time to time. While we have applied for some of these approvals, we cannot assure you that such approvals will be issued or granted to us in a timely manner, or at all. For instance, our applications for Plant 3 to (i) renew the consent to establish, and (ii) obtain the hazardous waste management authorization, are still pending. For details, see “*Government and Other Approvals – Pending Approvals*” on page 322. If we do not receive such approvals or are not able to renew the approvals in a timely manner, our business and results of operations may be materially adversely affected.

Further, the licenses, permits and approvals required by us are subject to several conditions and we cannot assure you that we will be able to continuously meet such conditions, which may lead to cancellation, revocation or suspension of the relevant licenses, permits and approvals. If there is any failure by us to comply with the applicable regulations or if the regulations governing our business are amended, we may incur increased compliance costs, be subject to penalties, have our licenses, approvals and permits revoked or suffer a disruption in our operations, any of which may have a material adverse effect on our business and results of operations.

26. *Our financing agreements contain covenants that limit our flexibility in operating our business and there have been instances of non-compliance with covenants under financing agreements in the past.*

We are bound by restrictive and other covenants in our facility agreements with various lenders, including but not limited to, restrictions on the utilisation of the loan for certain specified purposes, timely provision of information and documents, timely creation of security, obtaining prior consent from existing lenders and maintenance of financial ratios, including debt to tangible net worth, debt-service coverage ratio and fixed assets coverage ratio. Further, most of our loan documents and some of the loans availed by our Subsidiaries contain restrictive covenants that require us to obtain the prior written approval from the appropriate lender for various corporate actions, including effecting any change in the management or control or the majority shareholding of our Company, any merger, amalgamation or other restructuring that affects the control of the existing Shareholders over our Company, or any amendment or modification of the MoA of our Company. In addition, our terms loans and working capital facilities are secured by a charge on, among others, our immovable properties, moveable assets and current assets.

In January 2021, a lender notified our Company that our Company had breached a covenant by not informing the lender of our Company’s additional investment in Sansera Mauritius. While the lender in the instant case did not impose any penalty or take any adverse action against our Company, our Company cannot assure that in case of any such breach in future, our lenders will not exercise their rights against us. Any such exercise of rights may have a material adverse effect on our financial condition, results of operations and cash flows and adversely affect our reputation.

Our failure to comply with restrictive covenants or to obtain our lenders’ consent to take such actions in a timely manner or at all could also result in an event of default, which may accelerate repayment of the relevant loans or increase applicable interest rates or even trigger cross-defaults under our other financing agreements or other agreements or instruments containing cross-default provisions. Further, a breach of our facility agreements may also trigger a right of the lenders to enforce the security provided. An event of default may also affect our ability to raise new funds or renew maturing borrowings that may be needed to conduct our operations and pursue our growth initiatives. In addition, our ability to obtain further financing on terms and conditions acceptable to us could be severely and negatively impacted as a result of these restrictions and breaches, and we cannot guarantee that we will be able to repay our loans in full, or at all, upon receiving a recall or acceleration notice, or otherwise. A failure to comply with repayment schedules and other conditions prescribed under financing arrangements may have an adverse effect on our credit ratings, and any loan agreement termination and subsequent action taken by our lenders may individually or in aggregate have an adverse effect on our business, results of operations, cash flows and financial condition.

As of July 31, 2021, our aggregate outstanding fund and non-fund-based borrowings was ₹ 6,435.47 million. For details, see “*Financial Indebtedness*” on page 313.

27. *A substantial portion of our assets are hypothecated or mortgaged in favour of lenders as security for some of our fund-based and non-fund-based borrowings. Our lenders may enforce the security in the event of our failure to service our debt obligations which may adversely affect our business, financial condition and results of operations.*

As of July 31, 2021, we had total secured fund and non-fund-based borrowings of ₹ 6,337.34 million. These borrowings are secured, among others, through a charge by way of hypothecation on our present and future current assets and fixed assets as well as through mortgage on our land and buildings. See “*Financial Indebtedness*” on page 313. As these assets are hypothecated or mortgaged, our rights in respect of transferring or disposing of these assets are restricted. Further, in the event we fail to service our debt obligations, the lenders have the right to enforce the security created in respect of our secured borrowings. If the lenders choose to enforce security and dispose our assets to recover the amounts due from us, our business, financial condition and results of operations may be adversely affected.

28. ***Some of our manufacturing facilities are operated on industrial land allotted to us by industrial development corporations. Failure to comply with the conditions of use of such land could result in an adverse effect on our business, results of operations and financial condition.***

As of July 31, 2021, we had 13 manufacturing facilities that were constructed on industrial land allotted to us by state-owned industrial development corporations (“IDC”). Under the terms of the allotment and the lease agreements, we are required to comply with various conditions such as achieving the investment commitment set out in the project report and adhering to the timelines for completion of setting up of the manufacturing facility and commencement of manufacturing activity. Furthermore, we are required to obtain IDC approval for assigning, underletting or parting with the leased premises. In the event that we fail to meet these conditions, we may be required to pay a non-refundable premium to the relevant IDC to extend the deadline for meeting the commitments or to forgo pursuing certain corporate actions. In addition, according to the statutory rules under which the IDCs function, IDCs also retain the power to cancel allotment of land in the event of breach of any rules of allotment.

As we are constantly looking to expand our business, we may be required to enter into arrangements with IDCs to secure land for setting up new manufacturing facilities or expanding existing ones. However, there are several factors and variables such as delay in receipt of confirmed orders from our customers, inability to arrange for manpower, inability to raise debt for unforeseen increases in project outlays and delay in securing requisite licences and approvals which could delay the completion of the manufacturing facility beyond the timeline agreed upon with the relevant IDC. In such an event, we may be required to pay a premium or face cancellation of land allotment, which could adversely impact our business. Further, our Company has received a notice from the Karnataka Industrial Areas Development Board (“KIADB”) in relation to the execution of a sale deed for a plot of land our Company had leased pursuant to an agreement dated July 12, 2002. For information, see “*Outstanding Litigation and Material Developments – Litigation involving our Company – Litigation against our Company – Actions by regulatory/statutory authorities*” on page 316.

29. ***Some of our Directors and Promoters have interests other than reimbursement of expenses incurred and normal remuneration or benefits in our Company.***

Subramonia Sekhar Vasam and Fatheraj Singhvi, both of whom are Directors and Promoters, and Unni Rajagopal Kothenath and Devappa Devaraj, both of whom are Promoters, are interested in our Company to the extent of the Equity Shares held by them in our Company, and any dividends, bonuses or other distributions on such Equity Shares. For further details, see “*Our Management*”, “*Our Promoters and Promoter Group*” and “*Financial Statements*” on pages 197, 211 and 219, respectively.

Further, pursuant to the terms of the shareholders’ agreement dated May 29, 2013 executed between our Company, Client Ebene Limited and CVCIGP II Employee Ebene Limited, Subramonia Sekhar Vasam, Fatheraj Singhvi, Unni Rajagopal Kothenath, Devappa Devaraj, Karthik Das and Anjana Iyer, as amended on March 23, 2016 (“**Shareholders Agreement**”), and further amended pursuant to the waiver and termination agreement dated August 8, 2018, as amended (“**Waiver and Termination Agreement**”), in the event of a full cash exit by Client Ebene Limited and CVCIGP II Employee Ebene Limited, if the amount realised by Client Ebene Limited and CVCIGP II Employee Ebene Limited, is in excess of the internal rate of return of 25.00% on the investment amount (an aggregate of subscription amount and purchase consideration), our Promoters are entitled to receive an incentive (by way of cash or any other methods) from Client Ebene Limited and CVCIGP II Employee Ebene Limited, based on the formula set out under the Shareholders Agreement as amended by way of the Waiver and Termination Agreement, subject to Shareholders’ approval. For further details, see “*History and Certain Corporate Matters - Summary of Key Agreements for our Company*” on page 194.

30. ***We did not meet the required minimum expenditure towards corporate social responsibility (“CSR”) activities under the Companies Act, 2013 for Fiscals 2021, 2020 and 2019 and we may be subject to penalties.***

As per Section 135 of the Companies Act, 2013, a company, meeting the applicability threshold, is required to spend at least 2% of its average net profit for the immediately preceding three financial years on CSR activities. The details with respect to our required minimum expenditure on CSR activities and our actual expenditure towards CSR activities for Fiscals 2021, 2020 and 2019, on a consolidated basis, are set forth below:

(₹ in million)

Particulars	Fiscal 2021	Fiscal 2020	Fiscal 2019
Gross amount required to be spent by the Group during the year	29.53	29.81	23.79
Amount spent during the year on:			
i) Construction/acquisition of any asset	0.31	6.22	-
ii) On purpose other than (i) above	20.42	23.78	14.38
Total	20.73	30.00	14.38
Amount unspent during current financial year	8.80	N.A. ⁽¹⁾	N.A. ⁽¹⁾

Note: N.A. means not applicable, as this amount was not required to be calculated and included in our financial statements.

We failed to meet the required minimum expenditure towards CSR activities for Fiscal 2020 (on a cumulative basis) and Fiscal 2019. However, there are no potential penalties for failing to do so.

We also failed to meet the required minimum expenditure towards CSR activities for Fiscal 2021. Effective January 22, 2021, the Companies (Corporate Social Responsibility Policy) Amendment Rules, 2021 stipulate that a company shall be required to transfer the unspent funds mandated to be spent towards CSR activities to a special account called the “Unspent Corporate Social Responsibility Account” within 30 days from the end of the financial year and this amount is required to be spent within a period of three years from the date of the transfer. In the event a company fails to spend the unspent CSR amount within a period of three years, the amount is required to be transferred to a fund specified under Schedule VII of the Companies Act. If a company fails to do so, it may be required to spend twice the amount required to be allocated towards CSR activities for any given financial year, or ₹ 10.00 million, whichever is less, and every officer of the company who is in default may be liable to a penalty of one-tenth of the amount required to be transferred by the company to the Unspent Corporate Social Responsibility Account, or ₹ 0.20 million, whichever is less. While our Company has transferred the unspent amount to a special account, it was transferred after the stipulated 30 days. Further, in the event our Company is unable to comply with the above provisions, it could adversely affect our reputation, business, financial condition, results of operations and cash flows.

31. *Our Company was incorporated in 1981 and we are unable to trace some of our historical records. We cannot assure you that no legal proceedings or regulatory actions will be initiated against our Company in the future in relation to the missing filings and corporate records, which may impact our financial condition and reputation.*

We have been unable to trace a number of documents, including the form filings, share transfer deeds and corresponding resolutions maintained by our Company. We may be unable to obtain copies of these documents in the future to ascertain details of the relevant transactions. For instance, we have been unable to trace the following corporate records and regulatory filings of our Company:

- Copies of certain internal secretarial records, including the original memorandum of association (“**MoA**”) of our Company, board and shareholder resolutions, certain RoC form filings and share transfer deeds from the date of incorporation until 1987;
- Form-2 filed with the RoC in relation to the allotment of an aggregate of 970 equity shares of our Company to our Promoters in Fiscal 1984;
- Copies of board and shareholder resolutions and Form 32 filed with the RoC in relation to the appointment of our Managing Director, Subramonia Sekhar Vasan, at the time of incorporation and the board and shareholder resolutions for the appointment of our Joint Managing Director, Fatheraj Singhvi as a director on March 3, 1991;
- Copies of share transfer forms, dematerialised statements for the transfer of certain shares and copies of circular resolutions in respect of certain share transfers;
- Typographical errors with respect to the date of appointment in the filings of relevant forms with the RoC with respect to the appointment of our Independent Directors; and
- Irregular filings of relevant forms with the RoC with respect to the appointment of Bindiganavile Raghunath Preetham as CEO and Ramakrishnan Subramanian as CFO of our Company in the years 2014 and 2016, respectively.

We have been unable to trace these documents despite conducting a search at the relevant Registrar of Companies and may be unable to obtain copies of these documents in the future to ascertain details of the relevant transactions. Accordingly, for the period between the date of our incorporation and 1984, we are unable to confirm details of any corporate action undertaken by our Company, including acquisitions of any business or undertakings, revaluation of assets, entry into any scheme of amalgamations, public offerings of debt securities, instances of strikes, lockouts or cost overruns and any default in repayment or rescheduling of borrowings from financial institutions or banks. Further, there have also been past instances where our Company made only a post facto noting of a share transfer (as opposed to granting an in-principle approval) and in one instance where our Company has not reflected an increase in the authorised share capital by way of an amendment to the MoA.

While no legal proceedings or regulatory action has been initiated against our Company in relation to the unavailable filings and statutory lapses as of the date of this Red Herring Prospectus, we cannot assure you that such proceedings or regulatory actions will not be initiated against our Company in the future in relation to the missing filings and corporate records. The actual amount of the penalty which may be imposed or loss which may be suffered by our Company cannot be ascertained at this stage and depends on the circumstances of any potential action which may be brought against our Company. We cannot assure you that any such proceedings will not have a material adverse effect on our financial condition or reputation.

Further, in the past there have been instances where our Company had not filed a return in form III, reflecting beneficial ownership of certain Shareholders, for which our Company had filed a compounding application. While the said non-compliance was compounded and the relevant penalty was paid by our Managing Director, Subramonia Sekhar Vasan

and Joint Managing Director, Fatheraj Singhvi, we cannot assure you that such non-compliances will not occur in future. Such non-compliance may, among other things, result in imposition of fines or penalties, which would have an adverse effect on our financial condition, results of operations and cash flows.

32. *Our estimates of production volumes may not correspond to the actual demand for our products.*

We estimate our production volumes based on close customer dialogue, purchase orders, historical production volumes by our customers, our experience and general economic and market conditions. However, we are unable to assure that the demand for our products will develop in line with our estimates. The actual demand for our products for a few of our customers has varied significantly from their estimated sales volumes in the past. There is no assurance that we will be able to plan our production schedules to meet the actual requirements. In addition, regardless of the accuracy of such indicators, factors outside our control may require revision of our estimates. If we over-estimate the volume of products we expect to sell, we will have excess production capacity which may reduce operational efficiency and the margins on the products sold. If we underestimate the volume of products we need to produce at any of our manufacturing facilities, or fail to order a sufficient volume of supplies and input materials from our third-party suppliers, we may be unable to meet customer orders, which may affect our reputation or lead to a discontinuation of future orders from customers. In some cases, our customers have required a rapid increase in production, which placed an excessive burden on our resources and caused a material increase in costs, including the costs of expedited shipping. As a result of production delays, we may also be required to airlift supplies to prevent assembly line stoppage at our customers' end, which may have a material adverse effect on our results of operations and financial condition. Failure to meet customer orders may also occur because existing manufacturing facilities and other equipment do not have sufficient capacity or we have an inaccurate level of inventory holding or the costs of transporting goods from one site to another would be uneconomical.

33. *We are required to obtain and maintain quality and product certifications for certain countries and customers.*

In some countries, certain certifications for products with regard to specifications and quality standards are necessary or preferred in order for these products to be accepted by customers and markets. As such, we need to be able to obtain and maintain the relevant certifications so that our customers are able to sell their products, which include precision forged and machined components that are manufactured by us, in these countries. In addition, some customers also require us to maintain certain standards and conduct inspections at regular intervals to ensure that we maintain these standards. We are materially compliant with each of these certifications in the relevant jurisdictions and have not had any such certification revoked in the past. However, any failure to meet or maintain the requirements needed to secure or renew such certifications could result in a material adverse effect on our business in the relevant countries and with the relevant customers.

34. *Start-up costs and inefficiencies relating to new products and OEM approval processes could have a material adverse effect on our results of operations and financial condition.*

New products that our customers commission us to develop and manufacture often entail material start-up costs with respect to product design and development, material sourcing, testing and validation to match the customers' specifications and approval processes, as well as establishing additional production lines or new manufacturing facilities where required. If we are unable to recoup start-up costs, manage our labour and equipment resources effectively, or correctly estimate the required time and resources in developing new products, our results of operations may be adversely affected. In addition, if any of these new products were terminated or our OEM customers shift their base of operations to a location where we do not have a manufacturing facility, our results of operations could be adversely affected, particularly in the short-term. Accordingly, we may not be able to adequately recover these start-up costs or replace anticipated revenues from any such new products, which may have a material adverse effect on our results of operations and financial condition.

35. *We may incur significant costs in connection with ongoing efforts by our customers to restructure their operations.*

The automotive industry continues to experience fluctuating production volumes and sales levels in certain geographic markets. In response to these conditions, some OEMs continue to explore restructuring of their operations, cutting or postponing vehicle production programmes, or cancelling or scaling back future product plans. Further, as OEMs follow a trend of localisation of production in certain lower-cost countries, they have and may in the future close plants in certain locations while opening plants in new locations, requiring suppliers to follow this geographic migration. Our ability to relocate our facilities is dependent on the availability of land and other factors including obtaining consent from certain customers. In the event that restructuring efforts by certain of our customers affect vehicle programmes for which we supply or are scheduled to supply components, we may need to restructure our own operations in order to align them with the evolving needs of our customers. In such event, we may incur restructuring, relocation, downsizing and other significant non-recurring costs in our operations for which we are not compensated under the terms of our contracts with our customers, which could have an adverse effect on our results of operations and financial condition.

36. *We have substantial capital expenditure and working capital requirements and may require additional financing to meet those requirements, which could have an adverse effect on our results of operations and financial condition.*

Our business is capital intensive as we seek to add to and upgrade our existing manufacturing facilities, increase our product portfolio and invest in researching and developing new technologies and products, among others. For Fiscals 2021, 2020 and 2019, our additions to property, plant and equipment were ₹ 1,484.29 million, ₹ 1,408.18 million and ₹ 3,081.15 million, respectively. The actual amount of our future capital requirements may differ from estimates as a result of, among other factors, unforeseen events beyond our control, such as lockdowns due to the COVID-19 pandemic, unforeseen delays or cost overruns, unanticipated expenses, regulatory changes, economic conditions, engineering design changes, weather related delays, technological changes, additional market developments and new opportunities in the precision components industry. Our sources of additional financing where required to meet our capital expenditure plans may include the incurrence of debt, the issuance of equity or debt securities or a combination of both. If we decide to raise additional funds through the incurrence of debt, our interest and debt repayment obligations will increase, which may have a significant adverse effect on our profitability and cash flows. We may also become subject to additional covenants, which could limit our ability to access cash flows from operations and undertake certain types of transactions. Any issuance of equity, on the other hand, could result in a dilution of the shareholding of existing shareholders.

In many cases, a significant amount of our working capital is required to finance the purchase of raw materials and the designing and manufacturing of products before payments are received from customers. Our working capital requirements may increase if the payment terms in our agreements or purchase orders include reduced advance payments or longer payment schedules. These factors may result, and have in the past resulted in, increases in the amount of our receivables and current borrowings. Continued increases in our working capital requirements may have an adverse effect on our results of operations and financial condition.

37. *Any downgrade of our credit ratings may lead to an increase in our borrowing costs and constrain our access to borrowings.*

The cost and availability of borrowings is dependent, among other factors, on our short-term and long-term credit ratings. Ratings reflect a rating agency's opinion of our financial strength, operating performance, strategic position, and ability to meet our obligations. Our Company's long-term bank facilities are domestically rated by ICRA as [ICRA] AA-/Stable and by India Ratings as Ind AA-/Stable and our Company's short-term bank facilities are domestically rated by ICRA as [ICRA] A1+ and by India Ratings as Ind A1+. Any deterioration in our financial strength, operating performance or strategic position or a general downturn in the industry may result in a downgrade of our credit ratings, and may in turn lead to an increase in our borrowing costs and constrain our access to funds and debt markets, which could adversely affect our business growth. In addition, any downgrade of our credit ratings could result in a default under our financing arrangements or lenders imposing additional terms and conditions in any future financing or refinancing arrangements.

38. *We are exposed to counterparty credit risk of our customers and any significant delay in receiving payments or non-receipt of payments may have a material adverse effect on our results of operations.*

We are exposed to counterparty credit risk of our customers and any significant delay in receiving payments or non-receipt of payments may have a material adverse effect on our results of operations, financial condition and cash flows. There is no assurance that we will accurately assess the creditworthiness of our customers. Macroeconomic conditions, such as a credit crisis in the global financial system or global economic uncertainty, or a pandemic, such as the COVID-19 pandemic, could lead to deterioration in our customers' financial condition and results of operations, which could limit their access to the credit markets, thereby increasing their risk of insolvency or bankruptcy. Such conditions could cause our customers to delay payment, request modifications of their payment terms, or default on their payment obligations to us, all of which may increase our receivables. For details on the ageing of trade receivables, see "*Financial Statements – Note 12 – Trade Receivables*" on page 249. Timely collection of dues from customers also depends on our ability to complete our contractual commitments and subsequently bill for and collect from our clients. If we are unable to meet our contractual obligations, we may experience delays in the collection of, or be unable to collect, our customer balances, which may have a material adverse effect on our results of operations and cash flows.

39. *The acquisition of other companies, businesses or technologies could result in operating difficulties, dilution and other adverse consequences.*

As part of our business diversification strategy, we may from time to time pursue acquisitions to expand our business. We cannot assure you that we will be able to identify suitable acquisition, strategic investment or joint venture opportunities at acceptable cost and on commercially reasonable terms, obtain the financing necessary to complete and support such acquisitions or investments, integrate such businesses or investments or that any business acquired or investment made will be profitable. If we attempt to acquire companies outside of India, we may not be able to satisfy certain Indian regulatory requirements for such acquisitions and may need prior approval from the RBI, which we may not be able to obtain in time or at all.

In addition, acquisitions and investments involve a number of risks, including possible adverse effects on our results of operations, exposure to future funding obligations, diversion of management's attention, failure to retain key personnel, currency risks, risks associated with unanticipated events or liabilities, possible contravention of applicable laws in

relation to investment and transfer of shareholding, including any pre-emptive rights of existing shareholders of such entities and difficulties in the assimilation of the operations, technologies, systems, services and products of the acquired businesses or investments, as well as other economic, political and regulatory risks. Any failure to achieve successful integration of such acquisitions or investments could have a material adverse effect on our business, financial condition and results of operations. Future acquisitions could result in potentially dilutive issuances of our equity securities, the incurrence of debt, contingent liabilities or amortization expenses, or write-offs of goodwill, any of which could harm our financial condition and may have an adverse effect on the price of the Equity Shares.

40. *We might unintentionally infringe upon the intellectual property rights of others, any misappropriation of which could harm our competitive position.*

While we take care to ensure that we comply with the intellectual property rights of others, we cannot determine with certainty as to whether we are infringing on any existing third-party intellectual property rights. We may therefore be susceptible to claims from third parties asserting infringement and other related claims. If claims or actions are asserted against us, we may be required to obtain a licence, modify our existing technology or cease the use of such technology and design a new non-infringing technology. Such licences or design modifications can be extremely costly. Furthermore, necessary licences may not be available to us on satisfactory terms, if at all. In addition, we may decide to settle a claim or action against us, the settlement of which could be costly. We may also be liable for any past infringement. Any of the foregoing could adversely affect our business and results of operations.

In certain cases, our customers share their intellectual property rights in the course of the product development process that we carry out for them. If our customer's intellectual property rights are misappropriated by our employees in violation of any applicable confidentiality agreements, our customers may seek damages and compensation from us. This could have an adverse effect on our business, results of operations and damage our reputation and relationships with our customers.

41. *Any shutdown of our manufacturing facilities may have an adverse effect on our business, results of operations and financial condition.*

Our manufacturing facilities are subject to operating risks, such as the breakdown or failure of equipment, power supply or processes, industrial accident, labour disputes, natural disasters, epidemics or pandemics, such as the COVID-19 pandemic, and the need to comply with the directives of relevant government authorities. The assembly lines of our customers rely significantly on the timely delivery of our components and our ability to provide an uninterrupted supply of our products is critical to our business. In addition, certain of our customers may impose significant penalties on component manufacturers for any stoppage in any assembly line, caused either by delayed delivery of a component or a defect in the components delivered. Our customer relationships, business and results of operations may be adversely affected by any disruption of operations of our product lines, including as a result of any of the factors mentioned above. Any shutdown or operational failure of our manufacturing facilities may also result in a reduction in the capacity utilisation levels at our manufacturing facilities, which may have an adverse effect on our results of operations. For details on the effects of COVID-19, including the periods during which our manufacturing facilities were shut down or operated at reduced capacity due to COVID-19, see “-The COVID-19 pandemic has had, and we expect it to continue to have, a material adverse effect on our business, financial condition, results of operations and cash flows” on page 22.

42. *Discontinuance or non-availability of fiscal benefits enjoyed by us or our inability to comply with related requirements may have an adverse effect on our business and results of operations.*

We enjoy certain fiscal benefits on account of policies of the Government of India, including the Duty Drawback Scheme (“**DDS**”) and the Export Promotion Capital Goods Scheme (the “**EPCG Scheme**”). In the case of our export products, with our current product mix, the rate of DDS ranges from 1.6% to 2% of free on board (“**FOB**”) value of exports. The EPCG scheme allows imports at concession rates of custom duty and requires the importer to export a specified value of goods over a period of six years from the licence date. A 50% export obligation is required to be fulfilled within first four years with the remaining 50% within the next two years. Non-fulfilment of such obligations may result in confiscation of capital goods imported under this scheme along with applicable import duties and other penalties as set out in this scheme. As of March 31, 2021, our export obligation under the EPCG scheme was ₹ 547.25 million. We have not been subject to any penalties on account of failure to meet our export obligations in the past since the value of exports undertaken by us has exceeded our export commitments. However, in the event of any default under the EPCG Scheme, our results of operations may be adversely affected. As we seek to export a larger proportion of our products outside of India, any changes in the policies of the Government of India may have a proportionately greater adverse effect on our business and results of operations.

Prior to January 1, 2021, we were also eligible to avail the incentives under the Merchandise Exports from India Scheme (“**MEIS**”), pursuant to which, we could use duty credit scrips for payment of import duty obligations or sell such duty credit scrips in the open market to other importers. In the case of our export products, with our product mix, the average rate of MEIS was approximately 2% to 3% of FOB value of exports for Fiscal 2020. However, the Ministry of Finance,

GoI has discontinued MEIS with effect from January 1, 2021 and announced a scheme for remission of duties and taxes on export products (“**RODTEP Scheme**”) for exporters, which is effective from January 1, 2021. The incentive rates under the RODTEP Scheme were notified on August 17, 2021. The incentive rates under the RODTEP Scheme for our products range from 1%-2% (subject to weight based capping for certain products), which are lower than the discontinued MEIS. The GoI has also announced the Production Linked Incentive Scheme (“**PLI Scheme**”) for various industries, including the automotive industry, which is yet to be notified by the GoI. Since MEIS is already discontinued and specific details of the PLI Scheme are unavailable, we are unable to ascertain whether the discontinuation of the MEIS will have a positive or negative effect on our business and results of operations.

Our export incentive benefit for Fiscals 2021, 2020 and 2019 was ₹ 103.52 million, ₹ 131.66 million and ₹ 146.23 million, respectively, constituting 0.67%, 0.90% and 0.90%, respectively, of our revenue from operations.

43. *Failure or disruption of our information technology (“IT”) systems may adversely affect our business, financial condition, results of operations and cash flows.*

Our ability to keep our business operating depends on the proper and efficient operations and functioning of various IT systems, which are susceptible to malfunctions and interruptions. Our design and engineering facilities comprise IT enabled processes, such as CAD, CAM and CAE facilities and design software. We also have a supplier management system and have implemented various SAP platform solutions to manage key areas of our operations, including production, materials, maintenance and human resource functions.

We may be subject to disruptions of our IT systems arising from events that are wholly or partially beyond our control or the control of our third-party vendors (including, for example, damage or incapacitation by human error, natural disasters, electrical or telecommunication outages, sabotage, computer viruses, hacking, cyber-attacks or similar events, or loss of support services from other third parties, such as internet backbone providers). Any failure or disruption in the operation of these systems or the loss of data due to such failure or disruption may affect our ability to plan, track, record and analyse work in progress and sales, process financial information, manage product lifecycle, manage our creditors and debtors, manage payables and inventory or otherwise conduct our normal business operations, which may increase our costs and have a material adverse effect on our business and results of operations.

We have a data centre in Bidadi, Karnataka that is managed for us by a third party. The data stored at the data centre in Bidadi, Karnataka is backed up to a data centre in Mumbai, which is managed by a third party. However, if for any reason the switch over to the back-up systems do not take place or if a calamity occurs in both places such that our data is compromised at both places, it would have a material adverse effect on our business, financial condition, results of operations and cash flows.

44. *We have power and water requirements and any disruption to our power or water sources could increase our production costs.*

We require power and water for our manufacturing facilities, and energy costs represent a significant portion of the production costs for our operations. For Fiscals 2021, 2020 and 2019, our power and fuel charges were ₹ 670.65 million, ₹ 750.55 million and ₹ 841.31 million, constituting 4.27%, 5.09% and 5.13%, respectively, of our total income. If energy or water costs were to rise, our production costs could increase if we are unable to increase the prices for our products enough to offset these increased costs. If electricity or water supplies or supply arrangements were disrupted, we may need to rely on alternative sources, which may not be able to consistently meet our requirements. Interruptions of electricity supply can also result in production shutdowns, increased costs associated with restarting production and the loss of production in progress.

45. *If we fail to maintain an effective system of internal controls, we may not be able to successfully manage or accurately report our financial risks.*

Effective internal controls are necessary for us to prepare reliable financial reports and effectively avoid fraud. Moreover, any internal controls that we may implement, or our level of compliance with such controls, may deteriorate over time, due to evolving business conditions. There can be no assurance that additional deficiencies in our internal controls will not arise in the future, or that we will be able to implement and continue to maintain adequate measures to rectify or mitigate any such deficiencies in our internal controls.

46. *Our Promoters will continue to retain a large shareholding in us after the Offer, which will allow them to exercise significant influence over us.*

After the completion of the Offer, our Promoters will hold approximately [●]% of our outstanding Equity Shares. Accordingly, our Promoters will continue to exercise significant influence over our business and all matters requiring Shareholders’ approval, including the composition of our Board of Directors, the adoption of amendments to our constitutional documents, the approval of mergers, strategic acquisitions or joint ventures or the sales of substantially all of our assets, and the policies for dividends, investments and capital expenditures. This fraction of ownership may

also delay, defer or even prevent a change in control of our Company and may make some transactions more difficult or impossible without the support of our Promoters. Further, the Promoters' shareholding may limit the ability of a third party to acquire control. The interests of our Promoters, as our Company's controlling Shareholders, could conflict with our Company's interests, prospective investors' interests or the interests of our other Shareholders. There is no assurance that our Promoters will act to resolve any conflicts of interest in our Company's or your favour.

47. ***We entered into related party transactions aggregating to ₹ 64.10 million, ₹ 94.62 million and ₹ 236.73 million for Fiscals 2021, 2020 and 2019, respectively. We will continue to enter into such transactions and there can be no assurance that we could not have achieved more favourable terms had such transactions not been entered into with related parties.***

We have entered into transactions with several related parties, including our Promoters, aggregating to ₹ 64.10 million, ₹ 94.62 million and ₹ 236.73 million, on a consolidated basis, respectively, including in relation to expenses for the IPO, for Fiscals 2021, 2020 and 2019. For further details, see "Offer Document Summary - Summary of related party transactions" and, "Financial Statements – Notes to the Restated Consolidated Financial Statements – Note 41" on pages 15 and 261 respectively. While we believe that all such transactions have been conducted on an arms-length basis, there can be no assurance that we could not have achieved more favourable terms had such transactions not been entered into with related parties. Furthermore, it is likely that we will continue to enter into related party transactions in the future. While in terms of the Companies Act, 2013 and the SEBI Listing Regulations, certain related party transactions require Board (audit committee) and Shareholders' approval, there can be no assurance that these or any future related party transactions that we may enter into, individually or in the aggregate, will not have an adverse effect on our business and results of operations.

48. ***Our Directors or Promoters may enter into ventures that may lead to real or potential conflicts of interest with our business.***

Our Directors and Promoters may become involved in ventures that may potentially compete with our Company. The interests of our Directors and Promoters may conflict with the interests of our other Shareholders, and our Directors or Promoters may, for business considerations or otherwise, cause our Company to take actions, or refrain from taking actions, in order to benefit their interests instead of our Company's interests or the interests of its other Shareholders.

While our Directors and Promoters do not, as of the date of this Red Herring Prospectus, engage in any other business activities similar to our business lines, and have not undertaken any business in conflict with our Company, we cannot assure you that such a conflict will not arise in the future, or that we will be able to suitably resolve any such conflict without an adverse effect on our business or operations. In addition, while our Company has entered into the Waiver and Termination Agreement amending the Shareholders' Agreement, pursuant to which parties have agreed that the non-compete and non-solicit obligations of the Promoters under the Shareholders' Agreement will continue for a period of 24 months up to a date which is the earlier of: (i) the termination of the Shareholders' Agreement, or (ii) the Promoters executing a non-compete and non-solicit undertaking in a form acceptable to our Company, or executing an amendment to their respective employment agreements, in a form acceptable to our Company, to include such non-compete and non-solicit obligations after consummation of the Offer, we cannot assure you that our Directors or Promoters will not provide comparable services, solicit our employees or acquire interests in competing ventures in the locations, verticals or sectors in which we operate, which could have an adverse effect on our business and results of operations.

49. ***Any realisation of our contingent liabilities may adversely affect our financial condition, results of operations and cash flows.***

As of March 31, 2021, our Restated Consolidated Financial Information disclosed and reflected the following contingent liabilities:

<i>(₹ in million)</i>	
Particulars	As at March 31, 2021
Excise duty, entry tax and service tax matters	80.35
Income tax matters	11.98
Total	92.33

If any of these contingent liabilities materialise or if at any time we are compelled to pay all or a material proportion of these contingent liabilities, it may have an adverse effect on our financial condition, results of operations and cash flows. Furthermore, there can be no assurance that we will not incur contingent liabilities in future.

50. ***Some of our business operations are being conducted on leased premises. If we are unable to renew or extend such leases, our business operations may be adversely affected. In addition, some of our business operations are being conducted on premises that require the prior consent of certain state specific development authorities for the purpose of a change in the constitution of our Company, which could limit our Company's flexibility in running its business if it is unable to obtain the consent from such authorities for any desired changes to the constitution.***

Some of our business operations are being conducted on premises leased from third parties. The tenure of the leases is generally agreed in the relevant lease agreements and subject to renewal after the agreed period of time. While there are currently no instances of non-compliance of the terms of our lease agreements, there can be no assurance that there will be no such non-compliance leading to termination of such leases in the future. Any change in the terms and conditions of the lease agreements and any premature termination of such lease agreements may have an adverse effect on our operations.

Any adverse effect on the title, ownership rights, development rights of the owners from whose premises we operate, breach of the contractual terms of any lease, leave and license agreements, or any inability to renew such agreements on acceptable terms may also affect our operations. In addition, the terms of certain of our leases require us to obtain the lessor's prior consent for certain actions, including making structural alterations to the leased premises, which may be required if we were to undertake an expansion in the future.

There can be no assurance that we will be able to renew these leasing arrangements at commercially favourable terms, or at all. If we are unable to renew all or any of our leasing arrangements, it may cause disruptions in our business and we may incur substantial costs associated with shifting to new premises, all of which may adversely affect our business operations. Further, some of our lease agreements may not be adequately stamped or duly registered which may render them inadmissible as evidence in legal proceedings and impact our ability to enforce these agreements or attract penalty. This may adversely impact the continuance of our operations and business.

Some of our business operations are being conducted on premises leased from state specific development authorities. The lease and sale agreements entered into with the KIADB and the Haryana State Industrial and Infrastructure Development Corporation (“**HSIIDC**”) in relation to two of our manufacturing facilities situated in Bidadi, Karnataka and Manesar, Haryana, respectively, require our Company to seek their prior consent for any change in the constitution of our Company, which could limit our Company's flexibility in running its business if it is unable to obtain the consent from such authorities for any desired changes to the constitution. Our Company changed its constitution when it converted from a private limited company to a public limited company. While our Company made the necessary applications to the KIADB and HSIIDC pursuant to letters dated July 3, 2018 and July 9, 2018, respectively, seeking a no objection for the conversion of our Company from a private limited company to a public limited company, and a waiver for post facto approval for the changes, our Company is yet to receive a response to the same. There is no assurance that we will receive the consents and if we do not, KIADB and HSIIDC may seek to terminate the lease agreements. If a lease agreement is terminated, we would need to relocate the manufacturing undertaken on the land to a different location, which would involve additional costs and which could have an adverse effect on our business, financial condition, results of operations and cash flows.

51. *Information relating to the installed capacity and capacity utilisation included in this Red Herring Prospectus is based on various assumptions and estimates and capacity utilisation may vary.*

Information relating to the installed capacity and capacity utilisation included in this Red Herring Prospectus are based on various assumptions and estimates of our management that have been taken into account by the chartered engineer in the calculation of our installed capacity and capacity utilisation. Future capacity utilisation rates may vary significantly from the estimated production capacities of our manufacturing facilities and historical capacity utilisation rates. In addition, capacity utilisation is calculated differently in different countries, industries and for the different kinds of products we manufacture. Undue reliance should therefore not be placed on our historical installed capacity and capacity utilisation for our existing manufacturing facilities included in this Red Herring Prospectus. See “*Our Business – Installed Capacity and Capacity Utilisation by Product Family*” on page 164.

52. *We cannot assure payment of dividends on the Equity Shares in the future.*

Our ability to pay dividends in the future will depend on our earnings, financial condition, cash flows, capital requirements, capital expenditure and restrictive covenants of our financing arrangements. Any future determination as to the declaration and payment of dividends will be at the discretion of our Board of Directors and subsequent approval of Shareholders and will depend on factors that our Board of Directors and Shareholders deem relevant, including among others, our future earnings, financial condition, cash flows, capital requirements, capital expenditures, business prospects and restrictive covenants under our financing arrangements. We may decide to retain all of our earnings to finance the development and expansion of our business and, therefore, may not declare dividends on the Equity Shares. We cannot assure you that we will be able to pay dividends at any point in the future. For further information, see “*Dividend Policy*” on page 218.

53. *The requirements of being a publicly listed company may strain our resources.*

We are not a publicly listed company and have not, historically, been subjected to the increased scrutiny of our affairs by shareholders, regulators and the public at large that is associated with being a listed company. As a listed company, we will incur significant legal, accounting, corporate governance and other expenses that we did not incur as an unlisted company. We will be subject to the SEBI Listing Regulations, which will require us to file audited annual and unaudited

quarterly reports with respect to our business and financial condition. If we experience any delays, we may fail to satisfy our reporting obligations and/or we may not be able to readily determine and accordingly report any changes in our results of operations as promptly as other listed companies.

Further, as a publicly listed company, we will need to maintain and improve the effectiveness of our disclosure controls and procedures and internal control over financial reporting, including keeping adequate records of daily transactions. In order to maintain and improve the effectiveness of our disclosure controls and procedures and internal control over financial reporting, significant resources and management attention will be required. As a result, our management's attention may be diverted from our business concerns, which may adversely affect our business, prospects, results of operations and financial condition. In addition, we may need to hire additional legal and accounting staff with appropriate experience and technical accounting knowledge, but we cannot assure you that we will be able to do so in a timely and efficient manner.

54. *Sansera Sweden, our Company's indirect subsidiary, has availed an unsecured loan from Sansera Mauritius, our Company's direct subsidiary, which can be recalled at any time.*

Sansera Sweden, our Company's indirect subsidiary, has availed an unsecured loan from Sansera Mauritius, our Company's direct subsidiary. The balance of such loan and interest as on March 31, 2021 was EUR 1.65 million. This loan is repayable on demand. In the event Sansera Mauritius demands repayment of the loan, Sansera Sweden would need to find alternative sources of financing, which may not be available on commercially reasonable terms, or at all. The loan from Sansera Mauritius to Sansera Sweden, being an intra-Group loan, is eliminated on the consolidation of our financial statements.

EXTERNAL RISK FACTORS

55. *Any downturn in the macroeconomic environment in India would adversely affect our business, financial condition, results of operations and cash flows.*

For Fiscals 2021, 2020 and 2019, 64.98%, 69.38% and 69.00% of our revenue from sale of products, respectively, was from customers in India. Therefore, any downturn in the macroeconomic environment in India could adversely affect our business, financial condition, results of operations and cash flows. The Indian economy could be adversely affected by various factors, such as the impact of COVID-19 pandemic or other pandemics, epidemics, political and regulatory changes, including adverse changes in the Government's liberalisation policies, social disturbances, religious or communal tensions, terrorist attacks and other acts of violence or war, natural calamities, volatility in interest rates, volatility in commodity and energy prices, a loss of investor confidence in other emerging market economies and any worldwide financial instability. In addition, an increase in India's trade deficit, a downgrading in India's sovereign debt rating or a decline in India's foreign exchange reserves could increase interest rates and adversely affect liquidity, which could adversely affect the Indian economy and thereby adversely affect our business, financial condition, results of operations and cash flows.

Also see “ – *The COVID-19 pandemic has had, and we expect it to continue to have, a material adverse effect on our business, financial condition, results of operations and cash flows*” on page 22.

56. *Financial instability in other countries may cause increased volatility in Indian financial markets and, directly or indirectly, adversely affect the Indian economy and our business, financial condition, results of operations and cash flows.*

The Indian financial markets and the Indian economy are influenced by economic and market conditions in other countries, including conditions in the United States, Europe and emerging economies in Asia. Financial instability in other parts of the world could have a global influence and thereby negatively affect the Indian financial markets. Although economic conditions vary across markets, a loss of investor confidence in one emerging market may cause increased volatility in other emerging markets, including the Indian financial markets. Therefore, financial instability in other countries may cause increased volatility in Indian financial markets and, directly or indirectly, have an adverse effect on the Indian economy and our business, financial condition, results of operations and cash flows.

57. *Our business and activities may be regulated by the Competition Act, 2002.*

The Competition Act, 2002, as amended (the “**Competition Act**”), was enacted for the purpose of preventing practices having an adverse effect on competition in India and has mandated the Competition Commission of India (the “**CCI**”) to regulate such practices. Under the Competition Act, any arrangement, understanding or action, whether formal or informal, which causes or is likely to cause an appreciable adverse effect on competition in India is void and may result in substantial penalties. Any agreement among competitors which directly or indirectly determines purchase or sale prices, directly or indirectly results in bid rigging or collusive bidding, limits or controls production, supply, markets, technical development, investment or the provision of services, or shares the market or source of production or provision of services in any manner, including by way of allocation of geographical area or types of goods or services or number

of customers in the relevant market or any other similar way, is presumed to have an appreciable adverse effect on competition in the relevant market in India and shall be void. The Competition Act also prohibits the abuse of dominant position by any enterprise. If it is demonstrated that any contravention committed by a company took place with the consent or connivance or is attributable to any neglect on the part of, any director, manager, secretary or other officer of such company, that person shall be guilty of the contravention and may be punished.

On March 4, 2011, the Government notified and brought into force the combination regulation (merger control) provisions under the Competition Act with effect from June 1, 2011. These provisions require acquisitions of shares, voting rights, assets or control or mergers or amalgamations that cross the prescribed asset and turnover based thresholds to be mandatorily notified to and pre-approved by the CCI. Additionally, on May 11, 2011, the CCI issued the Competition Commission of India (Procedure in regard to the transaction of business relating to combinations) Regulations 2011, as amended, which sets out the mechanism for implementation of the merger control regime in India. Consequently, all agreements entered into by us may fall within the purview of the Competition Act.

Further, the CCI has extraterritorial powers and can investigate any agreements, abusive conduct or combination occurring outside India if such agreement, conduct or combination has an appreciable adverse effect on competition in India. However, we cannot predict the impact of the provisions of the Competition Act on the agreements entered into by us at this stage. We are not currently party to any outstanding proceedings, nor have we received notice in relation to non-compliance with the Competition Act or the agreements entered into by us. However, if we are affected, directly or indirectly, by the application or interpretation of any provision of the Competition Act, or any enforcement proceedings initiated by the CCI, or any adverse publicity that may be generated due to scrutiny or prosecution by the CCI or if any prohibition or substantial penalties are levied under the Competition Act, it would adversely affect our business, financial condition, results of operations and cash flows.

58. *Political instability, changes in economic policy, changing laws, rules and regulations and legal uncertainties, including adverse application of tax laws and regulations, may adversely affect our business, financial condition and results of operations.*

Any political instability in India, such as corruption, scandals and protests against certain economic reforms, which have occurred in the past, could slow the pace of liberalisation and deregulation. The rate of economic liberalisation could change, and specific laws and policies affecting foreign investment, currency exchange rates and other matters affecting investment in India could change as well.

Our business and financial performance could be adversely affected by unfavourable changes in or interpretations of existing, or the promulgation of new, laws, rules and regulations applicable to us and our business. For further details of the laws currently applicable to us, see “*Key Regulations and Policies*” on page 184.

There can be no assurance that the Government of India will not implement new regulations and policies that would require us to obtain approvals and licences from the Government of India and other regulatory bodies, or impose onerous requirements and conditions on our operations. Any such changes and the related uncertainties with respect to the applicability, interpretation and implementation of any amendment or change to governing laws, regulation or policy in the jurisdictions in which we operate may have a material adverse effect on our business, financial condition and results of operations. In addition, we may have to incur expenditures to comply with the requirements of any new regulations, which may also materially harm our results of operations. Any unfavourable changes to the laws and regulations applicable to us could also subject us to additional liabilities.

In addition, unfavourable changes in, or interpretations of, (or the promulgation of) existing or new laws, rules and regulations including foreign investment laws governing our business, operations and group structure could result in us being deemed to be in contravention of such laws or may require us to apply for additional approvals. We may incur increased costs relating to compliance with such new requirements, which may require management time and other resources, and any failure to comply may adversely affect our business and results of operations. Uncertainty in the applicability, interpretation or implementation of any amendment to, or changes in, governing laws, regulations or policies, including by reason of an absence, or a limited body, of administrative or judicial precedent may be time-consuming and costly for us to resolve and may affect the viability of our current business or restrict our ability to grow our business in the future.

The application of various Indian tax laws, rules and regulations to our business, currently or in the future, is subject to interpretation by the applicable taxation authorities. If such tax laws, rules and regulations are amended, new adverse laws, rules or regulations are adopted or current laws are interpreted adversely to our interests, it could increase our tax payments (prospectively or retrospectively) and/ or subject us to penalties. As a result, any such changes or interpretations could have an adverse effect on our business, financial condition and results of operations.

59. *Terrorist attacks, civil disturbances and regional conflicts involving India may have an adverse effect on our business, results of operations and the price of the Equity Shares.*

India has, from time to time, experienced social and civil unrest within the country and hostilities with neighbouring countries. There have been continuing tensions between India and Pakistan over the states of Jammu and Kashmir. In the past there were armed conflicts over parts of Kashmir. Isolated troop conflicts and terrorist attacks continue to take place in these regions. In addition, in June 2020, a confrontation occurred between Indian and Chinese military forces. These hostilities and tensions could lead to political or economic instability in India, which may have an adverse effect on our business, results of operations and the price of the Equity Shares. In addition, any further hostilities and tensions could result in investors attaching a higher risk premium to shares of Indian companies, which could have an adverse effect on the price of the Equity Shares.

India has witnessed localized terrorist attacks in the recent past, including, among others, the terrorist attacks in Pulwama in 2019, in Pathankot and Uri in 2016, in Mumbai in 2011 and 2008 and in New Delhi in 2011. Any further terrorist attack in India could result in investors attaching a higher risk premium to shares of Indian companies, which could have an adverse effect on the price of the Equity Shares.

60. *Any downgrading of India's sovereign debt rating by an international rating agency may adversely affect our ratings and thereby the terms on which we are able to borrow on.*

Various international rating agencies rate India's sovereign debt. For instance, India's sovereign debt is currently rated "BBB-", outlook negative by Fitch Ratings. Any adverse revisions to India's sovereign debt ratings by international rating agencies may adversely affect our ratings and thereby the terms on which we are able to borrow on. This could have an adverse effect on our financial condition, results of operations and cash flows.

61. *If inflation rises in India, increased costs may result in a decrease in our profits.*

Increasing inflation in India could cause the costs of rent, wages, raw materials and other expenses to rise. If we are unable to increase our revenues sufficiently to offset our increased costs due to inflation, it could have an adverse effect on our business, financial condition, results of operations and cash flows.

62. *The occurrence of natural disasters may adversely affect our business, financial condition, results of operations and cash flows.*

The occurrence of natural disasters, including hurricanes, floods, tsunamis, earthquakes, tornadoes, fires and explosions, could damage or destroy one or more of our manufacturing facilities and adversely affect our business, financial condition and results of operations. In addition, the COVID-19 pandemic has had, and we expect it to continue to have, an adverse effect on our business, financial condition, results of operations and cash flows. See "*The COVID-19 pandemic has had, and we expect it to continue to have, a material adverse effect on our business, financial condition, results of operations and cash flows*" on page 22. Another public health crisis in India, Sweden or in any country where we have a large customer, such as an outbreak the H5N1 "avian flu" virus, the H1N1 swine flu virus, Middle East Respiratory Syndrome (MERS) or Zika virus, could also have an adverse effect on our business, financial condition, results of operations and cash flows.

63. *Significant differences exist between Ind AS and other accounting principles, such as U.S. GAAP and IFRS, which investors outside India may be more familiar with and may consider material to their assessment of our financial condition, results of operations and cash flows.*

The Restated Consolidated Financial Information has been compiled by our Company's management from the audited consolidated financial statements as at and for each of the financial years ended March 31, 2021, 2020 and 2019. The above mentioned audited financial statements have been prepared in accordance with the requirements prescribed under Ind AS and the Companies Act, 2013. The Restated Consolidated Financial Information have been prepared in accordance with the requirements of section 26 of Part 1 of Chapter III of the Companies Act, the SEBI ICDR Regulations and the Guidance Note on Reports in Company Prospectuses (Revised 2019). Ind AS differs in certain significant respects from IFRS, U.S. GAAP and other accounting principles with which prospective investors outside India may be familiar. If the Restated Consolidated Financial Information were to be prepared in accordance with such other accounting principles, our financial condition, results of operations and cash flows may be substantially different. Prospective investors should review the accounting policies applied in the preparation of the Restated Consolidated Financial Information and consult their own professional advisers for an understanding of the differences between these accounting principles and those with which they may be more familiar. Any reliance by persons unfamiliar with Ind AS on the financial information presented in the Red Herring Prospectus should accordingly be limited.

64. *It may not be possible for investors to enforce any judgment obtained outside India against our Company, the Directors or the Key Managerial Personnel in India except by way of a lawsuit in India.*

Our Company is incorporated under the laws of India, the majority of our assets are located in India and all but one of our Directors and all of the Key Managerial Personnel are residents of India. The enforcement of civil liabilities by overseas investors in the Equity Shares, including the ability to effect service of process and to enforce judgments obtained in courts outside of India may be adversely affected by the fact that our Company is incorporated under the laws of India and all but one of our Directors and all of the Key Managerial Personnel reside in India. As a result, it may be difficult to enforce the service of process upon our Company and any of these persons outside of India or to enforce outside of India, judgments obtained against our Company and these persons in courts outside of India.

India is not a party to any international treaty in relation to the recognition or enforcement of foreign judgments. Recognition and enforcement of foreign judgments is provided for under Section 13, 14 and Section 44A of the Code of Civil Procedure, 1908 (“**Civil Code**”) on a statutory basis. Section 44A of the Civil Code provides that where a certified copy of a decree of any superior court, within the meaning of that Section, obtained in any country or territory outside India which the government has by notification declared to be in a reciprocating territory, may be enforced in India by proceedings in execution as if the judgment had been rendered by a district court in India. However, Section 44A of the Civil Code is applicable only to monetary decrees and does not apply to decrees for amounts payable in respect of taxes, other charges of a like nature or in respect of a fine or other penalties and does not apply to arbitration awards (even if such awards are enforceable as a decree or judgment).

The United Kingdom, Singapore and Hong Kong, among others, have been declared by the Government to be reciprocating territories for the purposes of Section 44A of the Civil Code. The United States has not been declared by the Government of India to be a reciprocating territory for the purposes of Section 44A of the Civil Code. A judgment of a court of a country which is not a reciprocating territory may be enforced in India only by a suit upon the judgment under Section 13 of the Civil Code, and not by proceedings in execution. Section 13 of the Civil Code provides that foreign judgments shall be conclusive regarding any matter directly adjudicated upon except: (i) where the judgment has not been pronounced by a court of competent jurisdiction; (ii) where the judgment has not been given on the merits of the case; (iii) where it appears on the face of the proceedings that the judgment is founded on an incorrect view of international law or refusal to recognize the law of India in cases to which such law is applicable; (iv) where the proceedings in which the judgment was obtained were opposed to natural justice; (v) where the judgment has been obtained by fraud; and/ or (vi) where the judgment sustains a claim founded on a breach of any law then in force in India. The suit must be brought in India within three years from the date of judgment in the same manner as any other suit filed to enforce a civil liability in India.

Further, there are considerable delays in the disposal of suits by Indian courts. It may be unlikely that a court in India would award damages on the same basis as a foreign court if an action is brought in India. Furthermore, it may be unlikely that an Indian court would enforce foreign judgments if it viewed the amount of damages awarded as excessive or inconsistent with public policy in India. A party seeking to enforce a foreign judgment in India is required to obtain prior approval from the RBI under FEMA to repatriate any amount recovered pursuant to execution and any such amount may be subject to income tax in accordance with applicable laws. Any judgment or award in a foreign currency would be converted into Indian Rupees on the date of the judgment or award and not on the date of the payment.

65. *Rights of shareholders under Indian laws may be more limited than under the laws of other jurisdictions.*

Indian legal principles related to corporate procedures, directors’ fiduciary duties and liabilities, and shareholders’ rights may differ from those that would apply to a company in another jurisdiction. Shareholders’ rights including in relation to class actions, under Indian law may not be as extensive as shareholders’ rights under the laws of other countries or jurisdictions. Investors may have more difficulty in asserting their rights as shareholder in an Indian company than as shareholder of a corporation in another jurisdiction. Further, our Company’s Articles of Association, composition of our Company’s Board, Indian laws governing our corporate affairs, the validity of corporate procedures, directors’ fiduciary duties, responsibilities and liabilities, and shareholders’ rights may differ from those that would apply to a company in another jurisdiction. Shareholders’ rights under Indian law may not be as extensive and widespread as shareholders’ rights under the laws of other countries or jurisdictions. Investors may face challenges in asserting their rights as a shareholder in an Indian company than as a shareholder of an entity in another country or jurisdiction.

66. *A third party could be prevented from acquiring control over our Company because of anti-takeover provisions under Indian law.*

There are provisions in Indian law that may delay, deter or prevent a future takeover or change in control of our Company. These provisions may discourage or prevent certain types of transactions involving actual or threatened change in control of us. Under the Takeover Regulations, an acquirer has been defined as any person who, directly or indirectly, acquires or agrees to acquire shares or voting rights or control over a company, whether individually or acting in concert with others. Although these provisions have been formulated to ensure that interests of investors/shareholders are protected, these provisions may also discourage a third party from attempting to take control of our Company.

Consequently, even if a potential takeover of our Company would result in the purchase of the Equity Shares at a premium to their market price or would otherwise be beneficial to our Shareholders, such a takeover may not be attempted or consummated because of the regulatory framework applicable to us.

67. *Foreign investors are subject to investment restrictions under Indian law that limit our ability to attract foreign investors, which may adversely affect the trading price of the Equity Shares.*

Under foreign exchange regulations currently in force in India, transfer of shares between non-residents and residents are freely permitted (subject to certain restrictions), if they comply with the valuation and reporting requirements specified under applicable law. If a transfer of shares is not in compliance with such requirements and does not fall under any of the exceptions, then prior approval of the relevant regulatory authority is required. Additionally, shareholders who seek to convert Rupee proceeds from a sale of shares in India into foreign currency and repatriate that foreign currency from India require a no-objection or a tax clearance certificate from the Indian income tax authorities. Further, this conversion is subject to the shares having been held on a repatriation basis and, either the security having been sold in compliance with the pricing guidelines or, the relevant regulatory approval having been obtained for the sale of shares and corresponding remittance of the sale proceeds. We cannot assure you that any required approval from the RBI or any other governmental agency can be obtained with or without any particular terms or conditions.

Further, in accordance with Press Note No. 3 (2020 Series), dated April 17, 2020, issued by the Department for Promotion of Industry and Internal Trade, Government of India, and the Foreign Exchange Management (Non-debt Instruments) Amendment Rules, 2020, which came into effect from April 22, 2020, investments where the beneficial owner of the Equity Shares is situated in or is a citizen of a country which shares land border with India, can only be made through the Government approval route, as prescribed in the FDI Policy. These investment restrictions shall also apply to subscribers of offshore derivative instruments. We cannot assure you that any required approval from the RBI or any other governmental agency can be obtained on any particular terms or at all. For further information, see “*Restrictions on Foreign Ownership of Indian Securities*” on page 358. Our ability to raise foreign capital under the FDI route is therefore constrained by Indian law, which may adversely affect our business, financial condition, results of operations and cash flows.

RISKS RELATING TO THE OFFER AND THE EQUITY SHARES

68. *The determination of the Price Band is based on various factors and assumptions and the Offer Price of the Equity Shares may not be indicative of the market price of the Equity Shares after the Offer. Further, the current market price of some securities listed pursuant to certain previous issues managed by the BRLMs is below their respective issue prices.*

The determination of the Price Band is based on various factors and assumptions and will be determined by our Company and the Investor Selling Shareholders in consultation with the BRLMs and the Promoter Selling Shareholders. Furthermore, the Offer Price of the Equity Shares will be determined by our Company in consultation with the BRLMs and the Selling Shareholders through the Book Building Process. These will be based on numerous factors, including the factors described in “*Basis for Offer Price*” on page 86 and may not be indicative of the market price for the Equity Shares after the Offer. Further, the BRLMs have previously handled issues wherein the market price of the issued shares declined below the offer/issue price of shares within 30 days of their listing and in certain cases continued to trade at a price lower than their offer/issue price on the 180th day from listing. For details of the price information of the past issues handled by the BRLMs, see “*Other Regulatory and Statutory Disclosures*” on page 324.

The market price of the Equity Shares may fluctuate as a result of, among other things, the following factors, some of which are beyond our control:

- quarterly variations in our results of operations;
- results of operations that vary from those of our competitors;
- changes in expectations as to our future financial performance, including financial estimates by research analysts and investors;
- a change in research analysts’ recommendations;
- announcements by us or our competitors of significant acquisitions, strategic alliances, joint operations or capital commitments;
- announcements by third parties or governmental entities of significant claims or proceedings against us;
- new laws and governmental regulations applicable to our industry;

- additions or departures of key managerial personnel;
- changes in exchange rates;
- changes in the price of conventional and renewable energy;
- fluctuations in stock market prices and volume; and
- general economic and stock market conditions.

Changes in relation to any of the factors listed above could adversely affect the price of the Equity Shares. The market price of the Equity Shares may decline below the Offer Price and investors may not be able to resell Equity Shares at or above the Offer Price resulting in a loss of all or part of the investment.

69. *Investors will not be able to sell immediately on an Indian stock exchange any of the Equity Shares they purchase in the Offer.*

The Equity Shares will be listed on the Stock Exchanges. Pursuant to applicable Indian laws, certain actions must be completed before the Equity Shares can be listed and trading in the Equity Shares may commence. The Allotment of Equity Shares in this Offer and the credit of such Equity Shares to the applicant's demat account with depository participant could take approximately six Working Days from the Bid Closing Date and trading in the Equity Shares upon receipt of final listing and trading approvals from the Stock Exchanges is expected to commence within six Working Days of the Bid Closing Date. There could be a failure or delay in listing of the Equity Shares on the Stock Exchanges. Any failure or delay in obtaining the approval or otherwise any delay in commencing trading in the Equity Shares would restrict investors' ability to dispose their Equity Shares. There can be no assurance that the Equity Shares will be credited to investors' demat accounts, or that trading in the Equity Shares will commence, within the time periods specified in this risk factor. We could also be required to pay interest at the applicable rates if allotment is not made, refund orders are not dispatched or demat credits are not made to investors within the prescribed time periods.

70. *Investors may be subject to Indian taxes arising out of the sale of the Equity Shares.*

Under current Indian tax laws, unless specifically exempted, capital gains arising from the sale of equity shares held as investments in an Indian company are generally taxable in India. Any capital gain realised on the sale of listed equity shares on a Stock Exchange held for more than 12 months immediately preceding the date of transfer will be subject to long term capital gains in India at the specified rates depending on certain factors, such as whether the sale is undertaken on or off the Stock Exchanges, the quantum of gains and any available treaty relief. Accordingly, you may be subject to payment of long-term capital gains tax in India, in addition to payment of Securities Transaction Tax ("STT"), on the sale of any Equity Shares held for more than 12 months immediately preceding the date of transfer. STT will be levied on the seller and/or the purchaser of the Equity Shares and collected by the domestic stock exchange on which the Equity Shares are sold. Further, any capital gains realised on the sale of listed equity shares held for a period of 12 months or less immediately preceding the date of transfer will be subject to short term capital gains tax in India as well as STT.

Capital gains arising from the sale of the Equity Shares will not be chargeable to tax in India in cases where relief from such taxation in India is provided under a treaty between India and the country of which the seller is resident read with the Multilateral Instrument (MLI), if and to the extent applicable, and the seller is entitled to avail benefits thereunder. Generally, Indian tax treaties do not limit India's ability to impose tax on capital gains. As a result, residents of other countries may be liable for tax in India as well as in their own jurisdiction on a gain upon the sale of the Equity Shares.

No dividend distribution tax is required to be paid in respect of dividends declared, distributed or paid by a domestic company after March 31, 2020 and, accordingly, such dividends would not be exempt in the hands of the shareholders, both for residents as well as non-residents. The Company may or may not grant the benefit of a tax treaty (where applicable) to a non-resident shareholder for the purposes of deducting tax at source pursuant to any corporate action, including dividends.

Similarly, any business income realised from the transfer of equity shares held as trading assets is taxable at the applicable tax rates subject to any treaty relief, if applicable, to a non-resident seller. Additionally, in terms of the Finance Act, 2018, which has been notified on March 29, 2018 with effect from April 1, 2018, taxes payable by an assessee on the capital gains arising from transfer of long-term capital assets (introduced as section 112A of the Income-Tax Act, 1961) shall be calculated on such long-term capital gains at the rate of 10%, where the long-term capital gains exceed ₹ 100,000, subject to certain exceptions in case of resident individuals and Hindu Undivided Families.

Further, the Finance Act, 2019 has made various amendments in the taxation laws and clarified that, in the absence of a specific provision under an agreement, the buyer will be liable to pay stamp duty in case of sale of securities through stock exchanges, while in other cases of transfer for consideration through a depository, the onus will be on the transferor. The stamp duty for transfer of securities other than debentures, on a delivery basis, is specified at 0.015%

and on a non-delivery basis is specified at 0.003% of the consideration amount. These amendments were notified on December 10, 2019 and have come into effect from July 1, 2020.

71. *Any future issuance of Equity Shares may dilute your shareholdings and sales of the Equity Shares by our Shareholders may adversely affect the trading price of the Equity Shares.*

We may be required to finance our growth through future equity offerings. Any future equity issuances by our Company, including a primary offering, may lead to the dilution of investors' shareholdings in our Company. Any future issuances of Equity Shares or the disposal of Equity Shares by our Shareholders or the perception that such issuance or sale may occur, may adversely affect the trading price of the Equity Shares, which may lead to other adverse consequences including difficulty in raising capital through offering of the Equity Shares or incurring additional debt. Any future issuances could also dilute the value of your investment in the Equity Shares. In addition, any perception by investors that such issuances or sales might occur may also affect the market price of the Equity Shares.

72. *Holders of Equity Shares may be restricted in their ability to exercise pre-emptive rights under Indian law and thereby may suffer future dilution of their ownership position.*

Under the Companies Act, 2013, a company incorporated in India must offer holders of its equity shares pre-emptive rights to subscribe and pay for a proportionate number of shares to maintain their existing ownership percentages prior to the issuance of any new equity shares, unless the pre-emptive rights have been waived by the adoption of a special resolution by holders of three-fourths of the equity shares who have voted on such resolution. However, if the law of the jurisdiction that you are in does not permit the exercise of such pre-emptive rights without our Company filing an offering document or registration statement with the applicable authority in such jurisdiction, you will be unable to exercise such pre-emptive rights unless our Company makes such a filing. Our Company may elect not to file a registration statement in relation to pre-emptive rights otherwise available by Indian law to you. To the extent that you are unable to exercise pre-emptive rights granted in respect of the Equity Shares, you may suffer future dilution of your ownership position and your proportional interests in our Company would be reduced.

73. *Fluctuations in the exchange rate between the Rupee and other currencies could have an adverse effect on the value of the Equity Shares in those currencies, independent of our results of operations.*

The Equity Shares will be quoted in Rupees on the Stock Exchanges. Any dividends in respect of the Equity Shares will be paid in Rupees. Any adverse movement in currency exchange rates during the time it takes to undertake such conversion may reduce the net dividend received by investors. In addition, any adverse movement in currency exchange rates during a delay in repatriating the proceeds from a sale of Equity Shares outside India, for example, because of a delay in regulatory approvals that may be required for the sale of Equity Shares, may reduce the net proceeds received by investors. The exchange rate between the Rupee and other currencies (such as the U.S. dollar, the Euro, the pound sterling, the Hong Kong dollar and the Singapore dollar) has changed substantially in the past and could fluctuate substantially in the future, which may have an adverse effect on the value of the Equity Shares and returns from the Equity Shares in foreign currency terms, independent of our results of operations.

74. *QIBs and Non-Institutional Investors are not permitted to withdraw or lower their Bids (in terms of quantity of Equity Shares or the Bid Amount) at any stage after submitting a Bid.*

Pursuant to the SEBI ICDR Regulations, QIBs and Non-Institutional Investors are not permitted to withdraw or lower their Bids (in terms of quantity of Equity Shares or the Bid Amount) at any stage after submitting a Bid. Retail Individual Investors can revise their Bids during the Bid/ Offer Period and withdraw their Bids until Bid/ Offer Closing Date. While our Company is required to complete Allotment pursuant to the Offer within six Working Days from the Bid/ Offer Closing Date, events affecting the Bidders' decision to invest in the Equity Shares, including material adverse changes in international or national monetary policy, financial, political or economic conditions, our business, financial condition or results of operations may arise between the date of submission of the Bid and Allotment. Our Company may complete the Allotment of the Equity Shares even if such events occur, and such events limit the Bidders' ability to sell the Equity Shares Allotted pursuant to the Offer or cause the trading price of the Equity Shares to decline on listing.

75. *Our Company shall not receive the proceeds from the Offer.*

The Offer comprises an offer for sale of 17,244,328 Equity Shares by the Selling Shareholders. The entire proceeds after deducting relevant Offer expenses from the proceeds from the Offer for Sale will be paid to the Selling Shareholders and our Company will not receive any such proceeds. For further details, see "The Offer" and "Objects of the Offer" on pages 54 and 84, respectively.

76. *Statistical and industry data in this Red Herring Prospectus are derived from the CRISIL Report and the Ricardo Report, both of which were commissioned by our Company for the purpose of the Offer for an agreed fee. Each of the CRISIL Report and the Ricardo Report is not exhaustive and is based on certain assumptions, parameters and conditions. The data and statistics in the CRISIL Report and the Ricardo Report may be inaccurate, incomplete or*

unreliable.

This Red Herring Prospectus includes information that is derived from the CRISIL Report, which was prepared by CRISIL Research pursuant to an engagement with our Company. CRISIL Research is not in any manner related to our Company, our Directors or our Promoters. This Red Herring Prospectus also includes information that is derived from the Ricardo Report, which was prepared by Ricardo pursuant to an engagement with our Company. Ricardo is not in any manner related to our Company, our Directors or our Promoters.

Each of the CRISIL Report and the Ricardo Report is subject to various limitations and based upon certain assumptions that are subjective in nature. While our Company, the Selling Shareholders and the BRLMs have no reason to believe the data and statistics in the CRISIL Report and the Ricardo Report are incorrect, our Company, the Selling Shareholders and the BRLMs cannot assure you that they are accurate, complete or reliable and, therefore, our Company, the Selling Shareholders and the BRLMs make no representation or warranty, express or implied, as to the accuracy, completeness or reliability of such data or statistics. Therefore, discussions of matters relating to India, its economy, the global economy and the industry in which we operate are subject to the caveat that data and statistics upon which such discussions are based may be inaccurate, incomplete or unreliable. Further, there can be no assurance that such data and statistics are stated or compiled on the same basis or with the same degree of accuracy as may be the case in other reports. Statements from third parties that involve estimates are subject to change, and actual amounts may differ materially from those included in this Red Herring Prospectus. Industry sources and publications are also prepared based on information as of specific dates and may no longer be current or reflect current trends. Industry sources and publications may also base their information on estimates, projections, forecasts and assumptions that may prove to be incorrect. In view of the foregoing, investors may not be able to seek legal recourse for any losses resulting from undertaking any investment in the Offer pursuant to reliance on the information in this Red Herring Prospectus based on, or derived from, the CRISIL Report or the Ricardo Report. Accordingly, potential investors should not place undue reliance on, or base their investment decision solely on this information. For further details, see “*Industry Overview*” on page 94.

77. ***We have included certain non-GAAP financial measures and certain other selected statistical information related to our business, financial condition, results of operations and cash flows in this Red Herring Prospectus. These non-GAAP financial measures and statistical information may vary from any standard methodology that is applicable across the manufacturing industry, and therefore may not be comparable with financial or statistical information of similar nomenclature computed and presented by other manufacturing companies.***

Certain non-GAAP financial measures and other statistical information relating to our business, financial condition, results of operation and cash flows have been included in this Red Herring Prospectus. For information on the non-GAAP financial measures, see “*Certain Conventions, Presentation of Financial, Industry and Market Data and Currency of Presentation – Non-GAAP Financial Measures*” and “*Management’s Discussion and Analysis of Financial Condition and Results of Operations – Key Performance Indicators and Certain Non-GAAP Measures*” on pages 18 and 288, respectively. We compute and disclose such non-GAAP financial measures and such other statistical information relating to our operations and financial performance as we consider such information to be useful measures of our business and financial performance, and because such measures are frequently used by securities analysts, investors and others to evaluate the operational performance of financial services businesses, many of which provide such non-GAAP financial measures and other statistical and operational information when reporting their financial results. Such non-GAAP measures are not measures of operating performance or liquidity defined by generally accepted accounting principles. These non-GAAP financial measures and other statistical and other information relating to our operations and financial performance may not be computed on the basis of any standard methodology that is applicable across the industry and therefore may not be comparable to financial measures and statistical information of similar nomenclature that may be computed and presented by other manufacturing companies.

SECTION III: INTRODUCTION

THE OFFER

The following table sets forth details of the Offer:

Equity Shares Offered	
Offer of Equity Shares⁽¹⁾	
<i>The Offer consists of:</i>	
Offer for Sale ⁽²⁾	Up to 17,244,328 Equity Shares, aggregating up to ₹[●] million
<i>of which:</i>	
Employee Reservation Portion ⁽³⁾	Up to [●] Equity Shares, aggregating up to ₹90 million
Net Offer	Up to [●] Equity Shares aggregating up to ₹[●] million
A) QIB Portion ⁽⁴⁾⁽⁵⁾	Not less than [●] Equity Shares
<i>of which:</i>	
- Anchor Investor Portion	Up to [●] Equity Shares
- Net QIB Portion (assuming the Anchor Investor Portion is fully subscribed)	[●] Equity Shares
<i>of which:</i>	
- Mutual Fund Portion	[●] Equity Shares
- Balance for all QIBs including Mutual Funds (5% of the QIB Category (excluding Anchor Investor Portion))	[●] Equity Shares
B) Non-Institutional Portion	Not less than [●] Equity Shares
C) Retail Portion ⁽⁶⁾	Not less than [●] Equity Shares
Pre and post-Offer Equity Shares	
Equity Shares outstanding prior to the Offer*	51,377,850 Equity Shares
Equity Shares outstanding after the Offer	51,377,850 Equity Shares
Use of Net Proceeds of the Offer	See “ <i>Objects of the Offer</i> ” on page 84 for information about the use of the proceeds from the Offer. Our Company will not receive any proceeds from the Offer for Sale.

*Number of Equity Shares outstanding as on the date of this Red Herring Prospectus, prior to exercise of vested employee stock options. For further details, see “Capital Structure” on page 68.

⁽¹⁾ The Offer has been authorised by our Board of Directors pursuant to the resolution passed at its meetings dated March 18, 2021 and by our Shareholders pursuant to the resolutions dated June 2, 2021. The DRHP had been approved by our Board pursuant to a resolution passed on June 9, 2021. This Red Herring Prospectus has been approved by our Board pursuant to a resolution on September 6, 2021

⁽²⁾ The Equity Shares being offered by the Selling Shareholders are eligible for being offered for sale pursuant to the Offer in terms of the SEBI ICDR Regulations. The Selling Shareholders have, severally and not jointly, confirmed and approved their participation in the Offer for Sale as set out below:

Selling Shareholder	Number of Equity Shares offered in the Offer for Sale	Date of consent letter
Client Ebene Limited	8,635,408	May 27, 2021
CVCIGP II Employee Ebene Limited	4,836,723	May 27, 2021
Subramonia Sekhar Vasana	2,058,069	May 31, 2021
Unni Rajagopal Kothanath	571,376	May 31, 2021
Fatheraj Singhvi *	571,376	May 31, 2021
Devappa Devaraj	571,376	May 31, 2021
Total	17,244,328	

*Fatheraj Singhvi is acting in trust for the offer for sale of up to 61,221 Equity Shares by Lalitha Singhvi, up to 62,031 Equity Shares by Praveen Singhvi, up to 62,031 Equity Shares by Lata Singhvi, up to 62,031 Equity Shares by Jayaraj Singhvi, up to 62,031 Equity Shares by Tara Singhvi and up to 62,031 Equity Shares by Indira Singhvi. Fatheraj Singhvi holds the Equity Share of the Singhvi Family Shareholders in trust, for the benefit of the Singhvi Family Shareholders. For details, see “Capital Structure” on page 68.

⁽³⁾ In the event of under-subscription in the Employee Reservation Portion (if any), the unsubscribed portion will be available for allocation and Allotment, proportionately to all Eligible Employees who have Bid in excess of ₹200,000, subject to the maximum value of Allotment made to such Eligible Employee not exceeding ₹500,000. The unsubscribed portion, if any, in the Employee Reservation Portion (after allocation up to ₹500,000), shall be added to the Net Offer. Our Company, in consultation with the BRLMs and the Selling Shareholders, may offer a discount of up to 5.00% (equivalent to up to ₹[●] per Equity Share) to the Eligible Employees Bidding under the Employee Reservation Portion. The amount of Employee Discount will be advertised in all newspapers wherein the pre-Offer advertisement will be published.

⁽⁴⁾ Our Company with the consent of the Investor Selling Shareholders in consultation with the BRLMs and the Promoter Selling Shareholders, may allocate up to 60% of the QIB Portion to Anchor Investors on a discretionary basis. One-third of the Anchor Investor Portion shall be reserved for domestic Mutual Funds, subject to valid Bids being received from domestic Mutual Funds at or above the Anchor Investor Allocation Price. In the event of under-subscription or non-Allotment in the Anchor Investor Portion, the remaining Equity Shares shall be added to the Net QIB Portion. 5% of the Net QIB Portion shall be available for allocation on a proportionate basis to Mutual Funds only, and the remainder of the Net QIB Portion shall be available for allocation on a proportionate basis to all QIB Bidders (other than Anchor Investors), including Mutual Funds, subject to valid Bids being received at or above the Offer Price. In the event the aggregate demand from Mutual Funds is less than as specified above, the balance Equity Shares available for Allotment in the Mutual Fund Portion will be added to the QIB Portion and allocated proportionately to the QIB Bidders (other than Anchor Investors) in proportion to their Bids. For details, see “Offer Procedure” on page 344.

- ⁽⁵⁾ Subject to valid Bids being received at or above the Offer Price, under-subscription, if any, in any category except the QIB Portion, would be allowed to be met with spill over from any other category or combination of categories at the discretion of our Company and the Investor Selling Shareholders in consultation with the BRLMs, the Promoter Selling Shareholders and the Designated Stock Exchange. Under-subscription, if any, in the QIB Portion would not be allowed to be met with spill-over from other categories or a combination of categories. For further details, see “Offer Structure” on page 341. In case of an undersubscription in the Offer, the Equity Shares proposed for sale by each Selling Shareholder shall be in proportion to the Offered Shares by such Selling Shareholder.
- ⁽⁶⁾ Our Company, in consultation with the BRLMs and the Selling Shareholders, may offer a discount of up to [●]% (equivalent to up to ₹[●] per Equity Share) to the Retail Individual Bidders under the Retail Portion. The amount of Retail Discount will be advertised in all newspapers wherein the pre-Offer advertisement will be published.

Allocation to all categories, except the Anchor Investor Portion and the Retail Portion, shall be made on a proportionate basis subject to valid Bids received at or above the Offer Price, as applicable. The allocation to each Retail Individual Bidder shall not be less than the minimum Bid Lot, subject to availability of Equity Shares in the Retail Portion and the remaining available Equity Shares, if any, shall be allocated on a proportionate basis. For further details, see “Offer Procedure” on page 344. For details of the terms of the Offer, see “Terms of the Offer” on page 336. For details, including in relation to grounds for rejection of Bids, refer to “Offer Structure” and “Offer Procedure” on pages 341 and 344, respectively.

SUMMARY OF FINANCIAL INFORMATION

The following tables set forth the summary financial information (excluding the notes) derived from the Restated Consolidated Financial Information for the years ended March 31, 2021, March 31, 2020 and March 31, 2019. The summary financial information presented below should be read in conjunction with “Financial Information” and “Management’s Discussion and Analysis of Financial Condition and Results of Operations” on pages 219 and 282.

SUMMARY RESTATED CONSOLIDATED STATEMENT OF ASSETS AND LIABILITIES

(₹ in million)

Particulars	As at March 31, 2021	As at March 31, 2020	As at March 31, 2019
ASSETS			
Non-current assets			
Property, Plant and Equipment	10,000.05	9,421.31	8,890.71
Capital work-in-progress	604.23	683.35	488.55
Goodwill	358.37	323.64	324.21
Other intangible asset	19.17	25.72	32.54
Right-of-use-asset	892.35	872.97	896.57
Financial assets			
(i) Investments	36.93	36.93	-
(ii) Loans	284.54	267.10	257.32
(iii) Other financial assets	14.09	34.81	34.24
Tax assets for current taxes (net)	27.14	29.30	62.48
Other non-current assets	224.70	204.68	227.03
Total non-current assets	12,461.57	11,899.81	11,213.65
Current assets			
Inventories	2,485.69	2,389.18	2,434.59
Financial assets			
(i) Investments	5.58	3.53	5.34
(ii) Trade receivables	3,129.83	2,591.21	2,712.43
(iii) Cash and cash equivalents	365.00	600.08	239.27
(iv) Bank balances other than cash and cash equivalents	286.42	116.36	76.73
(v) Other financial assets	222.81	236.47	256.46
Other current assets	331.93	445.72	516.37
Total current assets	6,827.26	6,382.55	6,241.19
Total assets	19,288.83	18,282.36	17,454.84
EQUITY AND LIABILITIES			
Equity			
Equity share capital	93.87	93.87	93.87
Instruments entirely equity in nature	105.00	105.00	105.00
Other equity	8,583.55	7,482.91	6,654.95
Total equity attributable to owners of the company	8,782.42	7,681.78	6,853.82
Non-controlling Interests	104.99	86.78	91.36
Total equity	8,887.41	7,768.56	6,945.18
Liabilities			
Non-Current Liabilities			
Financial liabilities			
(i) Non-current borrowings	1,876.52	1,718.25	2,133.84
(ii) Lease liabilities	810.28	788.59	805.71
(iii) Other financial liabilities	-	11.04	76.87
Non-current provision	151.83	126.89	85.83
Deferred tax liabilities (net)	617.98	552.27	702.98
Other non-current liabilities	467.16	425.89	421.34
Total non-current liabilities	3,923.77	3,622.93	4,226.57
Current liabilities			
Financial Liabilities			
(i) Current borrowings	2,552.32	3,554.12	3,043.08
(ii) Lease liabilities	110.88	96.94	86.48
(ii) Trade payables			
- Total outstanding dues of micro enterprises and small enterprises	86.39	67.23	91.18
- Total outstanding dues of creditors other than micro enterprises and small enterprises	2,184.07	1,661.72	1,774.46
(iv) Other financial liabilities	1,236.67	1,218.31	1,002.36

Particulars	As at March 31, 2021	As at March 31, 2020	As at March 31, 2019
Current tax liabilities (net)	0.59	29.52	82.51
Other current liabilities	207.63	164.49	137.60
Current provisions	99.10	98.54	65.42
Total current liabilities	6,477.65	6,890.87	6,283.09
Total equity and liabilities	19,288.83	18,282.36	17,454.84

SUMMARY RESTATED CONSOLIDATED STATEMENT OF PROFIT AND LOSS

(₹ in million)

Particulars	For the year ended March 31, 2021	For the year ended March 31, 2020	For the year ended March 31, 2019
Revenue			
Revenue from operations	15,492.71	14,571.70	16,244.30
Other income	230.93	159.69	163.79
Total income	15,723.64	14,731.39	16,408.09
Expenses			
Cost of material consumed	6,678.31	6,281.99	7,220.02
Changes in inventory of finished goods and work in progress	(43.71)	(18.95)	(167.01)
Conversion charges	526.15	486.79	468.80
Consumption of stores and spares	1,335.80	1,310.76	1,506.32
Power and fuel	670.65	750.55	841.31
Employee benefit expenses	2,137.50	2,134.24	2,174.07
Finance costs	473.93	580.90	512.81
Depreciation and amortisation expense	1,016.76	939.00	757.54
Other expenses	1,466.80	1,379.35	1,309.82
Total expenses	14,262.19	13,844.63	14,623.68
Profit before exceptional items and tax	1,461.45	886.76	1,784.41
Exceptional items	-	-	134.90
Profit before tax	1,461.45	886.76	1,649.51
Tax expenses:			
Current tax	303.87	235.05	492.55
Deferred tax (credit)/charge	58.98	(147.34)	176.32
Total tax expenses	362.85	87.71	668.87
Profit for the year	1,098.60	799.05	980.64
Other comprehensive income/(expense)			
Items that will not to be reclassified to profit or loss			
Re-measurement of the net defined benefit liability	(25.94)	(13.16)	(2.95)
Income tax relating to items that will not be reclassified to profit and loss	6.59	3.37	1.02
Net other comprehensive income/(expense)	(19.35)	(9.79)	(1.93)
Items that will be reclassified subsequently to profit or loss			
Exchange differences on translation of foreign operations	52.92	34.12	(31.85)
Income tax relating to items that will be reclassified to profit and loss	(13.32)	-	-
Net other comprehensive income/(expense)	39.60	34.12	(31.85)
Other comprehensive income/(expense) for the year, net of income tax	20.25	24.33	(33.78)
Total comprehensive income for the year, net of tax	1,118.85	823.38	946.86
Profit attributable to :			
Owners of the Company	1,079.86	803.10	962.13
Non-controlling interests	18.74	(4.05)	18.51
Profit for the year	1,098.60	799.05	980.64
Other comprehensive income attributable to:			
Owners of the Company	20.78	24.86	(33.71)
Non-controlling interests	(0.53)	(0.53)	(0.07)
Total other comprehensive income	20.25	24.33	(33.78)
Total comprehensive income attributable to:			
Owners of the Company	1,100.64	827.96	928.42

Particulars	For the year ended March 31, 2021	For the year ended March 31, 2020	For the year ended March 31, 2019
Non-controlling interests	18.21	(4.58)	18.44
Total comprehensive income, net of tax	1,118.85	823.38	946.86
Earnings per equity share (face value of ₹ 2 each)			
Basic (in ₹)	21.02	15.63	18.73
Diluted (in ₹)	20.55	15.28	18.31

SUMMARY RESTATED CONSOLIDATED CASH FLOW STATEMENT

(₹ in million)

Particulars	For the year ended March 31, 2021	For the year ended March 31, 2020	For the year ended March 31, 2019
Cash flows from operating activities			
Profit before tax from continuing operations	1,461.45	886.76	1,649.51
Adjustments to reconcile profit before tax to net cash flows:			
Depreciation and amortisation expense	1,016.76	939.00	757.54
Interest income	(22.42)	(10.87)	(5.77)
Income from government grants	(45.11)	(40.89)	(25.05)
Adjustment for Rental concession	(2.71)	-	-
(Profit)/ loss on sale of property, plant and equipments, net	(4.77)	(1.05)	2.51
Unrealised foreign exchange gain, net	(49.45)	45.06	24.58
Employee stock compensation expense	-	-	4.47
Loss allowance on trade receivables	-	-	0.50
Insurance claim receivable written off	11.26	10.50	9.23
Finance cost	473.93	580.90	512.81
Adjustment on fair value gain of investments	(2.05)	-	-
Other non-operating income	-	-	(14.24)
	2,836.89	2,409.41	2,916.09
Working capital adjustments			
Changes in trade receivables	(442.92)	206.27	(55.01)
Other current and non-current assets and current financial assets	41.02	59.86	(55.44)
Changes in inventory	(96.51)	45.41	(353.70)
Changes in trade payables and financial liabilities	527.14	(136.57)	35.06
Other liabilities and provisions	25.37	82.58	112.49
Cash generated from operations	2,890.99	2,666.96	2,599.49
Income taxes paid, net	(330.64)	(254.86)	(414.95)
Net cash generated from operating activities (A)	2,560.35	2,412.10	2,184.54
Cash flows from investing activities			
Purchase of property, plant and equipments	(1,351.21)	(1,767.17)	(2,381.33)
Proceeds from sale of property, plant and equipments	11.52	27.33	0.78
Receipt of government grant	92.67	37.16	-
Investments made, net	-	(36.93)	-
Interest received	22.42	10.87	5.77
Movement in fixed deposit, net	(170.06)	(42.14)	(1.28)
Net cash used in investing activities (B)	(1,394.66)	(1,770.88)	(2,376.06)
Cash flows from financing activities			
Proceeds/(repayment) of non-current borrowings:			
Proceeds	1,099.93	809.50	1,255.20
Repayment	(979.92)	(951.69)	(710.20)
Proceeds of current borrowings, net	(992.26)	490.64	148.80
Interest paid	(459.00)	(580.90)	(512.81)
Payment of principal portion of lease liabilities	(60.75)	(56.75)	(36.26)
Net cash (used in)/generated from financing activities (C)	(1,392.00)	(289.19)	144.73
Cash and cash equivalents at the beginning of the year	600.08	239.27	343.37
Effect of exchange differences on translation of foreign currency cash and cash equivalents	(8.77)	8.78	(55.95)
Net increase/(decrease) in cash and cash equivalents	(226.31)	352.03	(48.15)
Cash and cash equivalents at the end of the year (refer below)	365.00	600.08	239.27
For the purpose of statement of cash flows, cash and cash equivalents comprise the following:			
Cash on hand	0.72	1.14	1.00
Balances with banks			
- on current accounts	364.28	598.94	238.27
	365.00	600.08	239.27

GENERAL INFORMATION

Registered Office and Corporate Office

Sansera Engineering Limited

Plant 7, Plot No. 143/A
Jigani Link Road
Bommasandra Industrial Area
Anekal Taluk,
Bengaluru 560 105
Karnataka, India
Registration Number: 004542
CIN: U34103KA1981PLC004542

Address of the RoC

Our Company is registered with the RoC situated at the following address:

Registrar of Companies

'E' Wing, 2nd Floor
Kendriya Sadan
Koramangala
Bengaluru 560 034
Karnataka, India

Board

As on the date of this Red Herring Prospectus, our Board comprises the following:

Name	Designation	DIN	Address
Subramonia Sekhar Vasan	Chairman and Managing Director	00361245	#51, Oriental Home, Ranga Rao Road, Basavangudi, Bangalore South, Bengaluru 560 004, Karnataka, India
Fatheraj Singhvi	Joint Managing Director	00233146	#416, & 232, Shanthi, 8, Vishranthi Enclave, Kankpura Road, Doddakallasandra, Bengaluru 560 062, Karnataka, India
Raunak Gupta	Non-Executive, Nominee Director	06624489	B-1608, Oberoi Splendor, JVLR, Andheri (East), Mumbai 400 060, Maharashtra, India
Muthuswami Lakshminarayan	Non-Executive, Independent Director	00064750	#18 Arbors by the Lake, Kyalasanhalli, Off Jigani Link Road, Anekal Taluk, Bengaluru 560 105, Karnataka, India
Revathy Ashok	Non-Executive, Independent Director	00057539	139/6-2, Domlur Layout, Sharadamma Layout, Bengaluru 560 071, Karnataka, India
Sylvain Bilaine	Non-Executive, Independent Director	00128817	18-A, Rue Jean Marx Mamer, Luxembourg 8250

For further details of our Directors, see “*Our Management*” on page 197.

Company Secretary and Compliance Officer

Rajesh Kumar Modi

Plant 7, Plot No. 143/A, Jigani Link Road
Bommasandra Industrial Area
Anekal Taluk
Bengaluru 560 105
Karnataka, India
Tel: +91 80 2783 9081/ 9082/ 9083
E-mail: rajesh.modi@sansera.in

Filing

A copy of the Draft Red Herring Prospectus was filed electronically on the platform provided by SEBI and at cfddil@sebi.gov.in, in accordance with the instructions issued by the SEBI on March 27, 2020, in relation to “Easing of Operational Procedure – Division of Issues and Listing – CFD.”

A copy of this Red Herring Prospectus, along with the material contracts and documents required to be filed under Section 32 of the Companies Act has been delivered to the RoC for filing and a copy of the Prospectus to be filed under Section 26 of the Companies Act will be filed with the RoC at its office.

Book Running Lead Managers

ICICI Securities Limited

ICICI Centre
H.T. Parekh Marg
Church gate
Mumbai 400 020
Maharashtra, India
Tel: +91 22 2288 2460
E-mail: sansera.ipo@icicisecurities.com
Investor grievance e-mail:
customercare@icicisecurities.com
Website: www.icicisecurities.com
Contact Person: Shekher Asnani / Anurag Byas
SEBI Registration No.: INM000011179

IIFL Securities Limited

10th Floor, IIFL Centre
Kamala City, Senapati Bapat Marg
Lower Parel (West)
Mumbai 400 013
Maharashtra, India
Tel: +91 22 4646 4600
E-mail: sansera.ipo@iiflcap.com
Investor grievance e-mail: ig.ib@iiflcap.com
Website: www.iiflcap.com
Contact Person: Mukesh Garg/ Dhruv Bhagwat
SEBI Registration No.: MB/INM000010940

Nomura Financial Advisory and Securities (India) Private Limited

Ceejay House, Level 11 Plot F, Shivsagar Estate
Dr. Annie Besant Road, Worli
Mumbai 400 018
Maharashtra, India
Tel: +91 22 4037 4037
E-mail: sanseraipo@nomura.com
Investor grievance e-mail: investorgrievances-in@nomura.com
Website:
www.nomuraholdings.com/company/group/asia/india/index.html
Contact Person: Vishal Kanjani / Kshitij Thakur
SEBI Registration No.: INM000011419

Legal Counsel to our Company and Promoter Selling Shareholders as to Indian Law

Cyril Amarchand Mangaldas

3rd Floor, Prestige Falcon Tower
19, Brunton Road, Off M.G. Road
Bengaluru 560 025
Karnataka, India
Tel: +91 80 6792 2000

Legal Counsel to the Investor Selling Shareholders

Khaitan & Co

One World Centre
10th and 13th Floor, Tower 1C
841 Senapati Bapat Marg
Mumbai 400 013
Tel: +91 22 6636 5000

Legal Counsel to the BRLMs as to Indian Law

AZB & Partners

AZB House
Plot No. A8, Sector-4
Noida 201 301
Tel: +91 120 417 9999

AZB & Partners

AZB House, Peninsula Corporate Park
Ganpatrao Kadam Marg, Lower Parel
Mumbai 400 013
Tel: + 91 22 6639 6880

International Legal Counsel to the BRLMs

Duane Morris & Selvam LLP

16 Collyer Quay, #17-00
Singapore 049318
Tel.: +65 6311 0030

Statutory Auditors to our Company

Deloitte Haskins & Sells

19th Floor, 46 -Prestige Trade Tower
 Palace Road, High Grounds
 Bengaluru 560 001
 Karnataka, India
 E-mail : monishaparikh@deloitte.com
 Tel : +91 80 6188 6000
 Firm Registration No : 008072S
 Peer review no.: 008781

Except as given below, there has been no change in our auditors in the last three years preceding the date of this Red Herring Prospectus.

Changes in Statutory Auditors

Particulars	Date of change	Reason for change
Deloitte Haskins & Sells 19 th Floor, 46 -Prestige Trade Tower Palace Road High Grounds Bengaluru 560 001 Karnataka, India E-mail : monishaparikh@deloitte.com Tel : +91 80 6188 6000 Firm Registration No : 008072S Peer review no.: 008781	December 24, 2020*	Appointment for a term of five years from the conclusion of the AGM held on December 24, 2020 being the date of the 38 th AGM, till the conclusion of the 43 rd AGM
B S R & Associates LLP Embassy Golf Links Business Park Pebble Beach, B Block, 3rd Floor Off Intermediate Ring Road Bengaluru 560 071 Karnataka, India E-mail : vipinlodha@bsraffiliates.com Tel : +91 80 4682 3000 Firm Registration No : 116231W / W-100024	December 24, 2020	Retirement due to completion of term in accordance with Companies Act

*For audit of financial statements commencing from April 1, 2020

Registrar to the Offer**Link Intime India Private Limited**

C-101, 1st Floor, 247 Park
 Lal Bahadur Shastri Marg
 Vikhroli (West), Mumbai 400 083
 Maharashtra, India
 Tel: +91 22 4918 6200
 E-mail: sansera.ipo@linkintime.co.in
 Investor grievance email: sansera.ipo@linkintime.co.in
 Website: www.linkintime.co.in
 Contact Person: Shanti Gopalkrishnan
 SEBI Registration No. INR000004058

Bankers to the Offer**Escrow Collection Bank/ Refund Bank/ Public Offer Bank/ Sponsor Bank****HDFC Bank Limited**

HDFC Bank Limited, FIG OPS Department - Lodha, I
 Think Techno Campus O-3 Level, Next to
 Kanjurmarg Railway Station,
 Kanjurmarg (East), Mumbai - 400042,
 Maharashtra, India
 Telephone: +91 22 3075 2928 / 29/14
 E-mail: Lushar.gavankar@hdfcbank.com siddharth.jadhav@hdfcbank.com
 eric.bacha@hdfcbank.com, sachin.gawade@hdfcbank.com
 Website: www.hdfcbank.com
 Contact Person: Tushar Gavankar, Siddharth Jadhav, Neerav Desai, Eric Bacha and Sachin Gawade

SEBI Registration number: INBIO0000063

Bankers to our Company

Axis Bank Limited

Corporate Banking Branch
Level 3, Nitesh Timesquare
No. 8, M.G. Road
Bangalore 560 001
Karnataka, India
Tel: +91 80 6804 7300
E-mail: cbbbangalore.branchhead@axisbank.com,
k.chengappa@axisbank.com
Contact Person: Chengappa K. K.
Website: www.axisbank.com

Citibank N.A

No. 5, M.G. Road
Bangalore 560 001
Karnataka, India
Tel: +91 80 6773 0334
E-mail: alvin.francis@citi.com
Contact Person: Alvin Francis
Website: www.citibank.com/india

DBS Bank India Limited

Salarpuria Windsor, Ulsoor
Bengaluru 560 042
Karnataka, India
Tel: +91 80 6632 8830
E-mail: schakrabarti@dbs.com
Contact Person: Sounak Chakrabarti
Website: <https://www.dbs.com/in/index/default.page>

HDFC Bank Limited

4th Floor, 8/24
Salco Centre, Richmond Road
Bangalore, Karnataka, India
Tel: +91 80 6663 3049
E-mail: shilpa.ganesh@hdfcbank.com
Contact Person: Shilpa Ganesh
Website: www.hdfcbank.com

State Bank of India

Commercial Branch
1st Floor Krishi Bhavan, Hudson Circle
Bangalore 560 001
Karnataka, India
Tel: +91 8025943355
E-mail: rm2.sbi04196@sbi.co.in
Contact Person: Rajkumar Subramanyam
Website: www.onlinesbi.com

The Hongkong and Shanghai Banking Corporation Limited

No. 7, M.G. Road
Bangalore 560 001
Karnataka, India
Tel: +91 7032821400
E-mail: ayankjain@hsbc.co.in
Contact Person: Ayank Jain
Website: www.hsbc.co.in

Designated Intermediaries

Self-Certified Syndicate Banks

The banks registered with SEBI, which offer the facility of ASBA services, (i) in relation to ASBA, where the Bid Amount will be blocked by authorising an SCSB, a list of which is available on the website of SEBI at <https://www.sebi.gov.in/sebiweb/other/OtherAction.do?doRecognisedFpi=yes&intmId=35> and updated from time to time and at such other websites as may be prescribed by SEBI from time to time, (ii) in relation to RIBs using the UPI Mechanism, a list of which is available on the website of SEBI at <https://sebi.gov.in/sebiweb/other/OtherAction.do?doRecognisedFpi=yes&intmId=40> or such other website as updated from time to time.

Applications through UPI in the Offer can be made only through the SCSBs mobile applications (apps) whose name appears on the SEBI website. A list of SCSBs and mobile application, which, are live for applying in public issues using UPI mechanism is appearing in the "list of mobile applications for using UPI in public issues" displayed on the SEBI website. The said list shall be updated on the SEBI website.

Syndicate SCSB Branches

In relation to Bids (other than Bids by Anchor Investor) submitted to a member of the Syndicate, the list of branches of the SCSBs at the Specified Locations named by the respective SCSBs to receive deposits of Bid cum Application Forms from the members of the Syndicate is available on the website of the SEBI (<https://www.sebi.gov.in/sebiweb/other/OtherAction.do?doRecognisedFpi=yes&intmId=35>) and updated from time to time. For more information on such branches collecting Bid cum Application Forms from the Syndicate at Specified Locations, see the website of the SEBI <http://www.sebi.gov.in/sebiweb/other/OtherAction.do?doRecognised=yes> as updated from time to time.

Registered Brokers

The list of the Registered Brokers eligible to accept ASBA forms, including details such as postal address, telephone number and e-mail address, is provided on the websites of the Stock Exchanges at www.bseindia.com/Markets/PublicIssues/brokercentres_new.aspx and

www.nseindia.com/products/content/equities/ipos/ipo_mem_terminal.htm, respectively, as updated from time to time.

Registrar and Share Transfer Agents

The list of the RTAs eligible to accept ASBA Forms at the Designated RTA Locations, including details such as address, telephone number and e-mail address, is provided on the websites of the Stock Exchanges at www.bseindia.com/Static/Markets/PublicIssues/RtaDp.aspx and www.nseindia.com/products/content/equities/ipos/asba_procedures.htm respectively, as updated from time to time.

Collecting Depository Participants

The list of the CDPs eligible to accept ASBA Forms at the Designated CDP Locations, including details such as their name and contact details, is provided on the websites of the Stock Exchanges at www.bseindia.com/Static/Markets/PublicIssues/RtaDp.aspx and www.nseindia.com/products/content/equities/ipos/asba_procedures.htm, respectively, as updated from time to time.

Experts

Except as stated below, our Company has not obtained any expert opinions:

Our Company has received written consent dated September 6, 2021 from our Statutory Auditors namely, Deloitte Haskins & Sells, Chartered Accountants to include their name as an “expert” as defined under Section 2(38) of the Companies Act, read with Section 26(5) of the Companies Act, in respect of the examination report dated September 6, 2021 on the Restated Consolidated Financial Information, and the statement of special tax benefits dated September 6, 2021 included in this Red Herring Prospectus, and such consent has not been withdrawn as on the date of this Red Herring Prospectus. However, the term “expert” and the consent thereof shall not be construed to mean an expert or consent within the meaning as defined under the U.S. Securities Act.

Our Company has received written consent from M.S. Balu, Chartered Engineers dated June 3, 2021 and August 18, 2021, to include their name in the Draft Red Herring Prospectus and this Red Herring Prospectus, respectively, and as “expert” as defined under section 2(38) of the Companies Act in respect of the certificates dated June 3, 2021 and August 18, 2021 and such consent has not been withdrawn as on the date of this Red Herring Prospectus.

Monitoring Agency

As the Offer is an offer for sale of Equity Shares, our Company is not required to appoint a monitoring agency for this Offer.

Appraising Entity

As the Offer is an offer for sale of Equity Shares, our Company will not receive any proceeds from the Offer. Accordingly, no appraising entity has been appointed for the Offer.

Credit Rating

As the Offer is an offer for sale of Equity Shares, there is no credit rating required.

IPO Grading

As the Offer is an offer for sale of Equity Shares, no credit agency registered with SEBI has been appointed in respect of obtaining grading for the Offer.

Trustees

As the Offer is an offer for sale of Equity Shares, the appointment of trustees is not required.

Green Shoe Option

No green shoe option is contemplated under the Offer.

Inter-se allocation of responsibilities

The following table sets forth the inter-se allocation of responsibilities for various activities among the Book Running Lead Managers:

S. No.	Activity	Responsibility	Coordinator
1.	Capital structuring, due diligence of the Company including its operations/management/business plans/legal etc. Drafting and design of the Draft Red Herring Prospectus, Red Herring Prospectus, Prospectus, abridged prospectus and application form. The BRLMs shall ensure compliance with stipulated requirements and completion of prescribed	BRLMs	I-Sec

S. No.	Activity	Responsibility	Coordinator
	formalities with the Stock Exchanges, RoC and SEBI including finalisation of Prospectus and RoC filing		
2.	Drafting and approval of all statutory advertisement	BRLMs	I-Sec
3.	Drafting and approval of all publicity material other than statutory advertisement as mentioned above including corporate advertising, brochure, etc. and filing of media compliance report	BRLMs	IIFL
4.	Appointment of intermediaries - Registrar to the Offer, advertising agency, Banker(s) to the Offer, Sponsor Bank, printer and other intermediaries, including coordination of all agreements to be entered into with such intermediaries	BRLMs	I-Sec
5.	Preparation of road show presentation	BRLMs	Nomura
6.	Preparation of frequently asked questions	BRLMs	Nomura
7.	International institutional marketing of the Offer, which will cover, <i>inter alia</i> : <ul style="list-style-type: none"> marketing strategy; Finalizing the list and division of investors for one-to-one meetings; and Finalizing road show and investor meeting schedule 	BRLMs	Nomura
8.	Domestic institutional marketing of the Offer, which will cover, <i>inter alia</i> : <ul style="list-style-type: none"> marketing strategy; Finalizing the list and division of investors for one-to-one meetings; and Finalizing road show and investor meeting schedule 	BRLMs	I-Sec
9.	Retail and Non-Institutional marketing of the Offer, which will cover, <i>inter alia</i> , <ul style="list-style-type: none"> Finalising media, marketing and public relations strategy including list of frequently asked questions at retail road shows; Finalising centres for holding conferences for brokers, etc.; Follow-up on distribution of publicity and Offer material including application form, the Prospectus and deciding on the quantum of the Offer material; and Finalising collection centres 	BRLMs	IIFL
10.	Coordination with Stock Exchanges for book building software, bidding terminals, mock trading, payment of 1% security deposit, anchor coordination, anchor CAN and intimation of anchor allocation	BRLMs	IIFL
11.	Managing the book and finalization of pricing in consultation with the Company	BRLMs	I-Sec
12.	Post-Offer activities, which shall involve essential follow-up with Bankers to the Offer and SCsBs to get quick estimates of collection and advising Company about the closure of the Offer, based on correct figures, finalisation of the basis of allotment or weeding out of multiple applications, listing of instruments, dispatch of certificates or demat credit and refunds, payment of STT on behalf of the Selling Shareholders and coordination with various agencies connected with the post-Offer activity such as Registrar to the Offer, Bankers to the Offer, Sponsor Bank, SCsBs including responsibility for underwriting arrangements, as applicable. Coordinating with Stock Exchanges and SEBI for submission of all post-Offer reports including the initial and final post-Offer report to SEBI, release of 1% security deposit post closure of the Offer	BRLMs	IIFL

Book Building Process

Book Building Process, in the context of the Offer, refers to the process of collection of Bids from investors on the basis of this Red Herring Prospectus, the Bid cum Application Forms and the Revision Forms within the Price Band. The Price Band will be decided by our Company with the consent of the Investor Selling Shareholders in consultation with the BRLMs and the Promoter Selling Shareholders, and the minimum Bid Lot size will be decided by our Company and in consultation with the BRLMs and the Selling Shareholders, and advertised in all editions of Financial Express, an English national daily newspaper, Delhi edition of Jansatta, a Hindi national daily newspaper and Bangalore edition of Vishwavani a Kannada daily newspaper (Kannada being the regional language of Karnataka, where our Registered Office and Corporate Office is located) at least two Working Days prior to the Bid/ Offer Opening Date and shall be made available to the Stock Exchanges for the purpose of uploading on their respective websites. The Offer Price shall be determined by our Company (through the Board/ IPO Committee) in consultation with the BRLMs and the Selling Shareholders after the Bid/ Offer Closing Date.

All Bidders, except Anchor Investors, are mandatorily required to use the ASBA process for participating in the Offer by providing details of their respective ASBA Account in which the corresponding Bid Amount will be blocked by SCsBs. In addition to this, the RIBs may participate through the ASBA process by either (a) providing the details of their respective ASBA Account in which the corresponding Bid Amount will be blocked by the SCsBs; or (b) through the UPI Mechanism. Anchor Investors are not permitted to participate in the Offer through the ASBA process.

In accordance with the SEBI ICDR Regulations, QIBs and Non-Institutional Bidders are not allowed to withdraw or lower the size of their Bids (in terms of the quantity of the Equity Shares or the Bid Amount) at any stage. Retail Individual Bidders and Eligible Employees Bidding in the Employee Reservation Portion can revise their Bids during the Bid/ Offer Period and withdraw their Bids on or before the Bid/ Offer Closing Date. Further, Anchor Investors cannot withdraw their Bids after the Anchor Investor Bid/ Offer Period. Allocation to the Anchor Investors will be on a discretionary basis.

Each Bidder by submitting a Bid in the Offer, will be deemed to have acknowledged the above restrictions and the terms of the Offer.

Our Company will comply with the SEBI ICDR Regulations and any other directions issued by SEBI in relation to this Offer. In this regard, our Company along with the Selling Shareholders have appointed the BRLMs to manage this Offer and procure Bids for this Offer.

The Book Building Process is in accordance with guidelines, rules and regulations prescribed by SEBI and are subject to change from time to time. Bidders are advised to make their own judgement about an investment through this process prior to submitting a Bid.

For further details on the method and procedure for Bidding, see “Offer Structure” and “Offer Procedure” on pages 341 and 344, respectively.

Bidders should note that the Offer is also subject to obtaining (i) final listing and trading approvals of the Stock Exchanges, which our Company shall apply after Allotment; and (ii) filing of the Prospectus with the RoC.

Illustration of Book Building and Price Discovery Process

For an illustration of the Book Building Process and the price discovery process, see “Offer Procedure” on page 344.

Underwriting Agreement

After the determination of the Offer Price and allocation of Equity Shares, but prior to the filing of the Prospectus with the RoC, our Company and the Selling Shareholders intend to enter into an Underwriting Agreement with the Underwriters for the Equity Shares proposed to be issued and offered in the Offer. The Underwriting Agreement is dated [●]. Pursuant to the terms of the Underwriting Agreement, the obligations of each of the Underwriters will be several and will be subject to certain conditions specified therein.

The Underwriters have indicated their intention to underwrite the following number of Equity Shares pursuant to the Underwriting Agreement:

(This portion has been intentionally left blank and will be filled in before filing of the Prospectus with the RoC.)

Name, Address, Telephone Number and Email Address of the Underwriters	Indicative Number of Equity Shares to be Underwritten	Amount Underwritten (₹ in million)
[●]	[●]	[●]

The abovementioned underwriting commitments are indicative and will be finalised after pricing of the Offer, the Basis of Allotment and actual allocation in accordance with provisions of the SEBI ICDR Regulations.

In the opinion of our Board (based on representations made by the Underwriters), the resources of the abovementioned Underwriters are sufficient to enable them to discharge their respective underwriting obligations in full. The abovementioned Underwriters are registered with the SEBI under Section 12(1) of the SEBI Act or registered as brokers with the Stock Exchanges. Our Board/ IPO Committee, at its meeting held on [●], has accepted and entered into the Underwriting Agreement mentioned above on behalf of our Company.

Allocation among the Underwriters may not necessarily be in proportion to their underwriting commitment set forth in the table above.

Notwithstanding the above table, the Underwriters shall be severally responsible for ensuring payment with respect to the Equity Shares allocated to investors respectively procured by them in accordance with the Underwriting Agreement. In the event of any default in payment, the respective Underwriter, in addition to other obligations defined in the Underwriting Agreement, will also be required to procure subscribers for or subscribe to the Equity Shares to the extent of the defaulted amount in accordance with the Underwriting Agreement. The Underwriting Agreement has not been executed as on the date of this Red Herring Prospectus and will be executed after determination of the Offer Price and allocation of Equity Shares, but prior to the filing of the Prospectus with the RoC. The extent of underwriting obligations and the Bids to be underwritten in the Offer shall be as per the Underwriting Agreement.

CAPITAL STRUCTURE

The share capital of our Company as at the date of this Red Herring Prospectus is set forth below:

(in ₹, except share data)

	Particulars	Aggregate nominal value (₹)	Aggregate value at Offer Price*
A	AUTHORIZED SHARE CAPITAL⁽¹⁾		
	62,500,000 Equity Shares of face value of ₹2 each	125,000,000	[●]
	300,000 Series A CCPS of face value ₹100 each	30,000,000	[●]
	750,000 Series B CCPS of face value ₹100 each	75,000,000	[●]
B	ISSUED, SUBSCRIBED AND PAID-UP SHARE CAPITAL BEFORE THE OFFER		
	51,377,850 Equity Shares of face value of ₹2 each	102,755,700	[●]
C	PRESENT OFFER IN TERMS OF THIS RED HERRING PROSPECTUS⁽²⁾		
	Offer for Sale of up to 17,244,328 Equity Shares of face value of ₹2 each aggregating up to ₹[●] million ⁽³⁾	34,488,656	[●]
	Employee Reservation Portion of up to [●] Equity Shares aggregating up to ₹90 million ⁽⁴⁾	[●]	[●]
	Net Offer	[●]	[●]
D	ISSUED, SUBSCRIBED AND PAID-UP SHARE CAPITAL AFTER THE OFFER		
	51,377,850 Equity Shares of face value of ₹2 each	102,755,700	[●]
E	SECURITIES PREMIUM ACCOUNT		
	Before the Offer		1,312,875,380
	After the Offer		[●]

*To be finalized upon determination of the Offer Price

- (1) For details in relation to the changes in the authorised share capital of our Company, see "History and Certain Corporate Matters" on page 188
- (2) The Offer has been authorized by a resolution of our Board of Directors dated March 18, 2021 and a special resolution of our Shareholders in their Annual General Meeting dated June 2, 2021.
- (3) Each Selling Shareholder severally and not jointly confirms that the Offered Shares have been held by such Selling Shareholder for a period of at least one year prior to the filing of the Draft Red Herring Prospectus in accordance with Regulation 8 of the SEBI ICDR Regulations and accordingly, are eligible for the Offer in accordance with the provisions of the SEBI ICDR Regulations. For details on the authorization of each of the Selling Shareholders in relation to their respective Offered Shares, see "The Offer" on page 54
- (4) Eligible Employees bidding in the Employee Reservation Portion must ensure that the maximum Bid Amount does not exceed ₹500,000 (net of Employee Discount). However, the initial Allotment to an Eligible Employee in the Employee Reservation Portion shall not exceed ₹200,000 (net of Employee Discount). Only in the event of an under-subscription in the Employee Reservation Portion post the initial Allotment, such unsubscribed portion may be Allotted on a proportionate basis to Eligible Employees Bidding in the Employee Reservation Portion, for a value in excess of ₹200,000 (net of Employee Discount), subject to the total Allotment to an Eligible Employee not exceeding ₹500,000 (net of Employee Discount).

Notes to the capital structure

1. Share Capital History of our Company

(a) Equity Share Capital

The history of the Equity Share capital of our Company is provided in the following table:

Date of allotment	No. of equity shares allotted	Face Value per equity share (₹)	Issue price per equity share (₹)	Nature of consideration	Reason/ Nature of transaction	Cumulative number of equity shares	Cumulative paid-up equity share capital (₹)
December 15, 1981	30	100	100	Cash	Initial subscription to the MoA ⁽¹⁾	30	3,000
March 5, 1984*	970	100	100	Cash	Preferential allotment ⁽²⁾	1,000	100,000
June 20, 1990	5,500	100	100	Cash	Preferential allotment ⁽³⁾	6,500	650,000
September 13, 1994	13,500	100	NA	NA	Bonus issue ⁽⁴⁾	20,000	2,000,000
September 28, 1998	15,000	100	100	Cash	Preferential allotment ⁽⁵⁾	35,000	3,500,000
March 29, 1999	5,000	100	100	Cash	Preferential allotment ⁽⁶⁾	40,000	4,000,000
December 30, 2000	20,000	100	100	Cash	Preferential allotment ⁽⁷⁾	60,000	6,000,000
March 30, 2006	4,150	100	77,500	Cash	Preferential allotment ⁽⁸⁾	64,150	6,415,000

Date of allotment	No. of equity shares allotted	Face Value per equity share (₹)	Issue price per equity share (₹)	Nature of consideration	Reason/ Nature of transaction	Cumulative number of equity shares	Cumulative paid-up equity share capital (₹)
April 10, 2006	2,350	100	77,500	Cash	Preferential allotment ⁽⁹⁾	66,500	6,650,000
May 15, 2006	1,300	100	77,500	Cash	Preferential allotment ⁽¹⁰⁾	67,800	6,780,000
November 8, 2006	2,100	100	77,500	Cash	Preferential allotment ⁽¹¹⁾	69,900	6,990,000
January 3, 2012	300	100	99,930	Cash	Preferential allotment ⁽¹²⁾	70,200	7,020,000
The board of directors of our Company accepted the letters of offer received for a buy back of 5,460 equity shares on April 14, 2012, and our Company completed the buy back of 5,460 equity shares on April 16, 2012 at a price of ₹64,102 per equity share thereby reducing the total number of issued and paid-up equity shares to 64,740 equity shares ⁽¹³⁾							
Pursuant to the Board and Shareholders resolution dated July 27, 2018 and July 28, 2018, respectively, every one equity share of face value ₹100 each was sub-divided into 50 equity shares of ₹2 each, and accordingly, 64,740 equity shares of face value ₹100 each were sub-divided into 3,237,000 equity shares of face value ₹2 each							
July 31, 2018 [^]	43,699,500	2	NA	NA	Bonus issue ⁽¹⁴⁾	46,936,500	93,873,000
September 3, 2021	2,845,625	2	NA	NA	Conversion of Series A CCPS ⁽¹⁵⁾	49,782,125	99,564,250
September 3, 2021	1,594,275	2	NA	NA	Conversion of Series A CCPS ⁽¹⁶⁾	51,376,400	102,752,800
September 3, 2021	725	2	NA	NA	Conversion of Series B CCPS ⁽¹⁷⁾	51,377,125	102,754,250
September 3, 2021	725	2	NA	NA	Conversion of Series B CCPS ⁽¹⁸⁾	51,377,850	102,755,700

*The Form 2 filed with RoC in relation to the allotment of 970 equity shares is untraceable. For further details, see "Risk Factors – Our Company was incorporated in 1981 and therefore we are unable to trace some of our historical records. We cannot assure you that no legal proceedings or regulatory actions will be initiated against our Company in the future in relation to the missing filings and corporate records, which may adversely impact our financial condition and reputation." on page 39

[^] The shareholders resolution approving the bonus issue of Equity Shares was passed on July 28, 2018, and subsequently, the allotment of Equity Shares was made on July 31, 2018

- (1) 10 equity shares each were subscribed by S S Vasan, S R Das and Subramonia Sekhar Vasan
- (2) Allotted 530 equity shares to Subramonia Sekhar Vasan, 250 equity shares to S S Vasan, 90 equity shares to S R Das and 100 equity shares to Kumar Mahadevan
- (3) Allotted 5,150 equity shares to Subramonia Sekhar Vasan, 100 equity shares to Tara Rajagopal and 250 equity shares to Lalitha Singhvi
- (4) Bonus issue of 540 equity shares to Manjula Sekhar, 6,469 equity shares to Subramonia Sekhar Vasan, 208 equity shares to Karthik Das, 208 equity shares to Kumar Mahadevan, 520 equity shares to Lalitha Singhvi, 208 equity shares to Tara Rajagopal, 779 equity shares to Vikram Unni, 623 equity shares to K. Devappa, 156 equity shares to Bhagyalakshmi Devaraj, 519 equity shares to Namitha Devaraj, 1,090 equity shares to Prashanth Singhvi, 519 equity shares to Niveditha Devaraj, 415 equity shares to Bela Singhvi, 1,038 equity shares to Tarun Unni and 208 equity shares to Devaraj (HUF), pursuant to capitalisation of ₹1.35 million from our Company's revaluation reserve account
- (5) Allotted 8,250 equity shares to Subramonia Sekhar Vasan, 577 equity shares to Lalitha Singhvi, 231 equity shares to Tara Rajagopal, 866 equity shares to Vikram Unni, 175 equity shares to Bhagya Lakshmi, 578 equity shares to Namitha Devaraj, 1,210 equity shares to Prashanth Singhvi, 579 equity shares to Nivedita Devaraj, 463 equity shares to Bela Singhvi, 1,153 equity shares to Tarun Unni and 918 equity shares to Devappa Devaraj (HUF)
- (6) Allotted 2,750 equity shares to Subramonia Sekhar Vasan, 193 equity shares to Lalitha Singhvi, 77 equity shares to Tara Rajagopal, 288 equity shares to Vikram Unni, 56 equity shares to Bhagya Lakshmi, 191 equity shares to Namitha Devaraj, 405 equity shares to Prashanth Singhvi, 190 equity shares to Nivedita Devaraj, 152 equity shares to Bela Singhvi, 385 equity shares to Tarun Unni, 313 equity shares to Devappa Devaraj (HUF)
- (7) Allotted 11,000 equity shares to Manjula Sekhar, 770 equity shares to Lalitha Singhvi, 1,615 equity shares to Prashanth Singhvi, 615 equity shares to Bela Singhvi, 308 equity shares to Tara Rajagopal, 1,154 equity shares to Vikram Unni, 1,538 equity shares to Tarun Unni, 231 equity shares to Bhagya Lakshmi, 769 equity shares to Namitha Devaraj, 769 equity shares to Nivedita Devaraj, 308 equity shares to Devaraj (HUF) and 923 equity shares to Devappa Devaraj
- (8) Allotted 4,150 equity shares to Monsoon India Inflection Fund 2 Limited
- (9) Allotted 2,350 equity shares to Monsoon India Inflection Fund Limited
- (10) Allotted 130 equity shares to Positive Securities Private Limited, 320 equity shares to Tower Promoters Private Limited, 65 equity shares to Echjay Industries Private Limited, 65 equity shares to Siddharth Pai, 65 equity shares to Pranav Pai, 195 equity shares to Sweet Solutions Limited, 195 equity shares to Esquire Private Limited and 265 equity shares to Pioneer Investcorp Limited
- (11) Allotted 2,100 equity shares to Streparava holding s.p.a Italy
- (12) Allotted 300 equity shares to Nissin Manufacturing Co. Limited
- (13) Bought back 3,237 equity shares from Monsoon India Inflection Fund 2 Limited, 1,833 equity shares from Monsoon India Inflection Fund Limited, 195 equity shares from Esquire Private Limited and 195 equity shares from IL&FS Trust Company Limited
- (14) Bonus issue in the ratio of 27 Equity Shares for every two Equity Shares, authorised by the shareholders of our Company on July 28, 2018, was undertaken through the capitalisation of the free reserves of our Company to persons who were the shareholders of our Company on July 27, 2018
- (15) Conversion of 192,300 Series A CCPS held by Client Ebene Limited into 2,845,625 equity shares
- (16) Conversion of 107,700 Series A CCPS held by CVCIGP II Employee Ebene Limited into 1,594,275 equity shares
- (17) Conversion of 480,750 Series B CCPS held by Client Ebene Limited into 725 equity shares
- (18) Conversion of 269,250 Series B CCPS held by CVCIGP II Employee Ebene Limited into 725 equity shares

(b) Preference Share Capital History of our Company

The history of preference share capital of our Company is provided in the following table:

Date of allotment	No. of preference shares allotted	Face value per preference share (₹)	Issue price per preference share (₹)	Nature of Consideration	Reason/ Nature of transaction	Cumulative number of preference shares	Cumulative paid-up preference share capital (₹)
Series A CCPS							
July 8, 2013	300,000	100	2,666.67	Cash	Preferential allotment ⁽¹⁾	300,000	30,000,000
September 3, 2021	(300,000)	100	NA	NA	Conversion of 300,000 Series A CCPS ⁽²⁾	-	-
Series B CCPS							
July 8, 2013	750,000	100	100	Cash	Preferential allotment ⁽³⁾	750,000	75,000,000
September 3, 2021	(750,000)	100	NA	NA	Conversion of 750,000 Series B CCPS ⁽⁴⁾	-	-

(1) 192,300 Series A CCPS were allotted to Client Ebene Limited and 107,700 Series A CCPS were allotted to CVCIGP II Employee Ebene Limited.

(2) Conversion of (i) 192,300 Series A CCPS held by Client Ebene Limited into 2,845,625 equity shares and (ii) 107,700 Series A CCPS held by CVCIGP II Employee Ebene Limited into 1,594,275 equity shares

(3) 480,750 Series B CCPS were allotted to Client Ebene Limited and 269,250 Series B CCPS were allotted to CVCIGP II Employee Ebene Limited.

(4) Conversion of (i) 480,750 Series B CCPS held by Client Ebene Limited into 725 equity shares and (ii) 269,250 Series B CCPS held by CVCIGP II Employee Ebene Limited into 725 equity shares

As of the date of this Red Herring Prospectus, our Company does not have any outstanding preference share capital.

2. Issue of Equity Shares at a price lower than the Offer Price in the last year

Our Company has not issued Equity Shares at a price which may be lower than the Offer Price, during a period of one year preceding the date of this Red Herring Prospectus:

3. Issue of shares for consideration other than cash or bonus or out of revaluation of reserves

Except as stated below, our Company has not made any bonus issue of any kind or class out of its revaluation reserves.

Date of allotment	No. of equity shares allotted	Face Value per equity share (₹)	Issue price per equity share (₹)	Nature of consideration	Reason/ Nature of transaction	Benefits accrued to the Company
September 13, 1994	13,500	100	NA	NA	Bonus issue ⁽¹⁾	-
July 31, 2018	43,699,500	2	NA	NA	Bonus issue ⁽²⁾	-

⁽¹⁾ Bonus issue of 540 equity shares to Manjula Sekhar, 6,469 equity shares to Subramonia Sekhar Vasan, 208 equity shares to Karthik Das, 208 equity shares to Kumar Mahadevan, 520 equity shares to Lalitha Singhvi, 208 equity shares to Tara Rajagopal, 779 equity shares to Vikram Unni, 623 equity shares to K. Devappa, 156 equity shares to Bhagyalakshmi Devaraj, 519 equity shares to Namitha Devaraj, 1,090 equity shares to Prashanth Singhvi, 519 equity shares to Niveditha Devaraj, 415 equity shares to Bela Singhvi, 1,038 equity shares to Tarun Unni and 208 equity shares to Devaraj (HUF), pursuant to capitalisation of ₹1.35 million from our Company's revaluation reserve account

⁽²⁾ Bonus issue in the ratio of 27 Equity Shares for every two Equity Shares, authorised by the shareholders of our Company on July 28, 2018, was undertaken through the capitalisation of the free reserves of our Company to persons who were the shareholders of our Company on July 27, 2018

4. Issue of equity shares pursuant to schemes of arrangements

Our Company has not allotted any Equity Shares pursuant to a scheme of amalgamation approved under Section 391 to 394 of the Companies Act, 1956 or Sections 230 to 234 of the Companies Act.

5. History of equity share capital held by our Promoters

As on the date of this Red Herring Prospectus, our Promoters hold 21,839,200 Equity Shares, equivalent to 40.64% of the issued, subscribed and paid-up Equity Share capital (assuming exercise of vested employee stock options) of our Company.

(a) Build-up of the shareholding of our Promoters in our Company

Set forth below is the build-up of the shareholding of our Promoters since incorporation of our Company:

Date of allotment/ transfer	Nature of transaction	No. of equity shares	Nature of consideration	Face value per equity share (₹)	Issue/ Acquisition/Transfer price per equity share (₹)	Percentage of the pre-Offer Equity Share capital# (%)	Percentage of the post-Offer Equity Share capital# (%)
Subramonia Sekhar Vasan							
December 15, 1981	Initial subscription to the MoA	10	Cash	100	100	0.00*	0.00*
March 5, 1984	Preferential allotment	530	Cash	100	100	0.00*	0.00*
June 20, 1990	Preferential allotment	5,150	Cash	100	100	0.01	0.01
May 18, 1993	Transfer of Equity Shares ⁽¹⁾	(2,575)	Cash	100	100	(0.00)	(0.00)
September 13, 1994	Bonus Issue	6,469	NA	100	NA	0.01	0.01
September 28, 1998	Preferential allotment	8,250	Cash	100	100	0.02	0.02
March 29, 1999	Preferential allotment	2,750	Cash	100	100	0.01*	0.01
December 5, 2001	Transfer of Equity Shares ⁽²⁾	6,100	NA	100	Nil	0.01	0.01
March 25, 2002	Transfer of Equity Shares ⁽³⁾	(6,100)	NA	100	Nil	(0.01)	(0.01)
January 9, 2006	Transfer of Equity Shares ⁽⁴⁾	(150)	Cash	100	6,666.67	(0.00*)	(0.00*)
April 20, 2009	Transfer of Equity Shares ⁽⁵⁾	(1)	Cash	100	100	(0.00*)	(0.00*)
March 18, 2013	Transfer of Equity Shares ⁽⁶⁾	3,010	NA	100	Nil	0.01*	0.01
April 17, 2013	Transmission of Equity Shares ⁽⁷⁾	1	NA	100	Nil	0.00*	0.00*
July 8, 2013	Transfer of Equity Shares ⁽⁸⁾	(7,623)	Cash	100	75,240	(0.01)	(0.01)
July 15, 2013###	Transfer of Equity Shares ⁽⁹⁾	1,155	Cash	100	75,240	0.00*	0.00*
Pursuant to the Board and Shareholders resolution dated July 27, 2018 and July 28, 2018, respectively, every one equity share of face value ₹100 each was sub-divided into 50 equity shares of ₹2 each, and accordingly, 16,976 equity shares of face value ₹100 each held by Subramonia Sekhar Vasan were sub-divided into 848,800 equity shares of face value ₹2 each							
July 31, 2018##	Bonus issue	11,458,800	NA	2	NA	21.32	21.32
Total (A)		12,307,600				22.90	22.90^
Fatheraj Singhvi							
March 30, 2006	Transfer of Equity Shares ⁽¹⁰⁾	1,800	NA	100	Nil	0.00*	0.00*
July 8, 2013	Transfer of Equity Shares ⁽¹¹⁾	(50)	NA	100	Nil	(0.00*)	(0.00*)
July 8, 2013	Transfer of Equity Shares ⁽¹²⁾	(152)	Cash	100	75,240	(0.00*)	(0.00*)
July 8, 2013	Transfer of Equity Shares** ⁽¹³⁾	2,800	NA	100	Nil	0.01	0.01
July 15, 2013###	Transfer of Equity Shares ⁽¹⁴⁾	315	Cash	100	75,240	0.00*	0.00
Pursuant to the Board and Shareholders resolution dated July 27, 2018 and July 28, 2018, respectively, every one equity							

Date of allotment/ transfer	Nature of transaction	No. of equity shares	Nature of consideration	Face value per equity share (₹)	Issue/ Acquisition/Transfer price per equity share (₹)	Percentage of the pre-Offer Equity Share capital# (%)	Percentage of the post-Offer Equity Share capital# (%)
share of face value ₹100 each was sub-divided into 50 equity shares of ₹2 each, and accordingly, 4,713 equity shares of face value ₹100 each held by Fatheraj Singhvi were sub-divided into 235,650 equity shares of face value ₹2 each							
July 31, 2018##	Bonus issue	3,181,275**	NA	2	NA	5.92	5.92
April 27, 2021	Transfer of Equity Shares ⁽¹⁵⁾	(50,000)	NA	2	Nil	(0.09)	(0.09)
Total (B)		3,366,925**				6.27	6.27^
Unni Rajagopal Kothenath							
March 30, 2006	Transfer of Equity Shares ⁽¹⁶⁾	8,076	NA	100	Nil	0.02	0.02
March 18, 2013	Transfer of Equity Shares ⁽¹⁷⁾	(1,200)	NA	100	Nil	(0.00*)	(0.00*)
April 17, 2013	Transfer of Equity Shares ⁽¹⁸⁾	65	Cash	100	139,131.51	0.00*	0.00*
July 8, 2013	Transfer of Equity Shares ⁽¹⁹⁾	(300)	NA	100	Nil	(0.00*)	0.00*
July 8, 2013	Transfer of Equity Shares ⁽²⁰⁾	(2,243)	Cash	100	75,240	(0.00*)	(0.00*)
July 15, 2013###	Transfer of Equity Shares ⁽²¹⁾	315	Cash	100	75,240	0.00*	0.00*
Pursuant to the Board and Shareholders resolution dated July 27, 2018 and July 28, 2018, respectively, every one equity share of face value ₹100 each was sub-divided into 50 equity shares of ₹2 each, and accordingly, 4,713 equity shares of face value ₹100 each held by Unni Rajagopal Kothenath were sub-divided into 235,650 equity shares of face value ₹2 each							
July 31, 2018##	Bonus issue	3,181,275	NA	2	NA	5.92	5.92
Total (C)		3,416,925				6.36	6.36^
Devappa Devaraj							
May 25, 1999	Transmission of Equity Shares from K Devappa ⁽²²⁾	923	NA	100	Nil	0.00*	0.00*
May 25, 1999	Transfer of Equity Shares ⁽²³⁾	923	NA	100	Nil	0.00*	0.00*
December 30, 2000	Preferential allotment	923	Cash	100	100	0.00*	0.00*
March 30, 2006	Transfer of Equity Shares ⁽²⁴⁾	3,614	NA	100	Nil	0.01*	0.01
April 17, 2013	Transfer of Equity Shares ⁽²⁵⁾	65	Cash	100	139,131.51	0.00*	0.00*
May 6, 2013	Transfer of Equity Shares ⁽²⁶⁾	(923)	NA	100	Nil	(0.00*)	(0.00*)
July 8, 2013	Transfer of Equity Shares ⁽²⁷⁾	(300)	NA	100	Nil	(0.00*)	(0.00*)
July 8, 2013	Transfer of Equity Shares ⁽²⁸⁾	(1,750)	Cash	100	75,240	(0.00*)	(0.00*)
July 8, 2013	Transfer of Equity Shares ^{^(29)}	923	NA	100	Nil	0.00*	0.00*
July 15, 2013###	Transfer of Equity Shares ⁽³⁰⁾	315	Cash	100	75,240	0.00*	0.00*

Date of allotment/ transfer	Nature of transaction	No. of equity shares	Nature of consideration	Face value per equity share (₹)	Issue/ Acquisition/ Transfer price per equity share (₹)	Percentage of the pre- Offer Equity Share capital# (%)	Percentage of the post- Offer Equity Share capital# (%)
Pursuant to the Board and Shareholders resolution dated July 27, 2018 and July 28, 2018, respectively, every one equity share of face value ₹100 each was sub-divided into 50 equity shares of ₹2 each, and accordingly, 4,713 equity shares of face value ₹100 each held by Devappa Devaraj were sub-divided into 235,650 equity shares of face value ₹2 each							
July 2018##	31, Bonus issue	3,181,275	NA	2	NA	5.92	5.92
March 2021	30, Transfer of Equity Shares ⁽³¹⁾	(669,175)	NA	2	Nil	(1.25)	(1.25)
Total (D)		2,747,750				5.11	5.11[^]
Total (A+B+C+D)		21,839,200				40.64	40.64[^]

* Less than 0.01%. Numbers have been rounded off to the nearest decimal.

[^] Pursuant to the Offer, Subramonia Sekhar Vasam is offering to sell 2,058,069 Equity Shares while Unni Rajagopal Kothenath, Fatheraj Singhvi and Devappa Devaraj are each offering to sell 571,376 Equity Shares. For further details of the portion of Offer Shares of the Promoters, see "The Offer" on page 54. For details of the post-Offer Equity Share capital on a fully diluted basis, that will be held by each of the Promoters, on the assumption that the Offer is fully subscribed, see "- Selling Shareholders' Shareholding in our Company" on page 78.

[#] The percentage has been calculated assuming dilution exercise of vested employee stock options. The paid-up Equity Share capital of our Company post exercise of vested employee stock options shall comprise of 53,739,900 Equity Shares.

^{##} The shareholders resolution approving the bonus issue of Equity Shares was passed on July 28, 2018, and subsequently the allotment of Equity Shares was made on July 31, 2018

^{###} The transfer was approved pursuant to a circular resolution dated July 15, 2013, and was noted by the Board on August 27, 2013

[^] The Form-2 filed with RoC in relation to the allotment of 970 equity shares (of which 530 equity shares were allotted to Subramonia Sekhar Vasam) is untraceable. For further details of untraceable documents and risk involved, please see "Risk Factors – Our Company was incorporated in 1981 and therefore we are unable to trace some of our historical records. We cannot assure you that no legal proceedings or regulatory actions will be initiated against our Company in the future in relation to the missing filings and corporate records, which may impact our financial condition and reputation." on page 39

^{**} Pursuant to the provisions of a memorandum of understanding executed between Fatheraj Singhvi and the Singhvi Family Shareholders, dated May 15, 2013, Fatheraj Singhvi is acting in trust in relation to 2,030,000 Equity Shares held by the Singhvi Family Shareholders

(1) Subramonia Sekhar Vasam transferred 250 equity shares to Namitha; 100 equity shares to Devappa Devaraj HUF; 375 equity shares to Vikram Unni; 500 equity shares to Tarun Unni; 200 equity shares to Bela Singhvi; 250 equity shares to Niveditha; 525 equity shares to Prashanth; 75 equity shares to Bhagyalakshmi; 300 equity shares to K Devappa

(2) Manjula Vasam transferred 6,100 equity shares to Subramonia Sekhar Vasam

(3) Subramonia Sekhar Vasam transferred 6,100 equity shares to Radha Vasam

(4) Subramonia Sekhar Vasam transferred 50 equity shares to S R Balakrishnan & Manjula Balakrishnan, 50 equity shares to Manjula Balakrishnan & Balakrishnan S R; and 50 equity shares to Arjun Balakrishnan & Manjula Balakrishnan

(5) S Sekhar Vasam transferred one equity share to Seethalakshmi Venkatesan

(6) Manjula Sekhar transferred 3,010 equity shares to Subramonia Sekhar Vasam

(7) One equity share was transmitted from Seethalakshmi Venkatesan to S Sekhar Vasam

(8) Subramonia Sekhar Vasam transferred 4,886 equity shares to Client Ebene Limited and 2,737 equity shares to EEL

(9) Streparava Holding s.p.a transferred 1,155 equity shares to Subramonia Sekhar Vasam

(10) Prashant Singhvi and Bela Singhvi transferred 600 equity shares and 1,200 equity shares, respectively to Fatheraj Singhvi

(11) Fatheraj Singhvi transferred 50 equity shares to P Singhvi Charitable Trust

(12) Fatheraj Singhvi transferred 97 equity shares to Client Ebene Limited and 55 equity shares to EEL

(13) Lalitha Singhvi transferred 300 equity shares, Praveen Singhvi transferred 500 equity shares, Lata Singhvi transferred 500 equity shares, Jayaraj Singhvi transferred 500 equity shares, Tara Singhvi transferred 500 equity shares and Indira Singhvi transferred 500 equity shares to Fatheraj Singhvi. Fatheraj Singhvi is holding the equity shares transferred, in trust and for the benefit of the said transferees, i.e., the Singhvi Family Shareholders, pursuant to the provisions of a memorandum of understanding executed between Fatheraj Singhvi and the Singhvi Family Shareholders, dated May 15, 2013

(14) Streparava Holding s.p.a transferred 315 equity shares to Fatheraj Singhvi

(15) Fatheraj Singhvi transferred 50,000 Equity Shares to P. Singhvi Charitable Trust

(16) Vikram Unni and Tarun Unni transferred 3,462 equity shares and 4,614 equity shares, respectively to Unni Rajagopal Kothenath

(17) Unni Rajagopal Kothenath transferred 600 equity shares each to Tarun Unni and Vikram Unni

(18) Siddarth Pai transferred 65 equity shares to Unni Rajagopal Kothenath

(19) Unni Rajagopal Kothenath transferred 300 equity shares to The Advaya Rajagopal Adhishtaana

(20) Unni Rajagopal K transferred 1,438 equity shares to Client Ebene Limited and 805 equity shares to EEL

(21) Streparava Holding s.p.a transferred 315 equity shares to Unni Rajagopal Kothenath

(22) 923 equity share were transmitted from K Devappa to Devappa Devaraj

(23) Devappa Devaraj HUF transferred 923 equity shares to Devappa Devaraj

(24) Namitha Devaraj and Niveditha Devaraj transferred 1,807 equity shares each to Devappa Devaraj

(25) Pranav Pai transferred 65 equity shares to Devappa Devaraj

(26) Devappa Devaraj transferred 923 equity shares to Devappa Devaraj HUF

(27) Devappa Devaraj transferred 300 equity shares to Devabhagya Foundation

(28) Devappa Devaraj transferred 1,122 equity shares to CLE and 628 equity shares to EEL

(29) Devappa Devaraj HUF transferred 923 equity shares to Devappa Devara. Devappa Devaraj is holding the equity shares transferred, in trust and for the benefit of Devappa Devaraj HUF, pursuant to the provisions of a memorandum of understanding executed between

Devappa Devaraj and the Devappa Devaraj HUF, dated May 15, 2013

⁽³⁰⁾ *Streparava Holding s.p.a transferred 315 equity shares to Devappa Devaraj*

⁽³¹⁾ *Devappa Devaraj transferred 669,175 Equity Shares to Devappa Devaraj HUF*

All the Equity Shares held by our Promoters were fully paid-up on the respective dates of acquisition of such Equity Shares. None of the Equity Shares held by our Promoters have been pledged as on the date of this Red Herring Prospectus.

(b) Details of Promoters' contribution and lock-in:

Pursuant to Regulations 14 and 16 of the SEBI ICDR Regulations, an aggregate of the 20% of the fully diluted post-Offer Equity Share capital of our Company held by our Promoters (assuming exercise of all vested employee stock options) shall be locked in for a period of three years as minimum Promoters' contribution ("**Minimum Promoters' Contribution**") from the date of Allotment and the shareholding of the Promoters in excess of 20% of the fully diluted post-Offer Equity Share capital shall be locked in for a period of one year from the date of Allotment.

Details of the Equity Shares to be locked-in for three years from the date of Allotment as Minimum Promoters' Contribution are set forth in the table below:

Name of the Promoter	No. of Equity Shares locked-in	Date of allotment/ transfer of Equity Shares and when made fully paid-up	Nature of Transaction	Face value per Equity Share (₹)	Offer/ Acquisition price per Equity Share (₹)	Percentage of the fully diluted pre-Offer paid-up capital* (%)	Percentage of the fully diluted post-Offer paid-up capital* (%)	Date up to which Equity Shares are subject to lock-in
Unni Rajagopal Kothenath	1,628,000	July 31, 2018 [#]	Bonus Shares	2	NA	3.03	3.03	[●]
Subramonia Sekhar Vasani	5,863,980	July 31, 2018 [#]	Bonus Shares	2	NA	10.91	10.91	[●]
Fatheraj Singhvi	1,628,000	July 31, 2018 [#]	Bonus Shares	2	NA	3.03	3.03	[●]
Devappa Devaraj	1,628,000	July 31, 2018 [#]	Bonus Shares	2	NA	3.03	3.03	[●]
TOTAL	10,747,980	-	-	-	-	20.00	20.00	

[#] The shareholders resolution approving the bonus issue of Equity Shares was passed on July 28, 2018, and subsequently the allotment of Equity Shares was made on July 31, 2018.

*The percentage has been calculated assuming exercise of vested employee stock options.

The Equity Shares that are to be locked-in are not ineligible for computation of Minimum Promoters' Contribution under Regulation 15 of the SEBI ICDR Regulations. In this regard, our Company confirms the following:

- The Equity Shares offered for Minimum Promoters' Contribution do not include (i) Equity Shares acquired in the three immediately preceding years for consideration other than cash and revaluation of assets or capitalisation of intangible assets was involved in such transaction, (ii) Equity Shares resulting from bonus issue by utilisation of revaluation reserves or unrealised profits of our Company or bonus shares issued against Equity Shares, which are otherwise ineligible for computation of Minimum Promoters' Contribution.
- The Minimum Promoters' Contribution does not include any Equity Shares acquired during the immediately preceding one year at a price lower than the price at which the Equity Shares are being offered to the public in the Offer.
- Our Company has not been formed by the conversion of one or more partnership firms or a limited liability partnership firm.
- All the Equity Shares held by our Promoters are in dematerialised form.

Our Promoters have agreed not to sell, transfer, charge, pledge or otherwise encumber in any manner, the Promoters' contribution from the date of filing of this Red Herring Prospectus, until the expiry of the lock-in specified above, or for such other time as required under SEBI ICDR Regulations, except as may be permitted, in accordance with the SEBI ICDR Regulations.

(c) Details of share capital locked-in for one year:

In terms of the Regulation 17 of the SEBI ICDR Regulations, in addition to the Equity Shares proposed to be locked-in as part of the Minimum Promoters' Contribution, the entire pre-Offer Equity Share capital of our Company will be locked-in for a period of one year from the date of Allotment except (i) the Offered Shares which

are successfully transferred as part of the Offer for Sale; (ii) the Equity Shares held by Client Ebene Limited and CVCIGP II Employee Ebene Limited who are SEBI registered FVCIs; and (iii) Equity Shares held by the employees of the Company (whether currently an employee or not) which have been or will be allotted to them under ESOP 2015 and ESOP 2018. Any unsubscribed portion of the Offered Shares would also be locked in as required under the SEBI ICDR Regulations.

(d) *Other requirements in respect of lock-in:*

Further, pursuant to Regulation 22 of the SEBI ICDR Regulations, Equity Shares held by our Promoters, which are locked-in in accordance with Regulation 16 of the SEBI ICDR Regulations, may be transferred to any member of the Promoter Group, or to a new promoter or persons in control of our Company subject to continuation of the lock-in in the hands of the transferee for the remaining period and compliance with the Takeover Regulations, as applicable and such transferee shall not be eligible to transfer them till the lock-in period stipulated in SEBI ICDR Regulations has expired.

(e) *Lock-in of Equity Shares Allotted to Anchor Investors:*

Any Equity Shares Allotted to Anchor Investors under the Anchor Investor Portion shall be locked-in for a period of 30 days from the date of Allotment. As required under Regulation 20 of the SEBI ICDR Regulations, our Company shall ensure that the details of the Equity Shares locked-in are recorded by the relevant Depository

6. Shareholding Pattern of our Company

The table below presents the equity shareholding pattern of our Company as on the date of this Red Herring Prospectus.

Category (I)	Category of shareholder (II)	Number of shareholders (III)	Number of fully paid-up Equity Shares held (IV)	Number of partly paid-up Equity Shares held (V)	Number of shares underlying Depository Receipts (VI)	Total number of shares held (VII) = (IV)+(V)+(VI)	Shareholding as a % of total number of shares (calculated as per SCRR, 1957) (VIII) As a % of (A+B+C2)	Number of Voting Rights held in each class of securities (IX)		Number of shares underlying outstanding convertible securities (including warrants) (X)	Shareholding, as a % assuming full conversion of convertible securities (as a percentage of diluted share capital) (XI) = (VII)+(X) As a % of (A+B+C2)	Number of locked in shares (XII)		Number of Shares pledged or otherwise encumbered (XIII)		Number of Equity Shares held in dematerialized form (XIV)	
								Number of Voting Rights	Total as a % of (A+B+ C)			Number (a)	As a % of total Shares held (b)	Number (a)	As a % of total Shares held (b)		
								Class: Equity Shares	Total								
(A)	Promoters and Promoter Group	6	22,558,375*			22,558,375	43.91	22,558,375	22,558,375	43.91							22,558,375
(B)	Public	5	28,819,475			28,819,475	56.09	28,819,475	28,819,475	56.09							27,565,225
(C)	Non Promoters-Non Public	-	-	-	-	-	-	-	-	-	-	-	-	-	-	-	-
(C1)	Shares underlying DRs	-	-	-	-	-	-	-	-	-	-	-	-	-	-	-	-
(C2)	Shares held by Employee Trusts	-	-	-	-	-	-	-	-	-	-	-	-	-	-	-	-
	Total	11	51,377,850			51,377,850	100.00	51,377,850	51,377,850	100.00							50,123,600

*Pursuant to the provisions of a memorandum of understanding executed between FATHERAJ SINGHVI and the SINGHVI FAMILY SHAREHOLDERS, dated May 15, 2013, FATHERAJ SINGHVI is acting in trust in relation to 2,030,000 Equity Shares held by the SINGHVI FAMILY SHAREHOLDERS.

7. Details of equity shareholding of the major Shareholders of our Company

- (a) The Shareholders holding 1% or more of the paid-up Equity Share capital of our Company, on a fully diluted basis, as on the date of this Red Herring Prospectus are set forth below:

S. No.	Name of the Shareholder	No. of Equity Shares [^]	(%) of total shareholding [^]	No. of Equity Shares on a fully diluted basis [*]	(%) on a fully diluted basis [*]
1.	Client Ebene Limited	18,190,250	35.40	18,190,250	33.85
2.	Subramonia Sekhar Vasan	12,307,600	23.96	12,307,600	22.90
3.	CVCIGP II Employee Ebene Limited	10,188,425	19.83	10,188,425	18.96
4.	Unni Rajagopal Kothenath	3,416,925	6.65	3,416,925	6.36
5.	Fatheraj Singhvi ^{**}	3,366,925	6.55	3,366,925	6.27
6.	Devappa Devaraj	2,747,750	5.35	2,747,750	5.11
7.	Devappa Devaraj HUF	669,175	1.30	669,175	1.25

[^]Based on the beneficiary position statement dated September 3, 2021.

^{*}Assuming exercise of vested employee stock options

^{**}Pursuant to the provisions of a memorandum of understanding executed between Fatheraj Singhvi and the Singhvi Family Shareholders, dated May 15, 2013, Fatheraj Singhvi is acting in trust in relation to 2,030,000 Equity Shares held by the Singhvi Family Shareholders.

- (b) The Shareholders holding 1% or more of the paid-up Equity Share capital of our Company, on a fully diluted basis, as of the 10 days prior to the date of this Red Herring Prospectus are set forth below:

S. No.	Name of the Shareholder	No. of Equity Shares [^]	(%) of total shareholding [^]	No. of Equity Shares on a fully diluted basis [*]	(%) on a fully diluted basis [*]
1.	Client Ebene Limited	15,343,900	32.69	18,190,250	33.85
2.	Subramonia Sekhar Vasan	12,307,600	26.22	12,307,600	22.90
3.	CVCIGP II Employee Ebene Limited	8,593,425	18.31	10,188,425	18.96
4.	Unni Rajagopal Kothenath	3,416,925	7.28	3,416,925	6.36
5.	Fatheraj Singhvi ^{**}	3,366,925	7.17	3,366,925	6.27
6.	Devappa Devaraj	2,747,750	5.85	2,747,750	5.11
7.	Devappa Devaraj HUF	669,175	1.43	669,175	1.25

[^]Based on the beneficiary position statement dated August 27, 2021.

^{*}Assuming conversion of the Series A CCPS and Series B CCPS, exercise of vested employee stock options

^{**}Pursuant to the provisions of a memorandum of understanding executed between Fatheraj Singhvi and the Singhvi Family Shareholders, dated May 15, 2013, Fatheraj Singhvi is acting in trust in relation to 2,030,000 Equity Shares held by the Singhvi Family Shareholders.

- (c) The Shareholders holding 1% or more of the paid-up Equity Share capital of our Company, on a fully diluted basis, as of one year prior to the date of this Red Herring Prospectus are set forth below:

S. No.	Name of the Shareholder	No. of Equity Shares [^]	(%) of total shareholding [^]	No. of Equity Shares on a fully diluted basis [*]	(%) on a fully diluted basis [*]
1.	Client Ebene Limited	15,343,900	32.69	18,190,250	33.76
2.	Subramonia Sekhar Vasan	12,307,600	26.22	12,307,600	22.84
3.	CVCIGP II Employee Ebene Limited	8,593,425	18.31	10,188,425	18.91
4.	Unni Rajagopal Kothenath	3,416,925	7.28	3,416,925	6.34
5.	Fatheraj Singhvi ^{**}	3,416,925	7.28	3,416,925	6.34
6.	Devappa Devaraj ^{***}	3,416,925	7.28	3,416,925	6.34

[^]Based on the beneficiary position statement dated September 4, 2020.

^{*}Assuming conversion of the Series A CCPS and Series B CCPS, and exercise of vested employee stock options

^{**}Pursuant to the provisions of a memorandum of understanding executed between Fatheraj Singhvi and the Singhvi Family Shareholders, dated May 15, 2013, Fatheraj Singhvi is acting in trust in relation to 2,030,000 Equity Shares held by the Singhvi Family Shareholders.

^{***}Pursuant to the provisions of a memorandum of understanding executed between Devappa Devaraj and the Devappa Devaraj HUF, dated May 15, 2013, Devappa Devaraj was acting in trust in relation to 669,175 Equity Shares for the benefit of Devappa Devaraj (HUF).

- (d) The Shareholders holding 1% or more of the paid-up Equity Share capital of our Company, on a fully diluted basis, as of two years prior to the date of this Red Herring Prospectus are set forth below:

S. No.	Name of the Shareholder	No. of Equity Shares [^]	(%) of total shareholding [^]	No. of Equity Shares on a fully diluted basis*	(%) on a fully diluted basis*
1.	Client Ebene Limited	15,343,900	32.69	18,190,250	33.76
2.	Subramonia Sekhar Vasan	12,307,600	26.22	12,307,600	22.84
3.	CVCIGP II Employee Ebene Limited	8,593,425	18.31	10,188,425	18.91
4.	Unni Rajagopal Kothenath	3,416,925	7.28	3,416,925	6.34
5.	Fatheraj Singhvi **	3,416,925	7.28	3,416,925	6.34
6.	Devappa Devaraj ***	3,416,925	7.28	3,416,925	6.34

[^]Based on the beneficiary position statement dated September 6, 2019.

*Assuming conversion of the Series A CCPS and Series B CCPS, and exercise of vested employee stock options

**Pursuant to the provisions of a memorandum of understanding executed between Fatheraj Singhvi and the Singhvi Family Shareholders, dated May 15, 2013, Fatheraj Singhvi is acting in trust in relation to 2,030,000 Equity Shares held by the Singhvi Family Shareholders.

***Pursuant to the provisions of a memorandum of understanding executed between Devappa Devaraj and the Devappa Devaraj HUF, dated May 15, 2013, Devappa Devaraj was acting in trust in relation to 669,175 Equity Shares for the benefit of Devappa Devaraj (HUF).

8. Details of Equity Shares held by our Directors, Promoters, members of the Promoter Group and Key Managerial Personnel

- (i) Set out below are details of the Equity Shares held by our Directors and Key Managerial Personnel in our Company as on the date of this Red Herring Prospectus:

Name	No. of Equity Shares	Percentage of the pre- Offer Equity Share Capital on a fully diluted basis*(%)	Percentage of the post- Offer Equity Share Capital on a fully diluted basis* [^] (%)
Subramonia Sekhar Vasan	12,307,600	22.90	19.07
Fatheraj Singhvi **	3,366,925	6.27	5.20

*Assuming exercise of vested employee stock options

[^]The post- Offer Equity Share capital has been computed on a fully diluted basis, after taking into consideration the Equity Shares proposed to be sold by the Promoters in the Offer, and on the assumption that the Offer is fully subscribed. For further details of the portion of Offer Shares of the Promoters, see "The Offer" and "- Selling Shareholders' Shareholding in our Company" on pages 54 and 78, respectively.

**Pursuant to the provisions of a memorandum of understanding executed between Fatheraj Singhvi and the Singhvi Family Shareholders, dated May 15, 2013, Fatheraj Singhvi is acting in trust in relation to 2,030,000 Equity Shares held by the Singhvi Family Shareholders.

- (ii) Set out below are the details of the Equity Shares held by our Promoters and the members of our Promoter Group as on the date of the Red Herring Prospectus:

Name of the shareholder	No. of Equity Shares	Percentage (%) of the pre- Offer Equity Share Capital on a fully diluted basis*	Percentage of the post- Offer Equity Share Capital on a fully diluted basis (%)* [^]
Promoters			
Subramonia Sekhar Vasan	12,307,600	22.90	19.07
Unni Rajagopal Kothenath	3,416,925	6.36	5.30
Fatheraj Singhvi**	3,366,925 [^]	6.27	5.20
Devappa Devaraj	2,747,750	5.11	4.05
Total holding of the Promoters	21,839,200	40.64	33.62
Promoter Group			
Devappa Devaraj HUF	669,175	1.25	1.25
P. Singhvi Charitable Trust	50,000	0.09	0.09
Total holding of Promoter and Promoter Group*	22,558,375	41.98	34.96

*Assuming exercise of vested employee stock options

[^]The post- Offer Equity Share capital has been computed on a fully diluted basis, after taking into consideration the Equity Shares proposed to be sold by the Promoters in the Offer, and on the assumption that the Offer is fully subscribed. For further details of the portion of Offer Shares of the Promoters, see "The Offer" and "- Selling Shareholders' Shareholding in our Company" on pages 54 and 78, respectively.

**Pursuant to the provisions of a memorandum of understanding executed between Fatheraj Singhvi and the Singhvi Family Shareholders, dated May 15, 2013, Fatheraj Singhvi is acting in trust in relation to 2,030,000 Equity Shares held by the Singhvi Family Shareholders.

9. Selling Shareholders' Shareholding in our Company

The total number of Equity Shares held by the Selling Shareholders in our Company is as follows:

S. No.	Name of the Shareholder	No. of Equity Shares	(% of total shareholding)	No. of Equity Shares on a fully diluted basis*	(% on a fully diluted basis*	No. of Equity Shares on a fully diluted basis*	
						Pre-Offer	Post-Offer [^]
1.	Client Ebene Limited	18,190,250	35.40	18,190,250	33.85	9,554,842	17.78
2.	Subramonia Sekhar Vasani	12,307,600	23.96	12,307,600	22.90	10,249,531	19.07
3.	CVCIGP II Employee Ebene Limited	10,188,425	19.83	10,188,425	18.96	5,351,702	9.96
4.	Unni Rajagopal Kothanath	3,416,925	6.65	3,416,925	6.36	2,845,549	5.30
5.	Fatheraj Singhvi*	3,366,925	6.55	3,366,925	6.27	2,795,549	5.20
6.	Devappa Devaraj	2,747,750	5.35	2,747,750	5.11	2,176,374	4.05

*Assuming exercise of vested employee stock options

[^] The post-Offer Equity Share capital has been computed on a fully diluted basis, after taking into consideration the Equity Shares proposed to be sold by each Selling Shareholder in the Offer, and on the assumption that the Offer is fully subscribed.

**Pursuant to the provisions of a memorandum of understanding executed between Fatheraj Singhvi and the Singhvi Family Shareholders, dated May 15, 2013, Fatheraj Singhvi is acting in trust in relation to 2,030,000 Equity Shares held by the Singhvi Family Shareholders, and he is acting in trust for the offer for sale of up to 61,221 Equity Shares by Lalitha Singhvi, up to 62,031 Equity Shares by Praveen Singhvi, up to 62,031 Equity Shares by Lata Singhvi, up to 62,031 Equity Shares by Jayaraj Singhvi, up to 62,031 Equity Shares by Tara Singhvi and up to 62,031 Equity Shares by Indira Singhvi.

10. As on the date of this Red Herring Prospectus, the BRLMs and their respective associates (as defined under the Securities and Exchange Board of India (Merchant Bankers) Regulations, 1992) do not hold any Equity Shares of our Company. The BRLMs and their affiliates may engage in the transactions with and perform services for our Company in the ordinary course of business or may in the future engage in commercial banking and investment banking transactions with our Company for which they may in the future receive customary compensation.
11. There are no partly paid-up Equity Shares as on the date of this Red Herring Prospectus and all Equity Shares shall be fully paid-up at the time of Allotment.
12. **ESOP 2015**

The Company, pursuant to resolution passed by its shareholders dated April 13, 2015 has adopted the ESOP 2015. Further, the ESOP 2015 has been amended pursuant to resolutions passed by our Board on July 31, 2018, April 19, 2021 and August 22, 2021, respectively and by our Shareholders on August 3, 2018, June 2, 2021 and August 31, 2021, respectively. As per the ESOP 2015 the aggregate number of options may not exceed 3,463. Options under ESOP 2015 were granted to two groups viz. key management group at an exercise price of ₹100 per option (“**Program 1**”) and certain identified employees at an exercise price of ₹98,017 per option (“**Program 2**”). The number of options granted under Program 1 and Program 2 are 1,619 options, and 1,844 options, respectively. Further, pursuant to the Board and Shareholders resolution dated July 27, 2018 and July 28, 2018, respectively, every one equity share of face value ₹100 each was sub-divided into 50 Equity Shares of ₹2 each, and the Company has issued bonus shares of ₹2 each credited as fully paid-up shares to the holders of the existing Equity Shares of the Company in the proportion of 27 Equity Shares for every two existing Equity Shares held by the members. Accordingly, it was resolved in the aforesaid meetings that appropriate adjustments due to the sub-division of Equity Shares and issue of bonus shares (after adjusting for sub-division), to be made to the outstanding options granted to the employees of the Company under ESOP 2015, such that the exercise price for all outstanding options as on the ‘record date’ (as determined by the Board) (vested and unvested options, including lapsed and forfeited options available for reissue) shall be proportionately adjusted and the number of options which are available for grant and those already granted but not exercised as on ‘record date’ (as determined by the Board) shall be appropriately adjusted.

The details of ESOP 2015, are as follows:

Particulars	Total
Options granted	2,510,675
Options vested	2,362,050
Options exercised	Nil
Total number of Equity Shares that would arise as a result of full exercise of options granted (net of cancelled options)	2,510,675
Options forfeited/lapsed/cancelled	Nil
Money realised by exercise of options	Nil
Total number of options in force	2,510,675

Particulars	From April 1, 2021 till the date of this RHP	Fiscal 2021	Fiscal 2020	Fiscal 2019
Total Options outstanding	2,362,050	2,510,675	2,510,675*	3,463

Particulars	From April 1, 2021 till the date of this RHP	Fiscal 2021	Fiscal 2020	Fiscal 2019																								
at the beginning of the period	*During the Fiscals ended March 31, 2019, based on the shareholders' approval one equity share of ₹100 each was sub- divided into 50 equity shares of ₹2 each with effect from July 28, 2018. Subsequently, the Company had issued bonus shares in the proportion of 27 equity shares for every 2 equity shares held. The impact of subdivision and bonus was given to the outstanding options in FY 2019. The opening balance as on April 01, 2020 is after considering such impact.																											
Options granted	148,625* *During the Fiscal Year 2021 – 1,48,625 options were surrendered and reinstated in the ESOP 2015 pool. These options were subsequently granted on April 01, 2021, which will be 100% vested after one year from the date of grant.	Nil	Nil	Nil																								
Exercise Price (in ₹)	The weighted average exercise price under ESOP 2015 is ₹0.14 per option for Program 1 and ₹135.20 per option for Program 2.																											
Vesting Period	<p>Program 1: The entire stock options are completely vested.</p> <p>Program 2: The stock options outstanding as on March 31, 2021 are completely vested. The options granted from April 01, 2021 till the date of this certificate shall vest after one year from the date of grant.</p> <p>As per ESOP 2015 Scheme, Stock options under Program 2 issued carries different vesting years, it ranges from 25 to 100 percent vesting of total options granted by the end of every one year from the grant date. All stock options shall be fully vested by the end of 4 years from the grant date.</p>																											
Options vested and not exercised	2,362,050	2,362,050	2,510,675	2,510,675																								
Options exercised	Nil	Nil	Nil	Nil																								
The total number of Equity Shares arising as a result of exercise of options	Nil	Nil	Nil	Nil																								
Options forfeited/lapsed/surrendered	Nil	148,625	Nil	Nil																								
Variation of terms of options	<ul style="list-style-type: none"> Pursuant to the board and shareholders resolution dated August 22, 2021 and August 31, 2021, respectively, the ESOP 2015 was amended in order to ensure compliance with the SEBI (Shared Based Employee Benefits and Sweat Equity) Regulations, 2021 Pursuant to the board resolution dated July 27, 2018, the unvested options under ESOP 2015 as on July 27, 2018 was accelerated and got vested with effect from July 27, 2018. 																											
Money realized by exercise of options	Nil	Nil	Nil	Nil																								
Total number of options in force	2,510,675	2,362,050	2,510,675	2,510,675																								
	<i>*Options in Force = Options outstanding at the beginning + Options Granted during the period - Options lapsed or forfeited or surrendered during the period - Options exercised during the period.</i>																											
Employee-wise detail of options granted to:																												
i. Key managerial personnel	<table border="1"> <thead> <tr> <th>Name</th> <th>No. of Options</th> <th>Date of grant</th> </tr> </thead> <tbody> <tr> <td>Vikas Goel</td> <td>18,125</td> <td>April 1, 2021</td> </tr> <tr> <td>Rajesh Kumar Modi</td> <td>10,875</td> <td></td> </tr> <tr> <td>Total</td> <td>29,000</td> <td></td> </tr> </tbody> </table>	Name	No. of Options	Date of grant	Vikas Goel	18,125	April 1, 2021	Rajesh Kumar Modi	10,875		Total	29,000		Nil	Nil	Nil												
Name	No. of Options	Date of grant																										
Vikas Goel	18,125	April 1, 2021																										
Rajesh Kumar Modi	10,875																											
Total	29,000																											
ii. Any other employee who received a grant in any one year of options amounting to 5% or more of the options granted during the year	<table border="1"> <thead> <tr> <th>Name</th> <th>No. of Options</th> <th>Percentage of Options granted to the total options granted during the period</th> </tr> </thead> <tbody> <tr> <td>Vikas Goel</td> <td>18,125</td> <td>12.20%</td> </tr> <tr> <td>Deepak Soni</td> <td>21,750</td> <td>14.63%</td> </tr> <tr> <td>Jayakara Shetty</td> <td>10,875</td> <td>7.32%</td> </tr> <tr> <td>Rajesh Kumar Modi</td> <td>10,875</td> <td>7.32%</td> </tr> <tr> <td>Ravi Chandra K L</td> <td>10,875</td> <td>7.32%</td> </tr> <tr> <td>Jagdish Hasija</td> <td>21,750</td> <td>14.63%</td> </tr> <tr> <td>Sathish TR</td> <td>10,875</td> <td>7.32%</td> </tr> </tbody> </table>	Name	No. of Options	Percentage of Options granted to the total options granted during the period	Vikas Goel	18,125	12.20%	Deepak Soni	21,750	14.63%	Jayakara Shetty	10,875	7.32%	Rajesh Kumar Modi	10,875	7.32%	Ravi Chandra K L	10,875	7.32%	Jagdish Hasija	21,750	14.63%	Sathish TR	10,875	7.32%	Nil	Nil	Nil
Name	No. of Options	Percentage of Options granted to the total options granted during the period																										
Vikas Goel	18,125	12.20%																										
Deepak Soni	21,750	14.63%																										
Jayakara Shetty	10,875	7.32%																										
Rajesh Kumar Modi	10,875	7.32%																										
Ravi Chandra K L	10,875	7.32%																										
Jagdish Hasija	21,750	14.63%																										
Sathish TR	10,875	7.32%																										
iii. Identified employees who were granted options during any one year equal to or exceeding 1% of the issued capital (excluding outstanding warrants and conversions) of our Company at the time of grant	Nil																											
Fully diluted Earnings per Equity Share – (face value	NA	20.55	15.28	18.31																								

Particulars	From April 1, 2021 till the date of this RHP	Fiscal 2021	Fiscal 2020	Fiscal 2019																		
of ₹2 per Equity Share) pursuant to issue of Equity Shares on exercise of options calculated in accordance with the applicable accounting standard for 'Earnings per Share'																						
Lock-in	As per ESOP scheme, there is no lock-in.																					
Difference, if any, between employee compensation cost calculated using the intrinsic value of stock options and the employee compensation cost calculated on the basis of fair value of stock options and its impact on profits and on the Earnings per Equity Share – (face value ₹2 per Equity Share)	For the stock options outstanding as on March 31, 2021, there is no difference in the employee cost and earning per share as the share-based employee compensation is calculated as per fair value method in accordance with the Restated Consolidated Financial Information.																					
Description of the pricing formula method and significant assumptions used during the year to estimate the fair values of options, including weighted-average information, namely, risk-free interest rate, expected life, expected volatility, expected dividends and the price of the underlying share in market at the time of grant of the option	<p>Following method and assumptions were used for computing the weighted average fair value as per the Restated Consolidated Financial Information:</p> <p>The Black Scholes valuation model has been used for computing the fair value of the stock options:</p> <table border="1"> <thead> <tr> <th>Particulars</th> <th>For Program 1 Options</th> <th>For Program 2 Options</th> </tr> </thead> <tbody> <tr> <td>Weighted average exercise price (₹)</td> <td>₹0.14</td> <td>₹135.20</td> </tr> <tr> <td>Weighted average share price (₹)</td> <td>₹103.48</td> <td>₹103.48</td> </tr> <tr> <td>Expected volatility</td> <td>49.20%</td> <td>49.20%</td> </tr> <tr> <td>Expected term</td> <td>6.50 years</td> <td>6.50 years</td> </tr> <tr> <td>Risk free interest rate</td> <td>7.90%</td> <td>7.90%</td> </tr> </tbody> </table>				Particulars	For Program 1 Options	For Program 2 Options	Weighted average exercise price (₹)	₹0.14	₹135.20	Weighted average share price (₹)	₹103.48	₹103.48	Expected volatility	49.20%	49.20%	Expected term	6.50 years	6.50 years	Risk free interest rate	7.90%	7.90%
Particulars	For Program 1 Options	For Program 2 Options																				
Weighted average exercise price (₹)	₹0.14	₹135.20																				
Weighted average share price (₹)	₹103.48	₹103.48																				
Expected volatility	49.20%	49.20%																				
Expected term	6.50 years	6.50 years																				
Risk free interest rate	7.90%	7.90%																				
Impact on profit and Earnings per Equity Share – (face value ₹2 per Equity Share) of the last three years if the accounting policies prescribed in the SEBI SBEB Regulations had been followed in respect of options granted in the last three years	The Company has complied with the accounting standard issued by The Institute of Chartered Accountants of India which is in line with SEBI (Share Based Employee Benefits and Sweat Equity) Regulations 2021, as amended.																					
Intention of the key managerial personnel and whole-time directors who are holders of equity shares allotted on exercise of options granted under an employee stock option scheme or allotted under an employee stock purchase scheme, to sell their equity shares within three months after the date of listing of the equity shares in the initial public offer (aggregate number of equity shares intended to be sold by the holders of options), if any. In case of an employee stock option scheme, this information same shall be disclosed regardless of whether the equity shares arise out of options exercised before or after the initial public offer.	Six Key Managerial Personnel are intending to sell equity shares arising out of exercise of 224,000 options within the period of 3 months from the date of listing.																					

Particulars	From April 1, 2021 till the date of this RHP	Fiscal 2021	Fiscal 2020	Fiscal 2019	
Intention to sell equity shares arising out of an employee stock option scheme or allotted under an employee stock purchase scheme within three months after the date of listing, by directors, senior managerial personnel and employees having equity shares issued under an employee stock option scheme or employee stock purchase scheme amounting to more than one per cent. of the issued capital (excluding outstanding warrants and conversions), which inter-alia shall include name, designation and quantum of the equity shares issued under an employee stock option scheme or employee stock purchase scheme and the quantum they intend to sell within three months.					
	Name	Designation	Quantum of options granted under the ESOP -2015 Scheme	Quantum of shares intended to sell within 3 months after the date of listing	
	B.R. Preetham	Group CEO	754,000	115,000	
Praveen Chauhan	VP - Operations	501,700	50,000		

13. ESOP 2018

The Company, pursuant to resolution passed by its shareholders dated August 8, 2018 has adopted the ESOP 2018. Further, the ESOP 2018 has been amended pursuant to resolutions passed by our Board on April 19, 2021 and August 22, 2021 and Shareholders on June 2, 2021 and August 31, 2021, respectively. The aggregate number of options, which may be issued under ESOP 2018, shall be decided by the Nomination and Remuneration Committee and shall not exceed such number of options which represents 2.50% shareholding in our Company on a fully diluted basis (considering vesting of existing employee stock options as of the date of the ESOP 2018) as on the date of the ESOP 2018. The Nomination and Remuneration Committee may grant upto 60% of the aforesaid options (representing 1.50% of the shareholding in our Company) post filing of the Prospectus with the RoC and prior to listing of the Equity Shares on the Stock Exchanges, pursuant to the Offer. The balance options shall be reserved for future and shall be granted from time to time, post completion of the Offer.

As on the date of this Red Herring Prospectus, no options have been granted by our Company under ESOP 2018.

14. Other than as disclosed below, none of the members of our Promoter Group, our Directors or their relatives have purchased or sold any securities of our Company during the period of six months immediately preceding the date of filing of this Red Herring Prospectus:

Date of allotment/transfer	Nature of transaction	No. of equity shares	Nature of consideration	Face value per equity share (₹)	Issue/Acquisition/Transfer price per equity share (₹)
March 30, 2021	Transfer of Equity Shares from Devappa Devaraj to Devappa Devaraj HUF	669,175	NA	2	Nil
April 27, 2021	Transfer of Equity Shares from FATHERAJ Singhvi to P. Singhvi Charitable Trust	50,000	NA	2	Nil

15. As of the date of the filing of this Red Herring Prospectus, the total number of our Shareholders is 11.
16. None of our Company or our Directors have entered into any buy-back and/ or standby arrangements for purchase of Equity Shares from any person. Further, the BRLMs have not made any buy-back and/ or standby arrangements for purchase of Equity Shares from any person.
17. An oversubscription to the extent of 1% of the net Offer can be retained for the purposes of rounding off to the nearest

multiple of minimum Allotment lot while finalising the Basis of Allotment in accordance with SEBI ICDR Regulations.

18. Except for the Equity Shares that will be issued pursuant to the exercise of employee stock options granted under ESOP 2015 and ESOP 2018, there will be no further issue of Equity Shares whether by way of issue of bonus shares, rights issue, preferential issue or any other manner during the period commencing from the date of filing of this Red Herring Prospectus until the listing of the Equity Shares on the Stock Exchanges pursuant to the Offer.
19. Our Company presently does not intend or propose or is under negotiation or consideration to alter its capital structure for a period of six months from the Bid/ Offer Opening Date, by way of split or consolidation of the denomination of Equity Shares or further issue of Equity Shares (including issue of securities convertible into or exchangeable, directly or indirectly for Equity Shares) whether on a preferential basis or by way of issue of bonus shares or on a rights basis or by way of further public issue of Equity Shares or qualified institutions placements or otherwise. However, if our Company enters into acquisitions, joint ventures or other arrangements, our Company may, subject to necessary approvals, consider raising additional capital to fund such activity or use Equity Shares as currency for acquisitions or participation in such joint ventures. Provided, however, that the foregoing restrictions do not apply to: (a) the issuance of any Equity Shares under this Offer; and (b) the issuance of Equity Shares to employees pursuant to the ESOP 2015 and ESOP 2018.
20. There have been no financing arrangements whereby the members of our Promoter Group, our Directors, and their relatives have financed the purchase by any other person of securities of our Company other than in the normal course of the business of the financing entity, during a period of six months preceding the date of filing of this Red Herring Prospectus.
21. Our Promoters (except to the extent of sale of its Equity Shares) and members of our Promoter Group will not submit Bids, or otherwise participate in the Offer.
22. No person connected with the Offer, including, but not limited to, the BRLMs, our Company, the Selling Shareholders, Promoters, members of our Promoter Group, the members of the Syndicate, our Company or the Directors shall offer any incentive, whether direct or indirect, in any manner, whether in cash or kind or services or otherwise to any Bidder for making a Bid.
23. Our Company shall ensure that transactions in the Equity Shares by the Promoters and the members of the Promoter Group between the date of filing this Red Herring Prospectus with the RoC and the Bid/Offer Closing Date, if any, shall be reported to the Stock Exchanges within 24 hours of such transaction.
24. Except for exercise of employee stock options granted pursuant to ESOP 2015 and ESOP 2018, there are no outstanding convertible securities or any other right which would entitle any person any option to receive Equity Shares, as on the date of this Red Herring Prospectus.

OBJECTS OF THE OFFER

The objects of the Offer are to (i) to carry out the Offer for Sale of up to 17,244,328 Equity Shares by the Selling Shareholders; and (ii) achieve the benefits of listing the Equity Shares on the Stock Exchanges. Our Company will not receive any proceeds from the Offer and all such proceeds (net of any Offer related expenses to be borne by the Selling Shareholders) will go to the Selling Shareholders. For details of the Selling Shareholders and the number of Equity Shares offered by each Selling Shareholder in the Offer see “*The Offer*” on page 54.

Further, our Company expects that listing of the Equity Shares will enhance our visibility and brand image and provide liquidity to our Shareholders and will also provide a public market for the Equity Shares in India.

Utilisation of the Net Offer Proceeds by Selling Shareholders

Our Company will not directly receive any proceeds from the Offer (the “**Offer Proceeds**”) and all the Offer Proceeds will be received by the Selling Shareholders, in proportion to the Offered Shares sold by the respective Selling Shareholders as part of the Offer. For details of Offered Shares by each Selling Shareholder, see “*Other Regulatory and Statutory Disclosures*” on page 324.

Offer related expenses

The total expenses of the Offer are estimated to be approximately ₹[●] million. The Offer related expenses include fees payable to the BRLMs and legal counsels, fees payable to the auditors, brokerage and selling commission, underwriting commission, commission payable to Registered Brokers, SCSBs’ fees, Registrar’s fees, printing and stationery expenses, advertising and marketing expenses and all other incidental and miscellaneous expenses for listing the Equity Shares on the Stock Exchanges. Other than listing fees; audit fees of the Statutory Auditor (to the extent not attributable to the Offer); expenses for any product or corporate advertisements (to the extent not attributable to the Offer), which will be borne by the Company, and fees and expenses in relation to the legal counsel to the Selling Shareholders which shall be borne by the respective Selling Shareholders, all costs, charges, fees and expenses associated with and incurred in connection with the Offer shall be shared among each of the Selling Shareholders in proportion to the number of Equity Shares sold by them in the Offer, in accordance with the applicable law

The estimated Offer related expenses are as under:

Activity	Estimated Offer expenses ⁽¹⁾ (₹ in million)	As a % of the total estimated Offer expenses ⁽¹⁾	As a % of the total Offer size ⁽¹⁾
BRLMs’ fees and commissions (including underwriting commission, brokerage and selling commission)	[●]	[●]	[●]
Selling commission/processing fee for SCSBs and Bankers to the Offer and fee payable to the Sponsor Bank for Bids made by RIBs using UPI ⁽²⁾	[●]	[●]	[●]
Brokerage and selling commission and bidding charges for Members of the Syndicate, Registered Brokers, RTAs and CDPs ⁽³⁾⁽⁴⁾	[●]	[●]	[●]
Fees payable to the Registrar to the Offer	[●]	[●]	[●]
Fees payable to the other advisors to the Offer	[●]	[●]	[●]
Others			
- Listing fees, SEBI filing fees, upload fees, the Stock Exchanges processing fees, book building software fees and other regulatory expenses	[●]	[●]	[●]
- Printing and stationery	[●]	[●]	[●]
- Advertising and marketing expenses	[●]	[●]	[●]
- Fee payable to legal counsels	[●]	[●]	[●]
- Miscellaneous	[●]	[●]	[●]
Total estimated Offer expenses	[●]	[●]	[●]

⁽¹⁾ Amounts will be finalised and incorporated in the Prospectus on determination of Offer Price

⁽²⁾ Selling commission payable to the SCSBs on the portion for Retail Individual Bidders, Eligible Employees and Non-Institutional Investors which are directly procured by the SCSBs, would be as follows:

Portion for Retail Individual Investors*	0.35% of the Amount Allotted* (plus applicable taxes)
Portion for Eligible Employees*	0.25% of the Amount Allotted* (plus applicable taxes)
Portion for Non-Institutional Investors*	0.20% of the Amount Allotted* (plus applicable taxes)

*Amount Allotted is the product of the number of Equity Shares Allotted and the Offer Price

⁽³⁾ No additional uploading/processing fees shall be payable by our Company to the SCSBs on the Bid cum Applications Forms directly procured by them. The Selling Commission payable to the SCSBs will be determined on the basis of the bidding terminal id as captured in the bid book of BSE or NSE. Processing fees payable to the SCSBs on the portion for Retail Individual Bidders, Eligible Employees and Non-Institutional Bidders which are procured by the members of the Syndicate/sub-Syndicate members/Registered Broker/RTAs/ CDPs and submitted to SCSB for blocking, would be as follows:

Portion for Retail Individual Investors*	₹10 per valid Bid cum Application Form (plus applicable taxes)
Portion for Eligible Employees*	₹10 per valid Bid cum Application Form (plus applicable taxes)
Portion for Non-Institutional Investors*	₹10 per valid Bid cum Application Form (plus applicable taxes)

*Amount Allotted is the product of the number of Equity Shares Allotted and the Offer Price

- (4) For Syndicate (including their Sub-Syndicate Members), RTAs and CDPs **Brokerages, selling commission and processing/uploading charges** on the portion for Retail Individual Bidders (using the UPI mechanism) and portion for Non-Institutional Bidders and Eligible Employees which are procured by members of Syndicate (including their Sub-Syndicate Members), RTAs and CDPs or for using 3-in-1 type accounts- linked online trading, demat & bank account provided by some of the brokers which are members of Syndicate (including their Sub-Syndicate Members) would be as follows:

Portion for Retail Individual Bidders	0.35% of the Amount Allotted* (plus applicable taxes)
Portion for Non-Institutional Bidders	0.20% of the Amount Allotted* (plus applicable taxes)
Portion for Eligible Employees	0.25% of the Amount Allotted* (plus applicable taxes)

*Amount Allotted is the product of the number of Equity Shares Allotted and the Offer Price

The Selling Commission payable to the Syndicate / Sub-Syndicate Members will be determined on the basis of the application form number / series, provided that the application is also bid by the respective Syndicate / Sub-Syndicate Member. For clarification, if a Syndicate ASBA application on the application form number / series of a Syndicate / Sub-Syndicate Member, is bid by an SCSB, the Selling Commission will be payable to the SCSB and not the Syndicate / Sub-Syndicate Member.

The payment of Selling Commission payable to the sub-brokers / agents of Sub-Syndicate Members are to be handled directly by the respective Sub-Syndicate Member.

The Selling Commission payable to the RTAs and CDPs will be determined on the basis of the bidding terminal id as captured in the bid book of BSE or NSE.

- (5) **Uploading Charges/ Processing Charges of Rs. 30/- per valid application** (plus applicable taxes) are applicable only in case of bid uploaded by the members of the Syndicate, RTAs and CDPs: for applications made by Retail Individual Investors using the UPI Mechanism
- (6) **Uploading Charges/ Processing Charges of Rs. 10/- per valid application** (plus applicable taxes) are applicable only in case of bid uploaded by the members of the Syndicate, RTAs and CDPs: for applications made by Retail Individual Bidders using 3-in-1 type accounts, for applications made by Non-Institutional Bidders using Syndicate ASBA mechanism / using 3-in-1 type accounts, for applications made by Eligible Employees using 3-in-1 type accounts
- (7) The Bidding/uploading charges payable to the Syndicate / Sub-Syndicate Members, RTAs and CDPs will be determined on the basis of the bidding terminal id as captured in the bid book of BSE or NSE.

(8) For Registered Brokers

Selling commission payable to the registered brokers on the portion for Retail Individual Bidders, Non-Institutional Bidders and Eligible Employees which are directly procured by the Registered Brokers and submitted to SCSB for processing would be as follows:

Portion for Retail Individual Bidders, Non-Institutional Bidders and Eligible Employees	Rs. 10/- per valid application* (plus applicable taxes)
---	---

*Based on valid applications

(9) For Sponsor Bank

Processing fees for applications made by Retail Individual Bidders using the UPI Mechanism will be

Sponsor Bank	Nil/- per valid Bid cum Application Form
	The Sponsor Bank shall be responsible for making payments to the third parties such as remitter bank, NPCI and such other parties as required in connection with the performance of its duties under the SEBI circulars, the Syndicate Agreement and other applicable laws.

Monitoring of Utilisation of Funds

As the Offer is an offer for sale of Equity Shares by the Selling Shareholders, our Company will not receive any proceeds from the Offer. Accordingly, no monitoring agency is appointed for the Offer.

Other Confirmations

Except to the extent of any proceeds received pursuant to the sale of Equity Shares proposed to be sold by the Selling Shareholders, none of our Promoters, Directors, Key Managerial Personnel, Promoter Group or Group Companies will receive any portion of the Offer Proceeds.

BASIS FOR OFFER PRICE

The Offer Price will be determined by our Company in consultation with the BRLMs and the Selling Shareholders, on the basis of assessment of market demand for the Equity Shares offered through the Book Building Process and on the basis of quantitative and qualitative factors as described below. The face value of the Equity Shares is ₹2 each and the Offer Price is [●] times the Floor Price and [●] times the Cap Price of the Price Band. Bidders should also see “Our Business”, “Risk Factors”, “Management’s Discussion and Analysis of Financial Condition and Results of Operations” and “Financial Statements” on pages 147, 22, 282 and 219, respectively, to have an informed view before making an investment decision.

Qualitative Factors

Some of the qualitative factors and our strengths which form the basis for computing the Offer Price are:

- Leading supplier of complex and high-quality precision engineered components that is gaining market share across automotive and non-automotive sectors;
- Well diversified business model;
- Capabilities in engineering and design, machine building and automation resulting in continuous new product development and improved productivity, with fungibility of equipment, machinery and production lines across product families and sectors;;
- Long-standing relationships with well-known Indian and global OEM customers;
- Financial performance that has outperformed the industry trends, with industry leading metrics; and
- Skilled and experienced board of directors and management team, with an employee culture that emphasises teamwork and collaboration across functions

For details, see “Our Business – Our Strengths” on page 149.

Quantitative Factors

Some of the information presented below relating to our Company is derived from the Restated Consolidated Financial Information. For details, see “Financial Statements” on page 219.

Some of the quantitative factors which may form the basis for computing the Offer Price are as follows:

A. Basic and Diluted Earnings Per Share (“EPS”) at face value of ₹2, as adjusted for change in capital:

Fiscal ended	Basic EPS (in ₹)	Diluted EPS (in ₹)	Weight
March 31, 2021	21.02	20.55	3
March 31, 2020	15.63	15.28	2
March 31, 2019	18.73	18.31	1
Weighted Average	18.84	18.42	

Notes:

- 1) Weighted average is aggregate of year-wise weighted EPS divided by the aggregate of weights i.e. $\{(EPS \times Weight) \text{ for each year} / \{Total \text{ of weights}\}$
- Weighted average number of equity shares is the number of equity shares outstanding at the beginning of the year adjusted by the number of equity shares issued during the year multiplied by the time weighting factor. The time weighting factor is the number of days for which the specific shares are outstanding as a proportion of total number of days during the year.
- 2) The face value of equity shares of the Company is ₹2.
- 3) EPS has been calculated in accordance with the Indian Accounting Standard 33 – “Earnings per share”.
- 4) Basic EPS is calculated as Profit for the year attributable to owners of the company divided by the weighted average number of basic equity shares outstanding during the year. Basic equity shares is calculated as current shares outstanding and shares to be issued upon conversion of Series A CCPS and Series B CCPS
- 5) Diluted EPS is calculated as Profit for the year attributable to owners of the company divided by the weighted average number of diluted equity shares outstanding during the year. Diluted equity shares is calculated as current shares outstanding and shares to be issued upon conversion of Series A CCPS and Series B CCPS and other potentially dilutive instruments
- 6) The weights for calculation of EPS for each financial year has been decided by the management of the Company

For details, see “Other Financial Information” on page 280.

B. Price/Earning (“P/E”) ratio in relation to the Price Band of ₹[●] to ₹[●] per Equity Share:

Particulars	P/E at the lower end of the Price Band (no. of times)	P/E at the higher end of the Price Band (no. of times)
Based on basic EPS for year ended March 31, 2021	[●]	[●]
Based on diluted EPS for year ended March 31, 2021	[●]	[●]

Industry Peer Group P/E ratio

Particulars	Industry P/E
Highest	95.7
Lowest	n.a.

Particulars	Industry P/E
Average	62.0

Note: The industry high and low has been considered from the industry peer set provided later in this section.

C. Return on Net Worth (“RoNW”)

Fiscal ended	RoNW (%)	Weight
March 31, 2021	12.31%	3
March 31, 2020	10.47%	2
March 31, 2019	14.05%	1
Weighted Average	11.98%	

Notes:

- 1) Return on Net worth is calculated as Profit attributable to owners of the company divided by Net worth. Net worth is calculated as Total equity attributable to owners of the company less Capital reserve. For details, see “Other Financial Information” on page 280
- 2) Weighted average is aggregate of year-wise weighted RoNW divided by the aggregate of weights i.e. $\{(RoNW \times Weight) \text{ for each year}\} / \{\text{Total of weights}\}$
- 3) The weights for calculation of RoNW for each financial year has been decided by the management of the Company.

For details, see “Other Financial Information” on page 280.

As the Offer consists only of an offer for sale by the Selling Shareholders, there will be no change in the Net Worth post completion of the Offer.

D. Net Asset Value (“NAV”) per Equity Share

As at	Basic NAV per Equity Share (in ₹)	Diluted NAV per Equity Share (in ₹)
March 31, 2021	170.78	166.96
March 31, 2020	149.36	146.02
March 31, 2019	133.24	130.27

* As per the Restated Financial Information.

Notes:

- 1) Basic Net Asset Value per share is calculated as Net worth divided by the weighted average number of basic equity shares outstanding during the year. Basic equity shares is calculated as current shares outstanding and shares to be issued upon conversion of Series A CCPS and Series B CCPS
- 2) Diluted Net Asset Value per share is calculated as Net worth divided by the weighted average number of diluted equity shares outstanding during the year. Diluted equity shares is calculated as current shares outstanding and shares to be issued upon conversion of Series A CCPS and Series B CCPS and other potentially dilutive instruments

For details, see “Other Financial Information” on page 280.

As the Offer consists only of an offer for sale by the Selling Shareholders, there will be no change in the NAV post completion of the Offer.

E. Comparison with Listed Industry Peers

The following peer group has been determined on the basis of companies listed on Indian stock exchanges, whose business profile is comparable to our businesses:

Name of Company	Face Value (₹ per Share)	Revenue, for Fiscal 2021 (Total Income) (₹ in million)	EPS, for Fiscal 2021 (₹)		NAV, as on March 31, 2021 ⁽⁴⁾ (₹ per share)	P/E ⁽¹⁾	P/B ⁽⁵⁾	RoNW, as on March 31, 2021 ⁽²⁾ (%)
			Basic	Diluted				
Sansera Engineering Limited	2	15,723.64*	21.02**	20.55#	166.96##	[•]	[•]	12.31
Listed peers								
Endurance Technologies Limited	10	65,777	36.95	36.95	253.2	43.1	6.3	14.59
Minda Industries Limited	2	64,208	7.73	7.41	94.3	95.7	7.9	9.69
Sundram Fasteners Limited	1	36,717	17.10	17.10	112.2	45.9	7.0	15.38
Suprajit Engineering Limited	1	16,744	10.20	10.20	70.8	34.2	4.9	14.42
Bharat Forge Limited	2	65,052	-2.71	-2.71	116.9	n.a.	6.9	-2.33
Motherson Sumi Systems Limited	1	5,75,992	3.29	3.29	52.5	65.1	4.1	9.46
Mahindra CIE Automotive Limited ⁽⁶⁾	10	61,050	2.8	2.8	129.5	87.8	1.9	2.00

*indicates Total income

**Basic EPS is calculated as Profit for the year attributable to owners of the company divided by the weighted average number of basic equity shares outstanding during the year. Basic equity shares is calculated as current shares outstanding and shares to be issued upon conversion of Series A CCPS and Series B CCPS

#Diluted EPS is calculated as Profit for the year attributable to owners of the company divided by the weighted average number of diluted equity shares outstanding during the year. Diluted equity shares is calculated as current shares outstanding and shares to be issued upon conversion of Series A CCPS and Series B CCPS and other potentially dilutive instruments

##indicates Diluted Net Asset Value per share which is calculated as Net worth divided by the weighted average number of diluted equity shares outstanding during the year. Diluted equity shares is calculated as current shares outstanding and shares to be issued upon conversion of Series A CCPS and Series B CCPS and other potentially dilutive instruments

^Return on Net worth is calculated as Profit attributable to owners of the company divided by Net worth. Net worth is calculated as Total equity attributable to owners of the company less Capital reserve. For details, see "Other Financial Information" on page 280

Source: All the financial information for listed industry peer mentioned above is on a consolidated basis and is sourced from the annual report of the company for the year ended March 31, 2021.

Notes:

- (1) P/E Ratio has been computed based on the closing market price of equity shares on BSE on August 19, 2021, divided by the Basic EPS.
- (2) RoNW is computed as net profit after tax (including profit attributable to non-controlling interest) divided by closing net worth.
- (3) Net worth has been computed as sum of paid-up share capital and other equity.
- (4) NAV is computed as the closing net worth divided by the closing outstanding number of equity shares.
- (5) P/B Ratio has been computed based on the closing market price of equity shares on BSE on August 19, 2021, divided by NAV as on March 31, 2021.
- (6) Numbers for Mahindra CIE Automotive Limited are as of December 31, 2020

F. The Offer Price is [•] times of the face value of the Equity Shares

The Offer Price of ₹[•] has been determined by our Company in consultation with the Selling Shareholders and the BRLMs, on the basis of market demand from investors for Equity Shares through the Book Building Process and is justified in view of the above qualitative and quantitative parameters.

Investors should read the above mentioned information along with "Risk Factors", "Our Business", "Management's Discussion and Analysis of Financial Condition and Results of Operations" and "Financial Statements" on pages 22, 147, 282 and 219, respectively, to have a more informed view.

The trading price of the Equity Shares could decline due to the factors mentioned in the "Risk Factors" on page 22 and you may lose all or part of your investment.

STATEMENT OF SPECIAL TAX BENEFITS

STATEMENT OF SPECIAL TAX BENEFITS AVAILABLE TO SANSERA ENGINEERING LIMITED (FORMERLY KNOWN AS SANSERA ENGINEERING PRIVATE LIMITED) (“THE COMPANY”) AND THE SHAREHOLDERS OF THE COMPANY UNDER THE DIRECT AND INDIRECT TAX LAWS IN INDIA

September 6, 2021

To

The Board of Directors

Sansera Engineering Limited (formerly known as Sansera Engineering Private Limited)

Plant-7, No.143/A, Jigani Link Road,

Bommasandra Industrial Area,

Anekal Taluk,

Bengaluru – 560105

Dear Sirs,

Sub: Statement of possible Special Tax Benefits available to the Company and its equity shareholders under the direct and indirect tax laws

We refer to the proposed initial public offering of equity shares (the “Offer”) of Sansera Engineering Limited (formerly known as “Sansera Engineering Private Limited”) (“Sansera” or the “Company”). We enclose herewith the statement (the “Annexure”) showing the current position of special tax benefits available to the Company and to its shareholders as per the provisions of the Indian direct and indirect tax laws including the Income-tax Act, 1961, the Central Goods and Services Tax Act, 2017, the Integrated Goods and Services Tax Act, 2017, the Union Territory Goods and Services Tax Act, 2017, respective State Goods and Services Tax Act, 2017 (collectively the “GST Act”), the Customs Act, 1962 (“Customs Act”) and the Customs Tariff Act, 1975 (“Tariff Act”) (collectively the “Taxation Laws”) including the rules, regulations, circulars and notifications issued in connection with the Taxation Laws, as presently in force and applicable to the assessment year 2022-23 relevant to the financial year 2021-22 for inclusion in the Red Herring Prospectus (“RHP”) and Prospectus (RHP and Prospectus collectively referred to as “Offer Documents”) for the proposed initial public offering of shares of the Company as required under the Securities and Exchange Board of India (Issue of Capital and Disclosure Requirements) Regulations, 2018, as amended (“ICDR Regulations”).

Several of these benefits are dependent on the Company or its shareholders fulfilling the conditions prescribed under the relevant provisions of the direct and indirect taxation laws including the Income-tax Act 1961. Hence, the ability of the Company or its shareholders to derive these direct and indirect tax benefits is dependent upon their fulfilling such conditions.

The benefits discussed in the enclosed Annexure are neither exhaustive nor conclusive. The contents stated in the Annexure are based on the information and explanations obtained from the Company. This statement is only intended to provide general information to guide the investors and is neither designed nor intended to be a substitute for professional tax advice. In view of the individual nature of the tax consequences and the changing tax laws, each investor is advised to consult their own tax consultants, with respect to the specific tax implications arising out of their participation in the Offer particularly in view of the fact that certain recently enacted legislation may not have a direct legal precedent or may have a different interpretation on the benefits, which an investor can avail. We are neither suggesting nor are we advising the investors to invest or not to invest money based on this statement.

The contents of the enclosed Annexure are based on the representations obtained from the Company and on the basis of our understanding of the business activities and operations of the Company.

We do not express any opinion or provide any assurance whether:

- The Company or its Shareholders will continue to obtain these benefits in future;
- The conditions prescribed for availing the benefits have been/would be met;
- The revenue authorities/courts will concur with the views expressed herein.

This statement is provided solely for the purpose of assisting the Company in discharging its responsibilities under the ICDR Regulations.

We hereby give our consent to include this report and the enclosed Annexure regarding the tax benefits available to the Company and its shareholders in the Offer Documents for the proposed initial public offer of equity shares which the Company intends to submit to the Securities and Exchange Board of India and the National Stock Exchange of India Limited and BSE Limited (the “Stock Exchanges”) where the equity shares of the Company are proposed to be listed, as applicable, provided that the below statement of limitation is included in the Offer Documents.

LIMITATIONS

Our views expressed in the enclosed Annexure are based on the facts and assumptions indicated above. No assurance is given that the revenue authorities/courts will concur with the views expressed herein. Our views are based on the information, explanations and representations obtained from the Company and on the basis of our understanding of the business activities and operations of the Company and the existing provisions of taxation laws in force in India and its interpretation, which are subject to change from time to time. We do not assume responsibility to update the views consequent to such changes. Reliance on the statement is on the express understanding that we do not assume responsibility towards the investors and third parties who may or may not invest in the initial public offer relying on the statement. This statement has been prepared solely in connection with the proposed initial public offering of equity shares of the Company under the ICDR Regulations.

For **Deloitte Haskins & Sells**
Chartered Accountants
(Firm's Registration No: 008072S)

Monisha Parikh

(Partner)
(Membership Number: 47840)
UDIN:21047840AAAADV6855

Place: Ahmedabad

Date: September 6, 2021

ANNEXURE TO THE STATEMENT OF SPECIAL TAX BENEFITS AVAILABLE TO SANSERA ENGINEERING LIMITED (FORMERLY KNOWN AS “SANSERA ENGINEERING PRIVATE LIMITED”) (“COMPANY”) AND COMPANY’S SHAREHOLDERS (“SHAREHOLDERS”)

The information provided below sets out the possible special direct and indirect tax benefits available to Sansera Engineering Limited (formerly known as “Sansera Engineering Private Limited”) (“Sansera” or “the Company”) and the shareholders of the Company in a summary manner only and is not a complete analysis or listing of all potential tax consequences of the subscription, ownership and disposal of equity shares of the Company, under the current Tax Laws presently in force in India. Several of these benefits are dependent on the shareholders fulfilling the conditions prescribed under the relevant Tax Laws. Hence, the ability of the shareholders to derive the tax benefits is dependent upon fulfilling such conditions, which, based on business / commercial imperatives a shareholder faces, may or may not choose to fulfill. We do not express any opinion or provide any assurance as to whether the Company or its shareholders will continue to obtain these benefits in future. The following overview is not exhaustive or comprehensive and is not intended to be a substitute for professional advice. In view of the individual nature of the tax consequences and the changing tax laws, each investor is advised to consult their own tax consultant with respect to the specific tax implications arising out of their participation in the issue. We are neither suggesting nor are we advising the investor to invest money or not to invest money based on this statement.

The statement below covers only relevant special direct and indirect tax law benefits and does not cover benefits under any other law.

INVESTORS ARE ADVISED TO CONSULT THEIR OWN TAX CONSULTANT WITH RESPECT TO THE TAX IMPLICATIONS OF AN INVESTMENT AND CONSEQUENCES OF PURCHASING, OWNING AND DISPOSING OF EQUITY SHARES IN THE SECURITIES, PARTICULARLY IN VIEW OF THE FACT THAT CERTAIN RECENTLY ENACTED LEGISLATION MAY NOT HAVE A DIRECT LEGAL PRECEDENT OR MAY HAVE A DIFFERENT INTERPRETATION ON THE BENEFITS, WHICH AN INVESTOR CAN AVAIL IN THEIR PARTICULAR SITUATION.

STATEMENT OF POSSIBLE SPECIAL DIRECT TAX BENEFITS AVAILABLE TO THE COMPANY AND SHAREHOLDERS OF THE COMPANY

I. Special direct tax benefits available to the Company

Deductions from Gross Total Income

- Deduction in respect of employment of new employees

Subject to the fulfilment of prescribed conditions, the Company is entitled to claim a deduction of an amount equal to thirty per cent of additional employee cost (relating to specified category of employees) incurred in the course of business in the previous year, for three assessment years including the assessment year relevant to the previous year in which such employment is provided under section 80JJAA of the Act.

We understand that the Company has opted for concessional tax rate under section 115BAA of the Act. However, the Company will still be eligible to claim the above deduction.

II. Special direct tax benefits available to Shareholders

Apart from the tax benefits available to each class of shareholders as such, there are no special tax benefits for shareholders.

NOTES:

1. The above benefits are as per the current tax law as amended by the Finance Act, 2021.
2. This statement does not discuss any tax consequences in the country outside India of an investment in the shares. The shareholders/investors in the country outside India are advised to consult their own professional advisors regarding possible Income tax consequences that apply to them.
3. The Company has opted for concessional tax rate under section 115BAA of the Act. Accordingly, the surcharge shall be levied at the rate of 10% irrespective of the amount of total income.
4. Health and Education Cess at 4% on the tax and surcharge is payable by all category of taxpayers.

5. The Company has opted for concessional tax rate under section 115BAA of the Act. Hence, it will not be allowed to claim any of the following deductions/exemptions:

- Deduction under the provisions of section 10AA (deduction for units in Special Economic Zone)
- Deduction under clause (iia) of sub-section (1) of section 32 (Additional depreciation)
- Deduction under section 32AD or section 33AB or section 33ABA (Investment allowance in backward areas, Investment deposit account, site restoration fund)
- Deduction under sub-clause (ii) or sub-clause (iia) or sub-clause (iii) of sub-section (1) or sub-section (2AA) or sub-section (2AB) of section 35 (Expenditure on scientific research)
- Deduction under section 35AD or section 35CCC (Deduction for specified business, agricultural extension project)
- Deduction under section 35CCD (Expenditure on skill development)
- Deduction under any provisions of Chapter VI-A other than the provisions of section 80JJAA (Deduction in respect of employment of new employees) and 80M (Deduction in respect of certain inter-corporate dividends);
- No set-off of any loss carried forward or depreciation from any earlier assessment year, if such loss or depreciation is attributable to any of the deductions referred above. However, if there is a depreciation allowance which has not been given full effect to before AY 2020-21, corresponding adjustment shall be made to the written down value of such block of assets as on the 1 April 2019 in the prescribed manner, if the option is exercised for AY 2020-21;
- No set-off of any loss or allowance for unabsorbed depreciation deemed so under section 72A, if such loss or depreciation is attributable to any of the deductions referred to in clause

The provisions of section 115JB regarding Minimum Alternate Tax (MAT) are not applicable. Further, such Company will not be entitled to claim tax credit relating to MAT.

STATEMENT OF SPECIAL INDIRECT TAX BENEFITS AVAILABLE TO THE COMPANY AND ITS SHAREHOLDERS

The Central Goods and Services Tax Act, 2017, the Integrated Goods and Services Tax Act, 2017, the Union Territory Goods and Services Tax Act, 2017, respective State Goods and Services Tax Act, 2017, the Customs Act, 1962 and the Customs Tariff Act, 1975 (collectively referred to as “Indirect tax”)

I. Special indirect tax benefits available to the Company

There are no special tax benefits available to the Company under the indirect tax laws.

II. Special indirect tax benefits available to Shareholders

There are no special tax benefits applicable in the hands of the shareholders for investing in the shares of the Company under the indirect tax laws.

SECTION IV: ABOUT OUR COMPANY

INDUSTRY OVERVIEW

Unless noted otherwise, the information in this section has been obtained or derived from the reports titled “Assessment of Indian Automotive and Precision Engineering Industry and Potential for Specific Forged and Machined Components” dated June 5, 2021 (the “**CRISIL Report**”) prepared by CRISIL Research, a division of CRISIL Limited (“**CRISIL Research**” or “**CRISIL**”), and “Global Industry Overview and Market Sizing of Specific Powertrain Components” dated June 4, 2021 (the “**Ricardo Report**”) prepared by Ricardo plc (“**Ricardo**”) – both of which were commissioned by our Company in connection with the Offer for an agreed fee. Further, the CRISIL Report and the Ricardo Report were prepared using information as of specific dates which may no longer be current or reflect current trends, and opinions in the CRISIL Report or the Ricardo Report may be based on estimates, projections, forecasts and assumptions that may prove to be incorrect. For more details, see “Risk Factors - Statistical and industry data in this Red Herring Prospectus are derived from the CRISIL Report and the Ricardo Report, both of which were commissioned by our Company for the purpose of the Offer for an agreed fee. Each of the CRISIL Report and the Ricardo Report is not exhaustive and is based on certain assumptions and parameters and conditions. The data and statistics in the CRISIL Report and the Ricardo Report may be inaccurate, incomplete or unreliable” on page 52.

Unless otherwise stated, all estimates, forecasts, projections, expectations and opinions in this section are those of CRISIL Research or Ricardo, as the case may be.

GLOBAL MACROECONOMIC OVERVIEW

(The following has been sourced from page 4 of the CRISIL Report).

The global economy is gradually getting back on its feet since the COVID-19 pandemic hit over a year ago. But the resurgence of COVID-19 cases in some countries has prompted authorities to re-impose lockdowns to contain its spread. Nevertheless, multiple vaccine approvals in December, the commencement of vaccination in some countries, and better-than-expected data on economic activity from various parts of the world have resulted in the International Monetary Fund (“**IMF**”) raising its estimates of world economic growth yet again in its April 2021 update of the World Economic Outlook.

IMF estimates of GDP growth for key economies

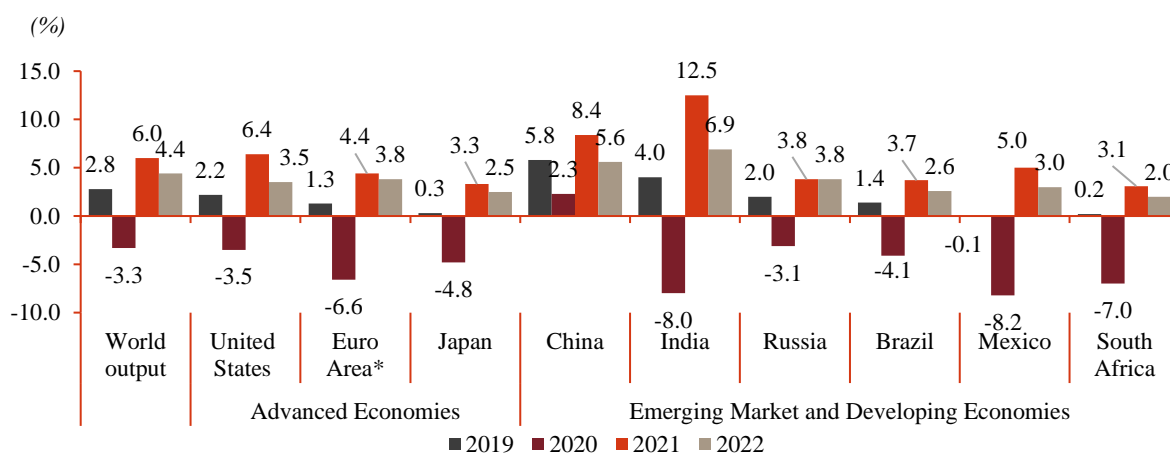

Note: Years represents Calendar Year, *Euro area includes Germany, France, Italy, Spain
Source: IMF

However, the IMF also raises a few lingering concerns that could derail the momentum seen in recent data points: surging infections for new variants of the virus and renewed lockdowns, logistical problems with vaccine distribution and uncertainty about vaccine uptake.

INDIA MACROECONOMIC OVERVIEW

(The following has been sourced from pages 6 to 19 of the CRISIL Report).

The Indian economy recorded a robust 6.7% CAGR over the Fiscal 2015 to 2020 period driven by rising consumer aspirations, rapid urbanization, the government’s focus on infrastructure investment and growth of domestic manufacturing sector. This economic growth was supported by benign crude oil prices, softer interest rates and lower current account deficit. The Indian government also undertook key reforms and initiatives such as the implementation of goods and services tax (“**GST**”), the Insolvency and Bankruptcy Code (“**IBC**”), the Make in India program, financial inclusion initiatives, gradual opening of sectors such as retail, e-commerce, defense, railways, and insurance for foreign direct investments (“**FDI**”). Growth over Fiscal 2018 to 2020 was hindered, however, by demonetisation, the NBFC crisis, GST implementation and slower global economic growth.

GDP growth review and outlook

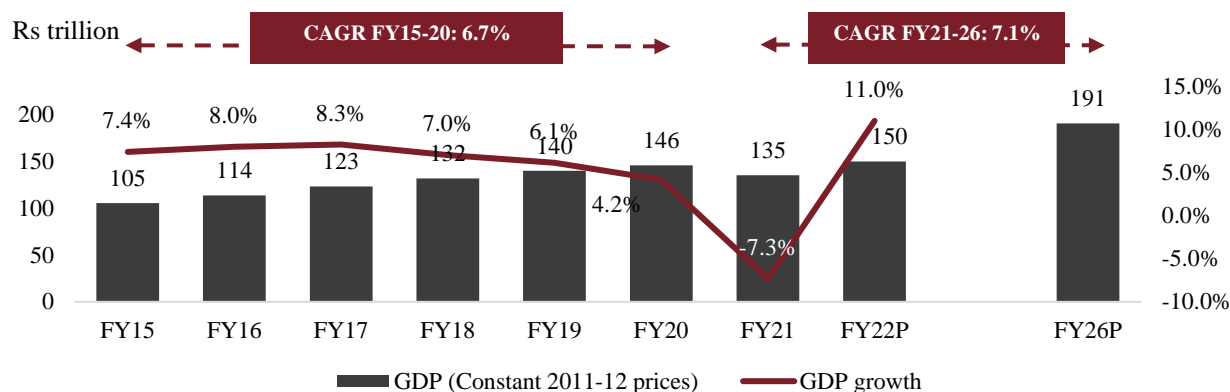

Note: P - Projected

Source: National Statistics Office (NSO), CRISIL Research estimates

After a steep contraction in the first half of this Fiscal, owing to the rising number of COVID-19 cases, GDP growth is estimated to have moved into positive territory towards the end of the Fiscal. India was showing some signs of recovery following a slew of fiscal/monetary measures before the pandemic struck for the first time in 2020. These measures are however expected to support India's economic recovery in Fiscal 2022. CRISIL foresees GDP growth rebounding to 11% in Fiscal 2022 over a low base of Fiscal 2021 supported by the government's vaccination drive, focus on infrastructure spends, global economic recovery and rising consumer confidence.

Risks to growth

Below par monsoons: Domestically, one major risk could be sub-normal monsoon this calendar year. The past two years have seen good rains and chances that they are normal this year are uncertain because only once in the past 20 years has India seen more than two consecutive normal monsoon years. A monsoon failure can directly shave up to approximately 50 basis points (bps) off from the Fiscal 2022 GDP growth forecast.

COVID-19 cases increasing: India seemed to have gotten COVID-19 cases under control, with the number of cases declining post September 2020. However, since the end of February 2021, India has been witnessing a surge in COVID-19 cases, leading to state governments taking steps to control the spread including imposing curfews and lockdowns, resulting in loss of economic output. During the second wave of COVID-19 cases, the number of total daily active cases had crossed the 400,000 mark for the first time in the first week of May. During the first week of June, the number of daily active cases had dropped sharply to under 140,000. The growth outlook for Fiscal 2022 will see a downward pressure if India faces a severe third wave of COVID-19 cases during Fiscal 2022. In case the spread of COVID-19 increases dramatically like in the second wave and the concerned authorities put more stringent measures in place, it can have a debilitating impact on economic activity and thereby growth going forward. Availability of vaccines and the pace of vaccinations will be key monitorable; issues and any unavailability of vaccines is likely to hinder and delay economic recovery.

Geopolitical developments: External developments, most importantly the US-China trade war, have proved to significantly impact global GDP growth as well as export earnings and capital flows to emerging markets such as India. While there is some respite with the signing of Phase 1 of the US-China trade deal, several issues remain unresolved. Any re-escalation of tensions could again work adversely. Geopolitical developments in the Middle East could also disrupt crude oil supply and prices, likely hurting a wide range of domestic macroeconomic parameters, including current account deficit, inflation and GDP growth.

Persistent stress in financial sector: This has been one of the major drags on GDP growth in Fiscal 2021. Liquidity issues faced by NBFCs and risk aversion hampered credit growth as well as transmission of monetary policy easing. Easing of constraints in the financial system – a key monitorable – is critical for pick-up in growth.

GDP to recover over the medium term

CRISIL Research expects GDP to grow at approximately 11% in Fiscal 2022 and at an average of 6.2% between Fiscals 2023 and 2026, and expects India to emerge as one of fastest growing major economy across the globe. This growth will be supported by the following factors:

- CRISIL Research expects focus on investments rather than a consumption push to enhance the productive capacity of the economy. In Fiscal 2022 the government is set to focus on capital expenditure at a time when revenue realisation is likely to remain weak.
- Union Budget 2021-22 has also laid out a clear focus on mid-term growth trajectory. The government has set the

Fiscal glide path to 4.5% in Fiscal 2026 from 6.8% in Fiscal 2022. This underscores the government’s continued focus on expenditure over the medium term.

- Reforms undertaken over the past few years such as:
 - The production linked incentive (“**PLI**”) scheme which aims to incentivise local manufacturing by giving volume-linked incentives to manufacturers in specified sectors
 - Steep cut in corporate tax announced by the government in Fiscal 2020 is expected to attract more investments into the country and boost domestic manufacturing sector output over the medium to long term
 - Key structural reforms such as implementation of Goods and Services Tax (GST) and Insolvency and Bankruptcy Code (IBC) will begin to show its impact over the longer term
 - Reform measures aimed at enhancing financial inclusion like Pradhan Mantri Jan Dhan Yojana will broaden the base of the banking ecosystem, leading to higher lending and investment
 - Government initiatives like Digital India Initiative will aid digitalisation in the country. This will improve efficiency in the economy leading to faster growth.
- A raft of reform measures by the government along with a more expansionary stance of monetary policy leading to a steady pick-up in consumption demand.
- Policies aimed towards greater formalisation of the economy are bound to lead to an acceleration in per capita income growth.

India’s GDP will still grow faster than the world’s

India was one of the fastest-growing economies in the world with annual growth of around 6.7% in between 2014 to 2019. Over the past four fiscals, India’s macroeconomic situation has gradually improved: the twin deficits (current account and fiscal) have been narrowing and the growth-inflation mix has improved, and durably so. Both fiscal and monetary policies are more prudent, focusing on raising the quality and not just the rate of growth. The government has adopted an inflation-targeting framework that provides an institutional mechanism for inflation control, while modernising central banking. Fiscal policy has managed to stay mildly growth-focused, while managing a gradual reduction in the deficit. The upshot is that India’s macroeconomic variables are a lot more stable, and with sufficiently large reserves, the economy is more resilient against any global shock today, than it was during the Taper Tantrum of 2013.

Rapid urbanisation, rising consumer aspirations and increasing digitisation, coupled with government support in the form of reforms and policies, are expected to support long term growth. As per IMF’s forecasts, India is likely to emerge as the fastest growing country among major global economies over the 2021 and 2022 period.

India is one of the fastest-growing major economies (GDP growth, % on-year)

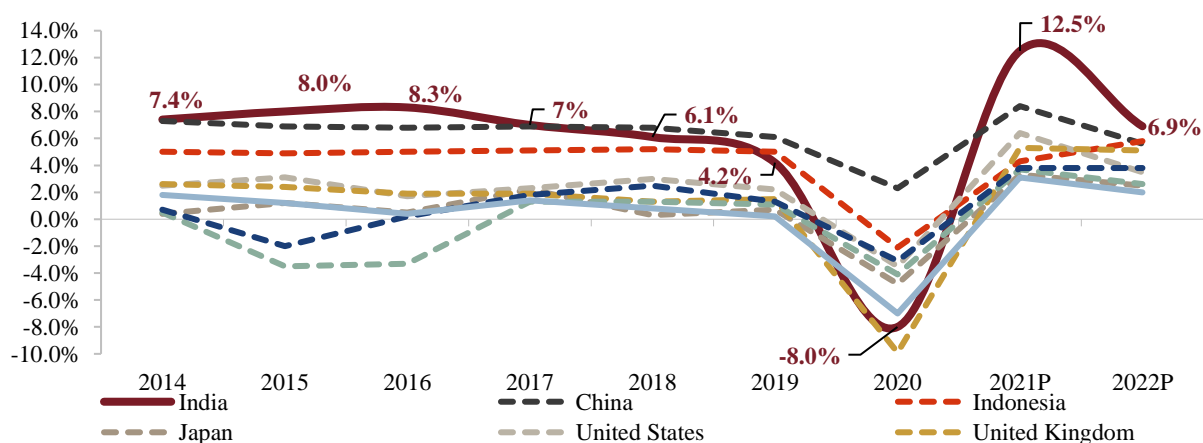

Note: GDP growth is based on constant prices, P: Projected; Years represents Calendar Year
Source: IMF (World Economic Outlook – January 2021 update), CRISIL Research

Key macroeconomic trends and long-term growth drivers

India has the world’s second largest population

As per Census 2011, India’s population was approximately 1.2 billion, and comprised approximately 246 million households. The population, which grew approximately 18% over 2001 and 2011, is expected to increase by 11%, approximately, over 2011 and 2021 to 1.4 billion. It is expected to reach 1.5 billion by 2031.

India's population growth trajectory

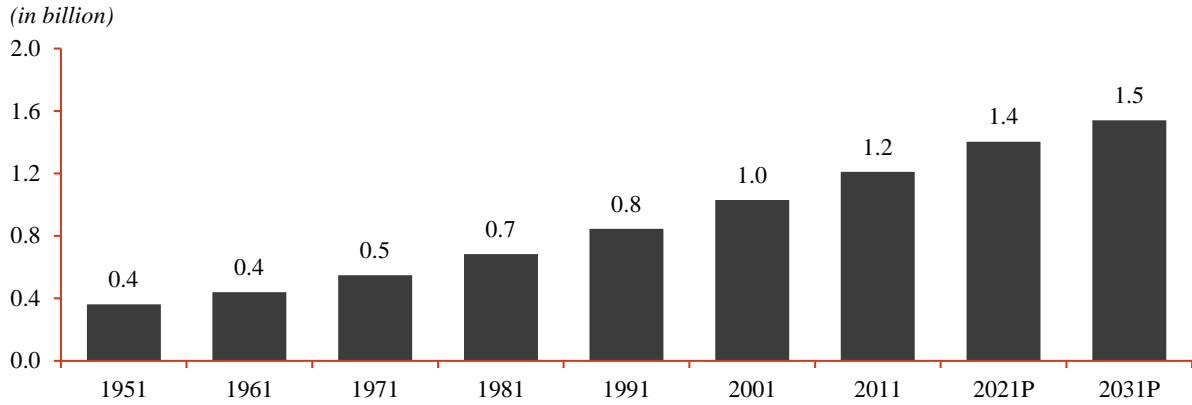

Note: P: Projected; Years represents Calendar Year

Source: United Nations Department of Economic and Social Affairs, CRISIL Research

Favourable demographics

As of 2020, India had one of the largest youth population in the world, with a median age of 28 years. About 90% of Indians would still be below the age of 60 years by end-2021, of which, CRISIL Research estimates, 63% would be between 15 and 59 years. In comparison, the U.S., China and Brazil had 74%, 62% and 78%, respectively, of their population below the age of 60. India is estimated to have approximately 27% of population aged between zero and 14 years, whereas the US, China and Brazil are estimated have approximately 18%, 18% and 21%, respectively, in the 0-14 year age group.

India's demographic dividend (population in billion)

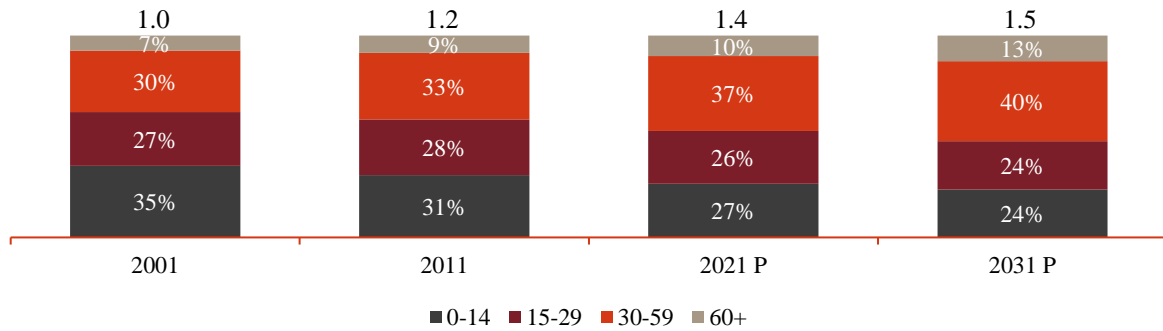

Note: E: Estimated; Years represents Calendar Year

Source: United Nations Department of Economic and Social Affairs, CRISIL Research

Urbanisation

Urbanisation is one of India's most important economic growth drivers, as it will drive substantial investments in infrastructure development, which, in turn, is expected to lead to job creation, development of modern consumer services and increased ability to mobilise savings. India's urban population has been rising consistently over decades. In 1950, it was 17% of the total population. As per the World Urbanization Prospects, the 2018 revision by the United Nations ("UN") estimates it was at approximately 34%. This is expected to reach approximately 37% by 2025.

Urban population (% of total population)

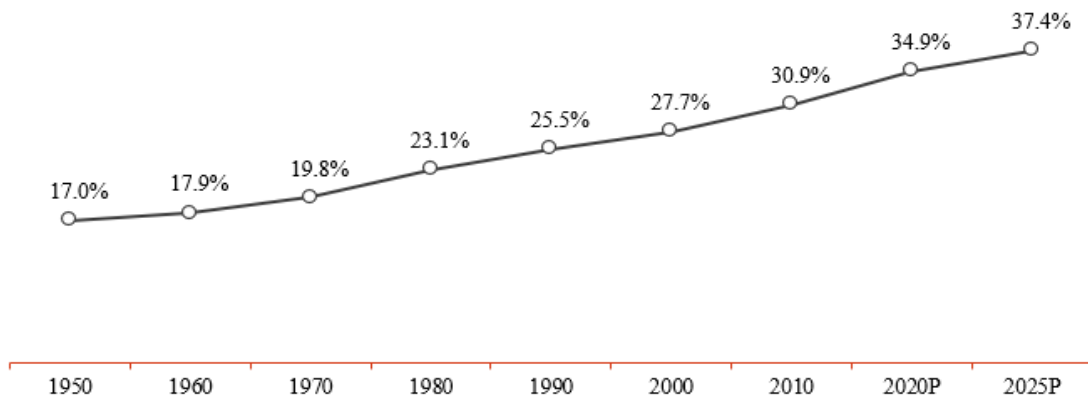

Note: Years represents Calendar Year

Source: Census 2011, World Urbanization Prospects: The 2018 Revision (UN)

Factors, such as urbanisation and favourable demographics, are likely to manifest in higher growth in per-capita income and increased propensity to spend on discretionary items, including automobiles, household appliances, mobiles and personal computers.

Increasing nuclearization

Increasing nuclearization of families is driving up consumption expenditure. In the recent past, the number of nuclear families, as a percentage of total household population, has increased. The average household size of the country has come down to 4.91 in 2011, from 5.57 in 1991.

Decline in size of households to drive overall growth in consumption

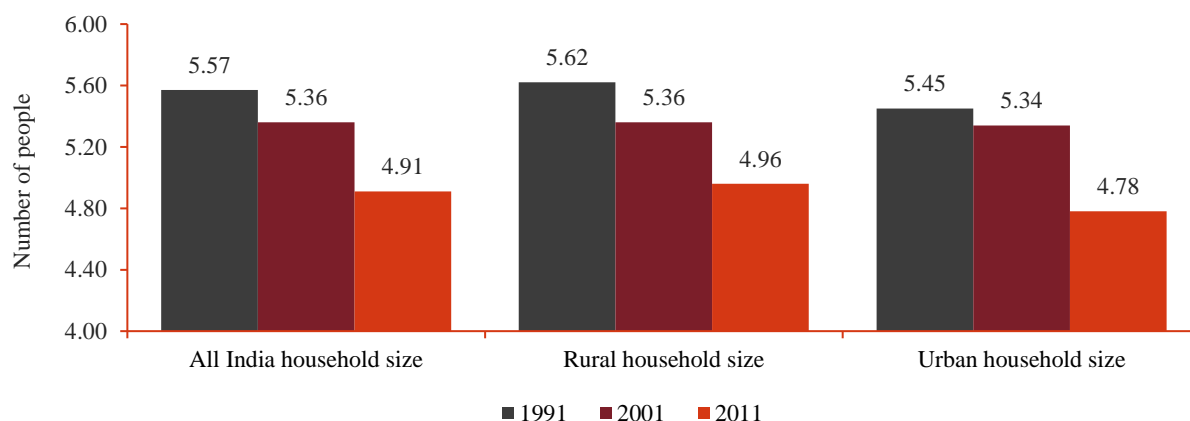

Note: Years represents Calendar Year
Source: Census 2011, CRISIL Research

Investments in smart cities will lead to better urban infrastructure

The government approved a budget of Rs. 480 billion for the development of 100 smart cities over five years, beginning in Fiscal 2017. The focus is on adequate and clean water supply, sanitation, solid waste management, efficient transportation, affordable housing for the poor, power supply, robust IT connectivity, e-governance, safety and security of citizens, health, and education.

Based on the overall plans for the first 90 cities, investments are expected to be construction-intensive, as segments such as housing, roads, non-residential development, and sewage systems will constitute a considerable portion of the total investments. The smart cities project is also expected to drive job creation in urban pockets, thereby accelerating urbanisation.

Increasing per-capital GDP

Per-capita income is estimated to have grown 3.1% in Fiscal 2020 to Rs. 152,000 per annum, compared to 5.8% growth in the preceding fiscal. However, it is forecasted to improve with GDP growth and sustained low inflation. This will be an enabler for domestic consumption. As per IMF estimates, India's per-capita income (at constant prices) is expected to grow at 6.7% CAGR between Fiscals 2020 and 2025.

Per capita income	Level in FY20 (INR- '000)^		Growth at constant prices (%)								
	Current prices	Constant prices	FY13	FY14	FY15	FY16	FY17	FY18	FY19	FY20 ^	FY25 E
	152	109	3.3	4.6	6.2	6.7	6.8	5.7	5.8	3.1	6.7*

Note: (*) – 5-year CAGR growth (FY20-FY25), as per IMF estimates of October 2020, (^) – provisional estimates by MoSPI, May 2020
Source: MoSPI, IMF, CRISIL Research

Key structural reforms: Long-term positives for the Indian economy

Production-linked incentive (PLI) scheme

The government has budgeted approximately Rs. 2 trillion as production-linked incentives to local manufacturing units in 13 key sectors. The key sectors likely to benefit from the scheme include automobiles, pharma, telecom, electronics, food, textiles, steel and energy. By incentivising production, subject to achieving the desired scale, the scheme aims to spawn a handful of globally competitive large-scale manufacturing units in the identified sectors. Furthermore, the government hopes to reduce India's dependence on raw material imports from China. The scheme is expected to provide a boost to economic growth over the medium term and create more employment opportunities, as many of these sectors are labour-intensive in nature.

Under the PLI scheme for the automotive sector, the government has planned four sub-schemes, viz., global sourcing scheme, vehicle champion scheme, component champion scheme, and production-linked Incentive scheme. Further, the government has laid out a stringent eligibility criteria in terms of minimum turnover, export revenue and investments in fixed assets, in order to ensure that implementation of the scheme offers desired results. Auto original equipment manufacturers (“OEMs”) need to showcase a minimum turnover of Rs. 100 billion, minimum exports of Rs. 10 billion and minimum investment in fixed asset of Rs. 35 billion in order to be eligible for this scheme. Auto component manufacturers need to showcase minimum turnover of Rs. 10 billion, minimum exports of Rs. 2 billion and minimum investment in fixed asset of Rs. 3.5 billion.

Financial inclusion

As per the Global Findex Database 2017, approximately 50% of the world’s unbanked adults are in India, Bangladesh, China, Indonesia, Mexico, Nigeria, and Pakistan. Of the world’s total unbanked adults (approximately 1.7 billion), 415 million are from just two countries – India (11% or 190 million) and China (13% or 225 million), because of their huge populations.

The government launched the Pradhan Mantri Jan Dhan Yojana (“PMJDY”) and Pradhan Mantri Jeevan Jyoti Bima Yojana (“PMJJBY”) schemes in 2014 and 2015, respectively, to promote financial inclusion. Under PMJDY, the government aims to ensure that every household in India has a bank account and affordable access to financial services such as savings and deposit accounts, remittance, credit, insurance, and pension. PMJJBY is a one-year life insurance scheme that offers a life cover of Rs. 0.2 million at a premium of Rs. 330 per annum per member, which can be renewed every year. The government has also launched the Pradhan Mantri Suraksha Bima Yojana (“PMSBY”) scheme – an accident insurance policy that offers an accidental death and full disability cover of Rs. 0.2 million at a premium of Rs. 12 annually. According to the government, more than 100 million people have registered for these social security schemes.

PMJDY focuses on household coverage unlike the earlier schemes that focused on coverage of villages. It aims at extending banking facilities to all within a reasonable distance in each sub-service area (consisting of 1,000-1,500 households) across India. As on December 16, 2020, 415 million PMJDY accounts had been opened, of which 65% were in rural and semi-urban areas, with total deposits of Rs. 1,317 billion.

GST implementation

Introduced on July 1, 2017, GST is an indirect tax regime that has subsumed multiple cascading taxes levied by the central and state governments. Its implementation has spawned structural changes in the supply chain and logistics network in the country. The crux of the GST mechanism is input-tax credit, which ensures that more players in the supply chain come under the tax ambit. As supply from only registered taxpayers will get input-tax credit, businesses and stakeholders will insist on registration of their suppliers and traders, leading to an increase in the share of organised participants. The GST regime has been stabilising fast and is expected to bring more transparency and increase formalisation, eventually leading to higher economic growth.

GST collection (Rs. trillion)

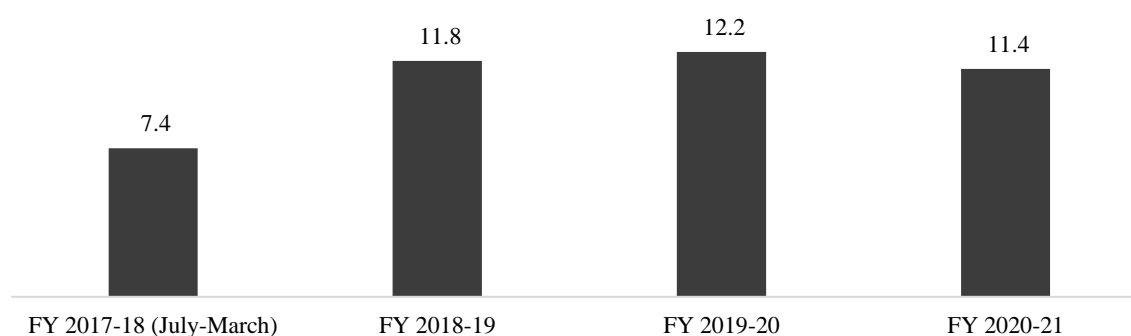

Source: Goods and Services Tax Network

GST collection grew 3.8% in Fiscal 2020 over Fiscal 2019. It hit the Rs. 1 trillion mark for the first time in April 2018 and averaged Rs. 1.01 trillion in Fiscal 2020. GST collection slumped as the country went into a complete lockdown in the latter half of March 2020. It has seen a sharp recovery in recent months; monthly GST collection touched Rs. 1.23 trillion in March 2021 – the highest since its implementation.

Thrust on affordable housing

The residential real estate segment saw two policy changes – the Real Estate (Regulation and Development) Act and GST – which had a direct impact on the sector's demand-supply dynamics. Consequently, new launches dropped sharply, with developers focussing on completing ongoing projects. The sector had been battling weak demand over the past couple of years. As developers focussed on middle-income and premium segments, several projects turned unaffordable for most consumers. However, government initiatives have prompted developers to explore affordable housing as a new area. Going ahead, about half of the incremental supply to be added to the urban stock is expected to be via affordable housing. Additionally, formalisation of the industry is likely to bring in more transparency, leading to an increase in consumer demand.

Insolvency Bankruptcy Code (IBC)

IBC is a reform that will structurally strengthen the identification and resolution of insolvency in India. It enhances the credit enforcement structure and offers certainty on the time frame for insolvency resolution. The code attempts to simplify legal processes, preserve value for creditors, and provide them with a greater certainty of outcome. With this reform, the RBI has sent a strong signal to borrowers to adhere to credit discipline and encouraged banks to break resolution deadlocks by introducing definite timelines. IBC will boost investor confidence in the Indian financial market. Internationally, the recovery rate has improved significantly after the implementation of bankruptcy reforms, as evident from the table below:

Country	Year of bankruptcy reform	Before reforms		Five years after reforms	
		Recovery rate (%)	Time (years)	Recovery rate (%)	Time (years)
Brazil	2005	0.2	10.0	17.0	4.0
Russia	2009	28.2	3.8	42.8	2.0
China	2007	31.5	2.4	36.1	1.7
India	2016	26.0	4.3	43*	1.6*

*As of 2019

Source: World Bank, CRISIL Research

The enactment of IBC has shifted the balance of power from the debtor to the creditor. As many as 3,911 corporate insolvency resolution processes commenced between December 1, 2016 and June 30, 2020. Among these, 380 were closed on appeal or review or settled, 218 were withdrawn, 955 ended in orders for liquidation, and 250 ended in approval of resolution plans. Until 2015, it usually took 4.3 years on average to resolve an insolvency case in India. This reduced to 1.6 years in 2019 after IBC came into effect, and the period is expected to fall further.

Reduction in corporate tax rates

On September 20, 2019, the finance minister announced the Taxation Laws (Amendment) Ordinance, 2019 to make certain amendments in the Income Tax Act, 1961, to provide all domestic companies an option to pay income tax at the rate of 22%, provided that they will not avail of any exemption/incentive. The effective tax rate for these companies will be 25.17%, inclusive of surcharge and cess (as compared to 34.32% earlier). Also, such companies will not be required to pay minimum alternate tax (“MAT”).

The recent amendments have the potential to boost the capital base of financial institutions and revive growth in the financial services sector, which has been weighed down by high non-performing assets, increasing defaults, and liquidity concerns. They could also revive the private capex cycle, leading to credit growth in the economy.

REVIEW AND OUTLOOK OF INDIAN TWO-WHEELER INDUSTRY

(The following has been sourced from pages 25 to 43 of the CRISIL Report).

Indian two-wheeler industry review (Fiscals 2016 – 2021)

Production volume

India is among the top two producers of two-wheelers globally. The two wheelers segment also dominates the Indian automobile industry accounting for approximately 80% of industry output in volume terms. Domestic two-wheeler production remained flat between Fiscals 2016 and 2021. During Fiscals 2016 to 2019, the industry’s production increased at a CAGR of 9.3%, propelled by good monsoons, the favourable economic situation, and rising exports. In Fiscal 2020 there was 14.1% decrease in production volume from Fiscal 2019, owing to transition to Bharat Stage (BS)-VI norms, and in Fiscal 2021 there was a 12.6% decrease in production due to challenges heaped by the COVID-19 pandemic.

Two-wheeler production volume

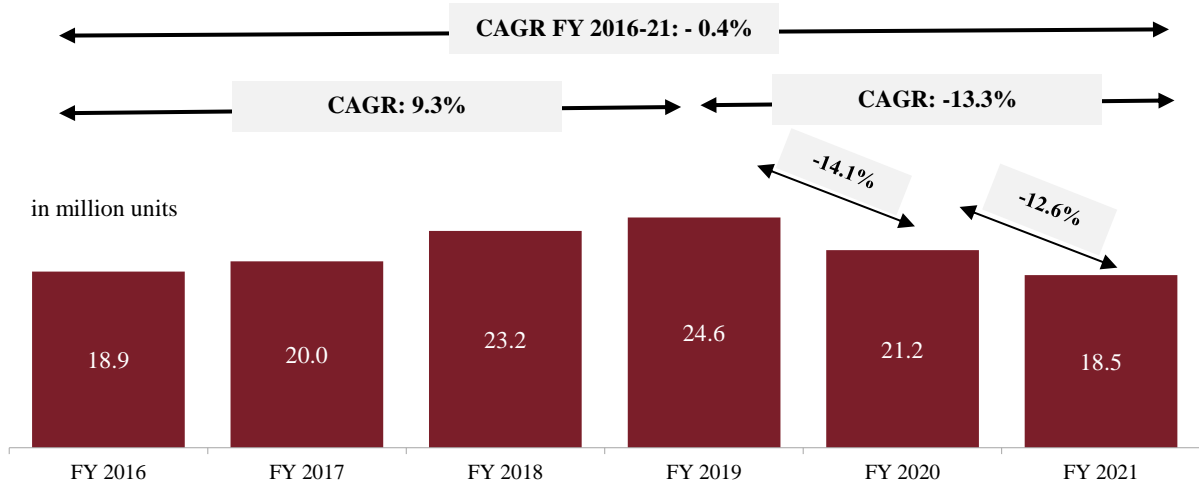

Source: Society of Indian Automobile Manufacturers (SIAM), Society of Manufacturers of Electric Vehicles (SMEV), CRISIL Research

Domestic sales vis-à-vis exports

The Indian two-wheeler industry is primarily domestic-skewed, with domestic sales accounting for approximately 86% share of overall two-wheeler sales in the past five years. However, over the years, manufacturers, such as Bajaj Auto, TVS Motor Company and HMTI, have been expanding their geographical footprint. Also, joint ventures with global brands, such as KTM, BMW and Husqvarna, and catering to the global demand of these brands from India, have given an additional thrust to two-wheeler exports.

Two-wheeler domestic sales and exports volume break up

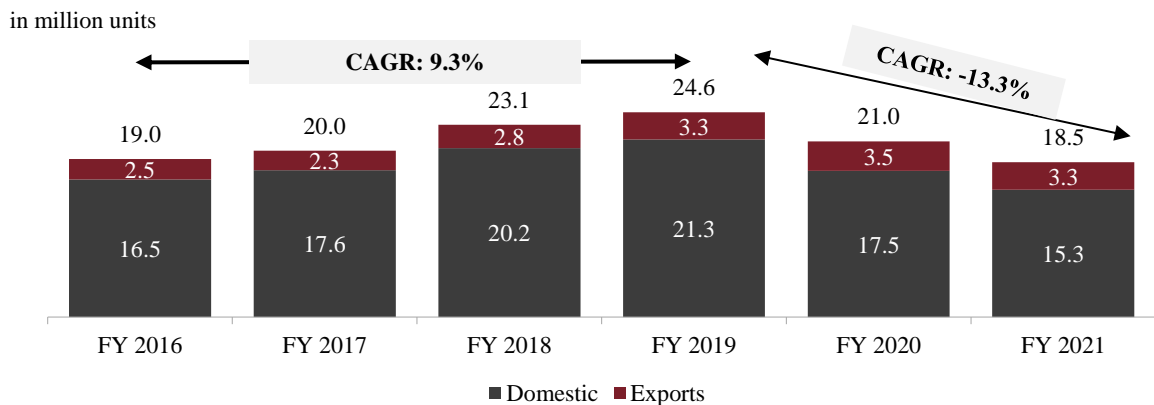

Source: SIAM, SMEV, CRISIL Research

Indian two-wheelers are primarily exported to crude oil exporting developing countries, primarily in Africa and Latin America, and contributed approximately 65% of India's exports in Fiscal 2020.

Domestic and export-wise motorcycle, scooter and moped sales

Motorcycles dominated the domestic two-wheeler space, with approximately 66% market share in Fiscal 2021. Over 2016 to 2020, though, the share of scooters had risen from 31% to 33%. The expanding share was because of strong demand, following new model launches (including variants with higher engine power), aggressive marketing strategies, such as gender-based positioning, increasing usage of scooters by working women in urban areas (due to convenience), and growing preference for scooters as a second vehicle by households. However, in Fiscal 2021, because of urban regions facing stricter lockdown, sales of scooters declined.

Segment-wise domestic two-wheeler volume share

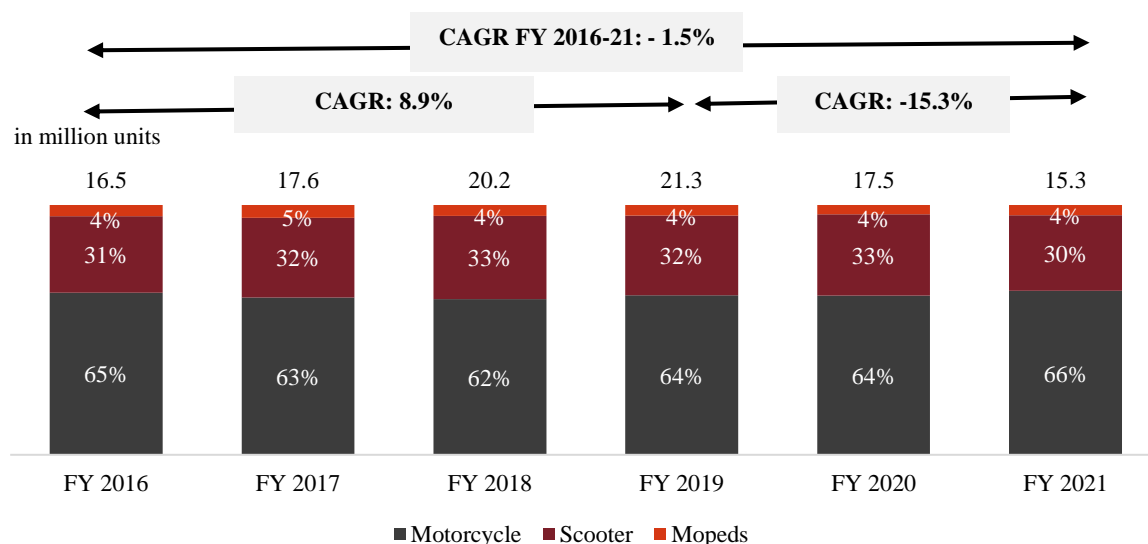

Source: SIAM, SMEV, CRISIL Research

Segment-wise break up of domestic motorcycle

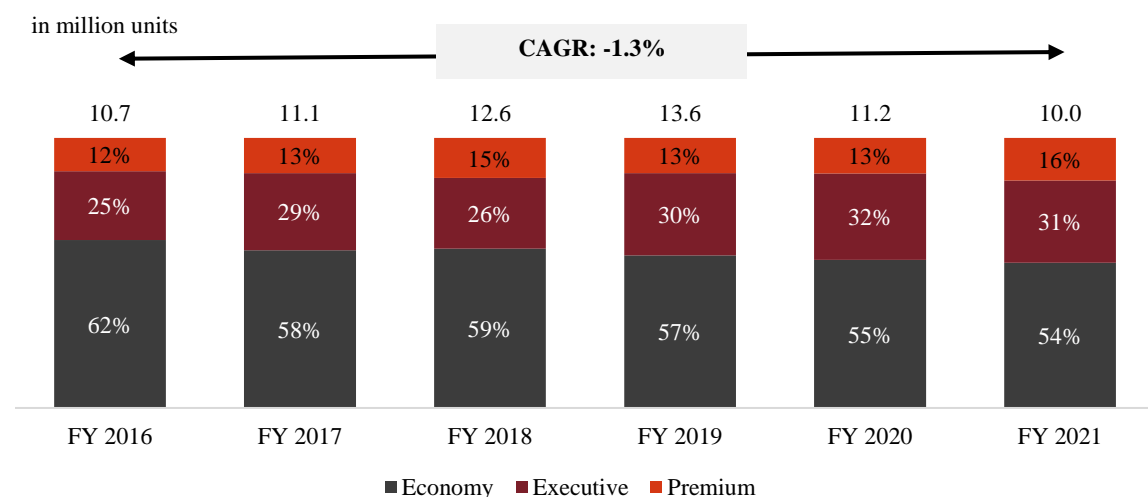

Note: Economy – Engine capacity < 110cc; Executive – Engine capacity – 110-150cc; Premium – Engine capacity > 150cc
 Source: SIAM, SMEV, CRISIL Research

Share of premium motorcycles in overall motorcycles have risen to 16% in Fiscal 2021 from 12% in Fiscal 2016 driven by rising affordability, entry of premium bike manufacturers in India, launch of new products in premium motorcycle segment and growing customer preference to premium and better performance motorcycles. Despite a 1.3% CAGR decline in demand for motorcycles, demand for premium motorcycles grew at 3.6% CAGR over Fiscal 2016 to 2021.

In exports as well, motorcycles have the dominant share. These are largely exported to African and Latin American countries. Exports of premium motorcycles are also gaining traction, mainly to developed regions, such as the EU. Scooters are mainly exported to Asian countries.

Two-wheeler export sales segmental volume share

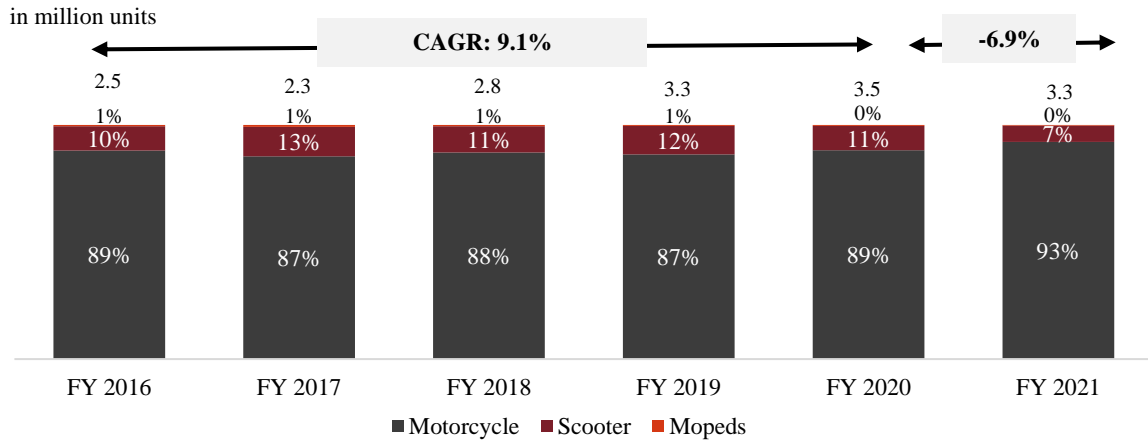

Source: SIAM, SMEV, CRISIL Research

Key domestic regulations

The Indian government has been taking aggressive steps to converge emission standards with global norms. In February 2016, it decided to skip BS-V norms and directly mandate BS-VI norms. Compliance with the latest emission standards requires improvement mainly in the exhaust system, thereby increasing the prices of the two-wheeler.

Regulatory timeline and its impact on prices

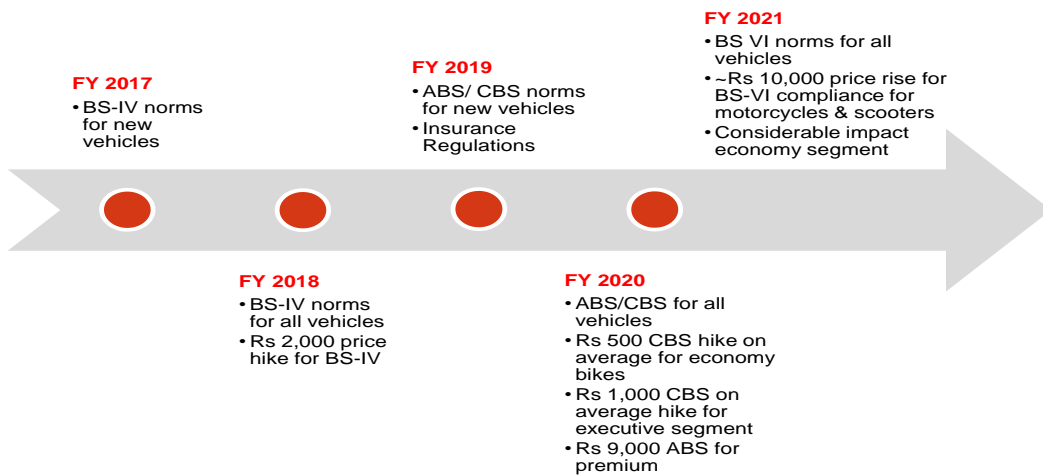

Source: Industry, CRISIL Research

Finance availability

Finance penetration is lower in two-wheeler segment compared with other automotive segments, given the industry's smaller ticket sizes, relatively lower income profile of customers, high default rates, and difficulty in repossessing vehicles.

Two-wheeler finance penetration, FY16-FY21E

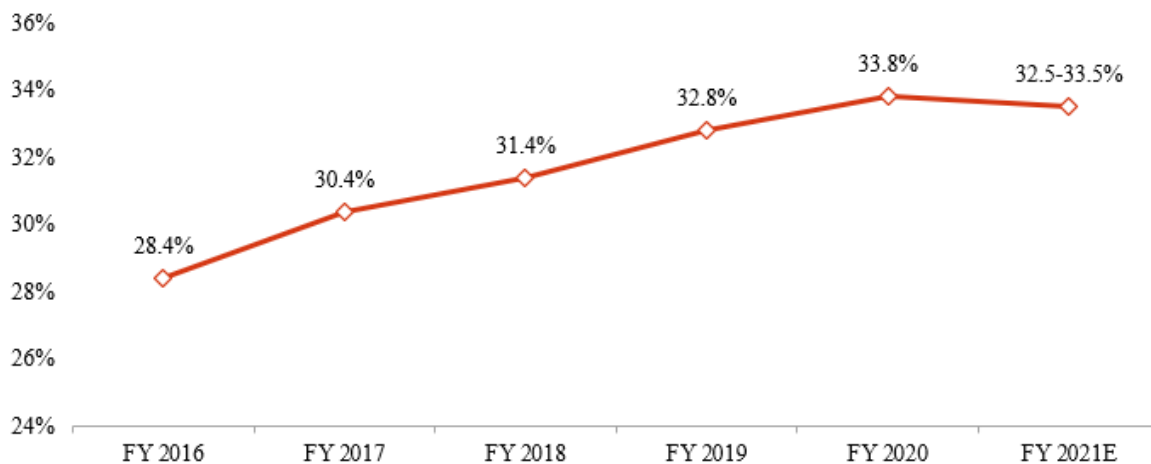

Note: E – Estimated, Finance penetration indicates number of vehicles financed per 100 two wheelers sold in India

Electric vehicle penetration

India is a signatory to the Paris Agreement under the United Nations Framework Convention on Climate Change. The country is also part of the EV30@30 campaign, targeting a 30% sales share for EVs by 2030.

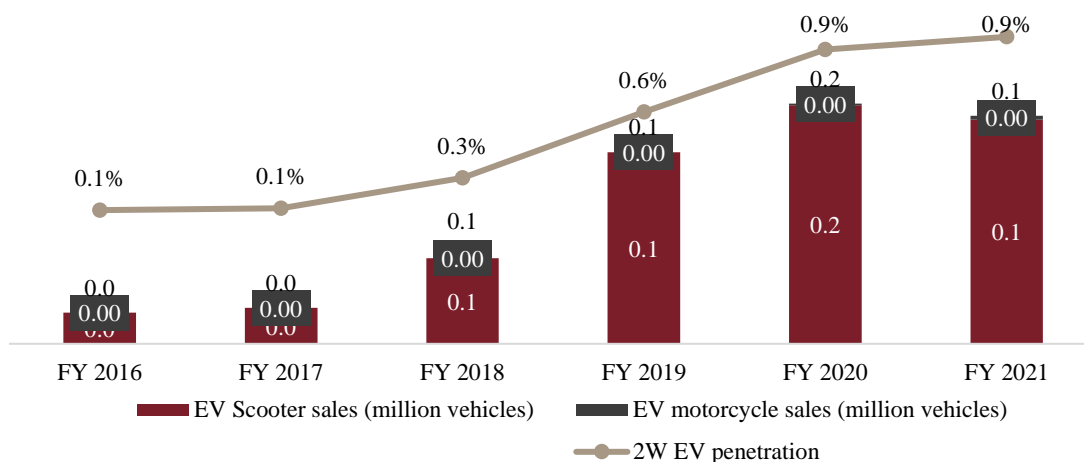

Note: EV penetration is calculated as number of electric two wheelers sold as a proportion total two wheelers (inclusive of ICE and EV) sold in India
 Source: SIAM, SMEV, CRISIL Research

However, due to the high cost of lithium-ion batteries, along with inadequate charging infrastructure, the penetration of electric two-wheelers (e-2Ws) is still below 1% and comprises mainly low speed electric scooters.

Penetration of electric motorcycles is also currently low on account of lack of availability of established electric model in affordable or premium segment. Factors, such as higher cost of ownership, unavailability of easy finance, lack of proper charging infrastructure in urban as well as rural areas, etc., are key constraints for adoption of electric motorcycles in affordable motorcycle segment. On the contrary, even a premium motorcycle user is hesitant to shift to electric motorcycle due to user preference for internal combustion engine (“ICE”) motorcycles because of driving feel-related factors, lack of availability of high performance electric motorcycles at comparable price points to ICE, insufficient range profile of existing products and lack of charging infrastructure outside city limits.

Outlook on Indian two-wheeler industry (Fiscals 2021 – 2026P)

Production volume outlook

Overall domestic two-wheeler production is expected to grow at a robust pace of 10.9% CAGR over Fiscals 2021-26 to reach approximately 31.0 million units by Fiscal 2026. Domestic sales and exports are estimated to grow at 11.2% and 9.5% CAGR, respectively, during this period. However, the risk of subsequent waves of COVID-19 cases and the need for the state and central governments to impose localised or extensive lockdown to control spread of pandemic may have an impact on supply chains as well as sales volumes. In such a case, overall industry production is also likely to be impacted over the short term.

Two-wheeler production volume outlook

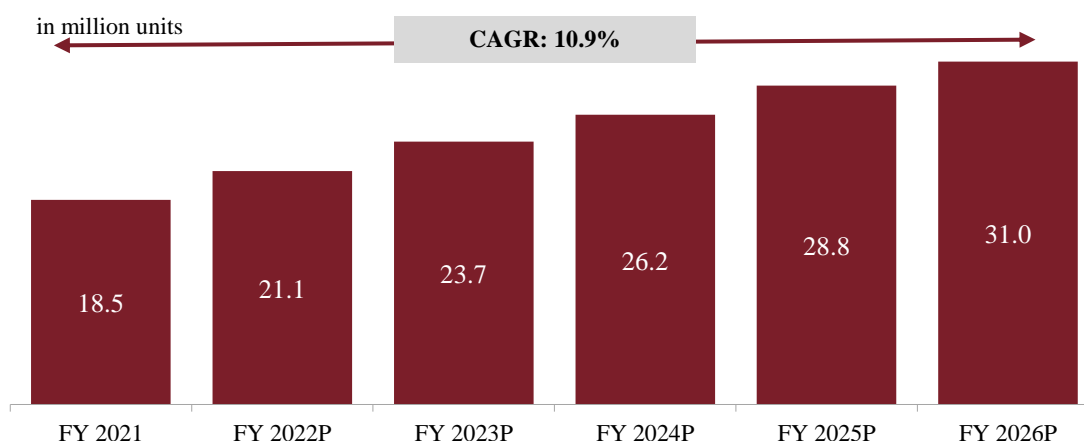

Source: SIAM, SMEV, CRISIL Research

Split by domestic sales and exports

Domestic sales volume (80-85% of total production) is estimated to grow at a 11.2% CAGR over the five-year period, after declining 18% on-year in Fiscal 2020 and 13% in Fiscal 2021. Higher GDP growth and lower inflation would boost domestic sales volume, led by better affordability with a rise in disposable incomes. Rising income will be further aided by better rural connectivity and rising women workforce in urban and rural areas. The under-penetrated rural market is likely to be the key growth segment for the two-wheeler industry. Preference to personal mobility on account COVID-19 pandemic will also support demand over the short to medium term till a time reliable solution to COVID-19 pandemic becomes widely available.

Two-wheeler domestic and exports outlook

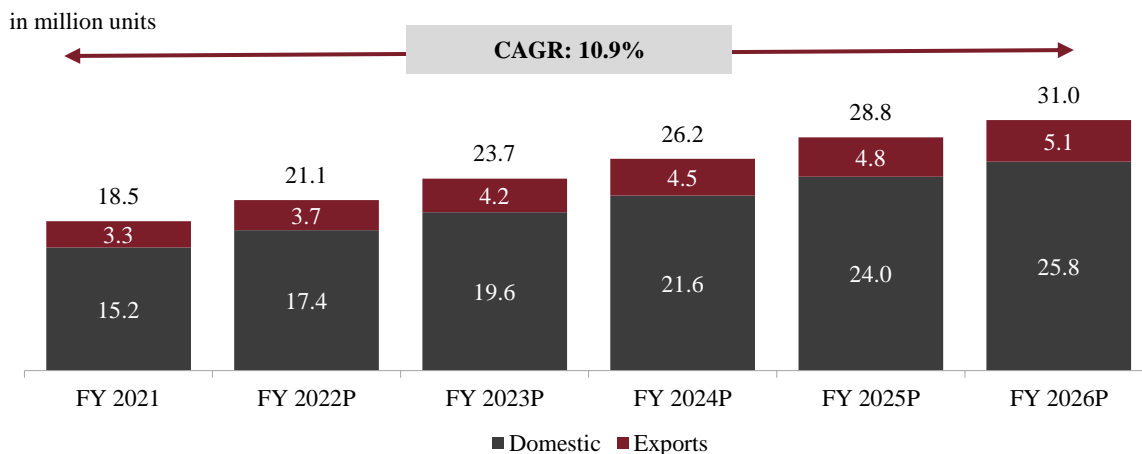

Source: SIAM, SMEV, CRISIL Research

CRISIL Research expects two-wheeler exports from India to grow at a CAGR of 9.5% over Fiscals 2021- 2026 compared with 5% between Fiscals 2016-2021. While expanding geographical footprints and extensive product portfolios would drive growth, crude oil prices and currency fluctuations in export markets will remain key monitorables. Moreover, government initiatives to make India an exports hub, along with policies, such as production-linked incentive (PLI), provide further impetus to two-wheeler exports. Even in case of export, OEM sales are likely to come under pressure in case of a worsening of the COVID-19 situation in key export markets.

Split by motorcycles, scooters and mopeds

CRISIL Research expect scooters to grow at the fastest pace of 15.8% over Fiscals 2021-2026, followed by motorcycles at 9.0%, and mopeds at 5.9%.

Two-wheeler domestic sales outlook segment-wise share

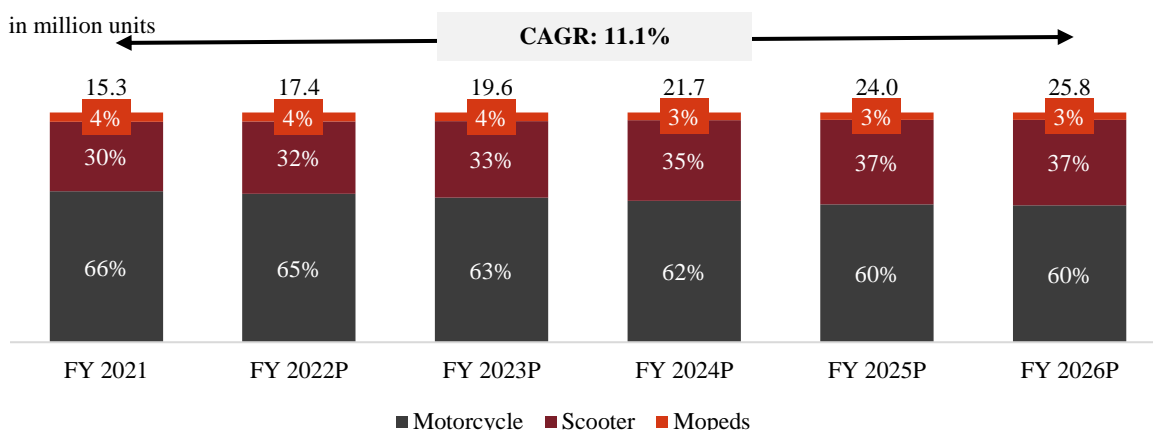

Source: SIAM, SMEV, CRISIL Research

Improving rural productivity, diversification towards horticultural crops, government income support schemes and structural reforms, such as PM-KISAN, eNAM, Pradhan Mantri Fasal Bima Yojna, will aid rural income in the long run. Here, the motorcycle segment stands to be a primary beneficiary.

Scooters are expected to witness higher penetration in the under-penetrated rural market (already having an urban market share of approximately 65-70%) driven by participation of women in the workforce, being preferred as a family commute option, and

by its suitability for carrying loads in e-commerce applications.

Segment-wise breakup of domestic motorcycle

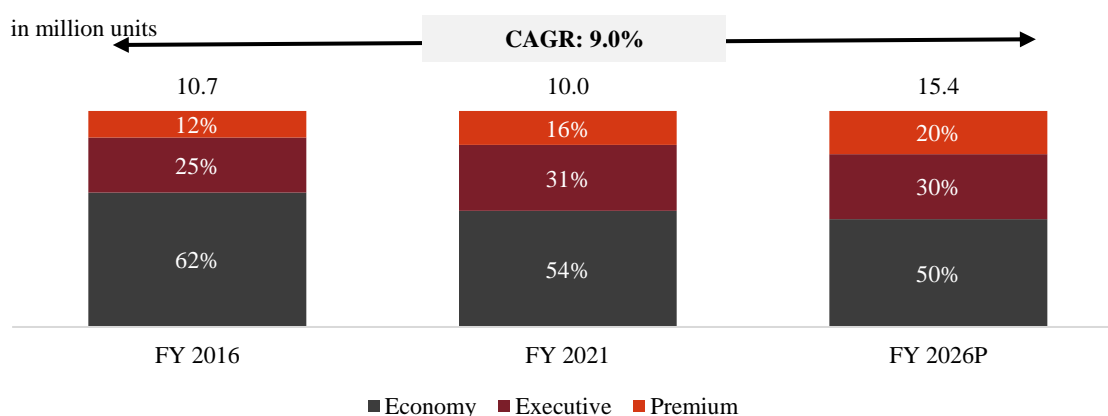

Note: Economy - Engine capacity < 110 cc; Executive – Engine capacity - 110-150 cc; Premium - Engine capacity > 150 cc Source: SIAM, SMEV, CRISIL Research

Growing preference for premium motorcycles is likely to continue even in future supported by rising affordability. Accordingly, the share of premium motorcycles is expected to further rise to 20% by Fiscal 2026 from 16% in Fiscal 2021. Demand for premium motorcycles is expected to grow at approximately 14% CAGR over Fiscal 2021 to 2026 period compared to overall approximately 9% CAGR growth in demand for motorcycles.

Government intervention in regulations and policies

The Government of India, through various ministries, has formulated policies for the development of the EV sector in India. The following table lists some of the policies and their expected outcomes:

Policy	Policy details	Expected outcome
Reduction in the GST rate for EVs and chargers	-From 12% to 5% for EVs, and 18% to 5% for chargers, effective from August 1, 2019	-EV acquisition cost came down. Fast-charging infrastructure cost also reduced
Union Budget 2019-20	-Income tax deduction of Rs 1.5 lakh on EV loans	-TCO decreased, especially for salaried professionals
Warranty condition for eligibility of vehicle under FAME II (May 15, 2019)	-Warranty condition revised to 3 years subject to 20,000 km; earlier warranty on vehicles was provided for one year only	-Customer perception of low quality of EVs will change
FAME II subsidy (March 22, 2019) valid till FY22	-1 million e2W to be given subsidy at Rs. 10,000 / kwh or 20% of ex-factory price (limited to Rs 1.5 lakh)	- e2W acquisition cost came down, with subsidy ranging up to 20% of ex-factory price for current models
State EV policies	-8 states have finalised their EV policies and 8 others have draft policies -Policy entails supply and demand-side incentives	-Maharashtra and Delhi are offering incentives, further decreasing acquisition cost -Demand-side incentives include reduced tariff for EV charging, rebates on road tax, interest-free loans for auto component manufacturer, and cost split for skill development

Source: SMEV, FAME, DHI, and CRISIL Research

FAME-II

Launched in April 2019, the FAME-II policy was issued to drive ETW sales and curb pollution, targeting sales of one million high-speed ETWs by the end of Fiscal 2022. Under the scheme, only advanced batteries and registered vehicles are incentivised, with a greater emphasis on providing affordable and environment-friendly public transportation options. Therefore, the scheme is mainly applicable to vehicles used for public transport or those registered for commercial purposes in the e-3W, e-4W and e-bus segments. However, privately owned registered e-2Ws are also covered under the scheme as a mass segment.

The scheme excludes lead-acid battery-powered two-wheelers. Additionally, as per the eligibility criteria, e-scooters ought to

have a minimum range of 80 km per charge and a minimum top speed of 40 kmph, along with riders on energy consumption efficiency, minimum acceleration and a higher number of charging cycles. This precludes more than 90% of the remaining lithium-ion battery-driven models from the subsidy.

Regulators are expected to play an important role in driving faster adoption of EVs. The FAME II scheme has an outlay of Rs. 100 billion, with a major proportion dedicated to demand incentives; Rs. 10 billion is earmarked for the development of charging infrastructure. Demand-side incentives under the FAME II scheme will last until Fiscal 2022, and state EV policies (mostly of five-year tenure) will last until Fiscal 2023. Continuation of policies after Fiscal 2023 will play an important role in driving adoption of hybrid and EVs. Execution of the schemes will also be a key factor considering that only Rs. 4.4 billion of the Rs. 8.93 billion allocated to FAME I has been utilised.

Estimated penetration of electric two-wheelers by Fiscal 2026

Two-wheeler EV penetration outlook, Fiscals 2021-2026P

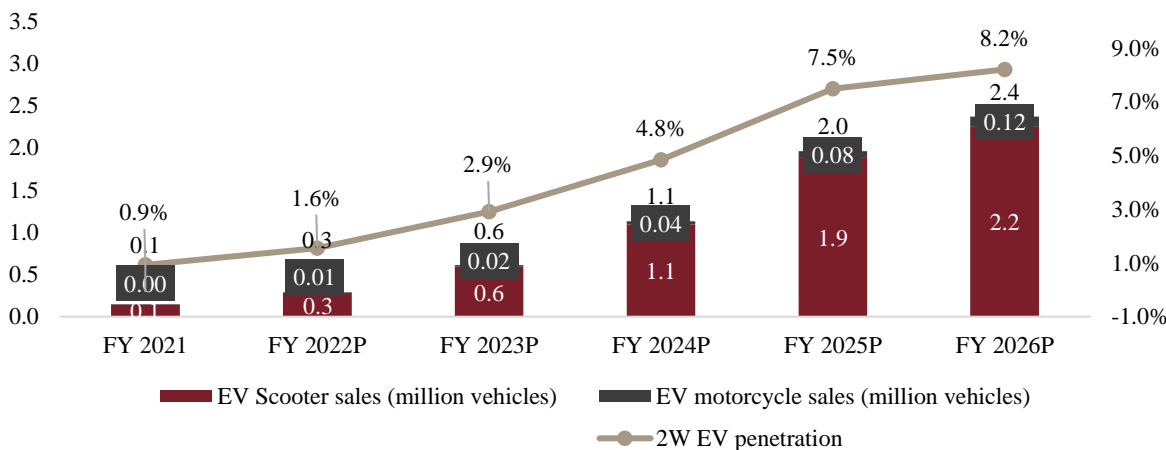

Note: EV penetration is calculated as number of electric two wheelers sold as a proportion total two wheelers (inclusive of ICE and EV) sold in India.
Source: SIAM, SMEV, CRISIL Research

CRISIL Research estimates e-2W penetration to reach approximately 8% by Fiscal 2026 from approximately 1% currently.

A bulk of migration towards EVs is expected from the scooter segment. Notably, scooters have a higher urban penetration of around 65-70% compared to motorcycles that are largely rural demand driven.

EV penetration in scooters is expected to reach approximately 25-27% by Fiscal 2026, whereas EV penetration in motorcycles is expected to stay below 1%.

Scooter EV penetration outlook, Fiscals 2021-2026P

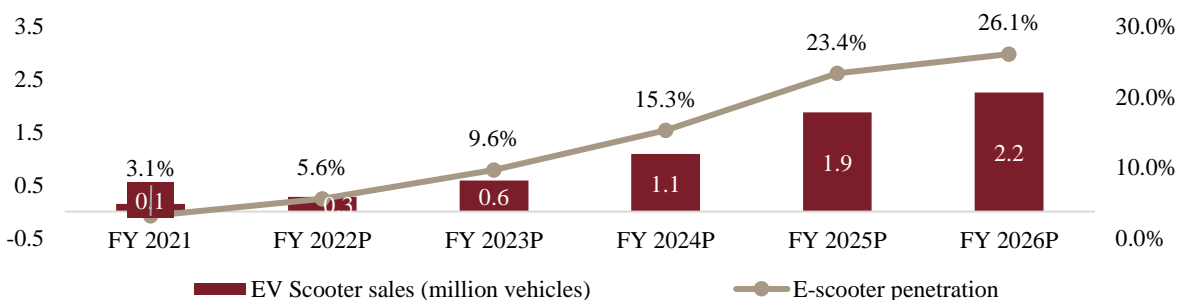

EV penetration in motorcycles is unlikely to pick up despite improvement in charging infrastructure on account of lack of affordability of electric motorcycles and limited availability of electric motorcycle options in affordable and premium segment. Factors such as higher total cost of ownership compared to ICE motorcycles even at reduced battery prices, lack of proper charging infrastructure in rural areas, etc. will remain key constraints for adoption of electric motorcycles in the affordable motorcycle segment. Even in the premium motorcycle segment, user preference for ICE over electric vehicles due to driving feel related factors is likely to limit electrification in the premium motorcycle segment.

Motorcycle EV penetration outlook Fiscals 2021-2026P

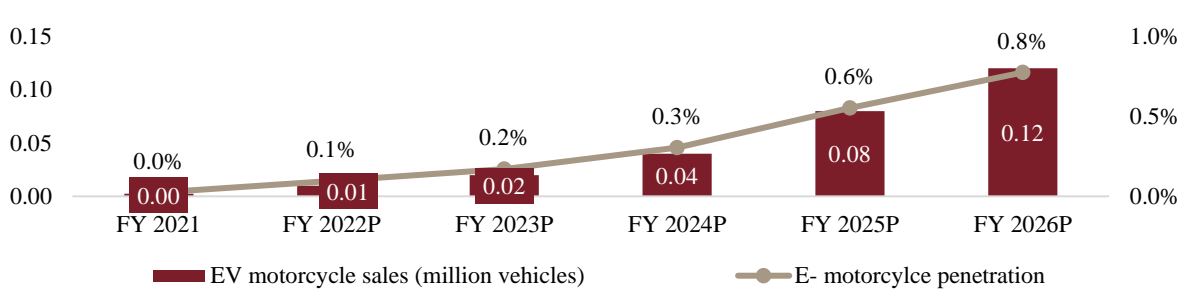

Note: EV penetration is calculated as number of electric two wheelers sold as a proportion total two wheelers (inclusive of ICE and EV) sold in India
 Source: SIAM, SMEV, CRISIL Research

REVIEW AND OUTLOOK OF THE GLOBAL LIGHT VEHICLE INDUSTRY

(The following has been sourced from pages 5 to 9 of the Ricardo Report).

Global Light Vehicle Production

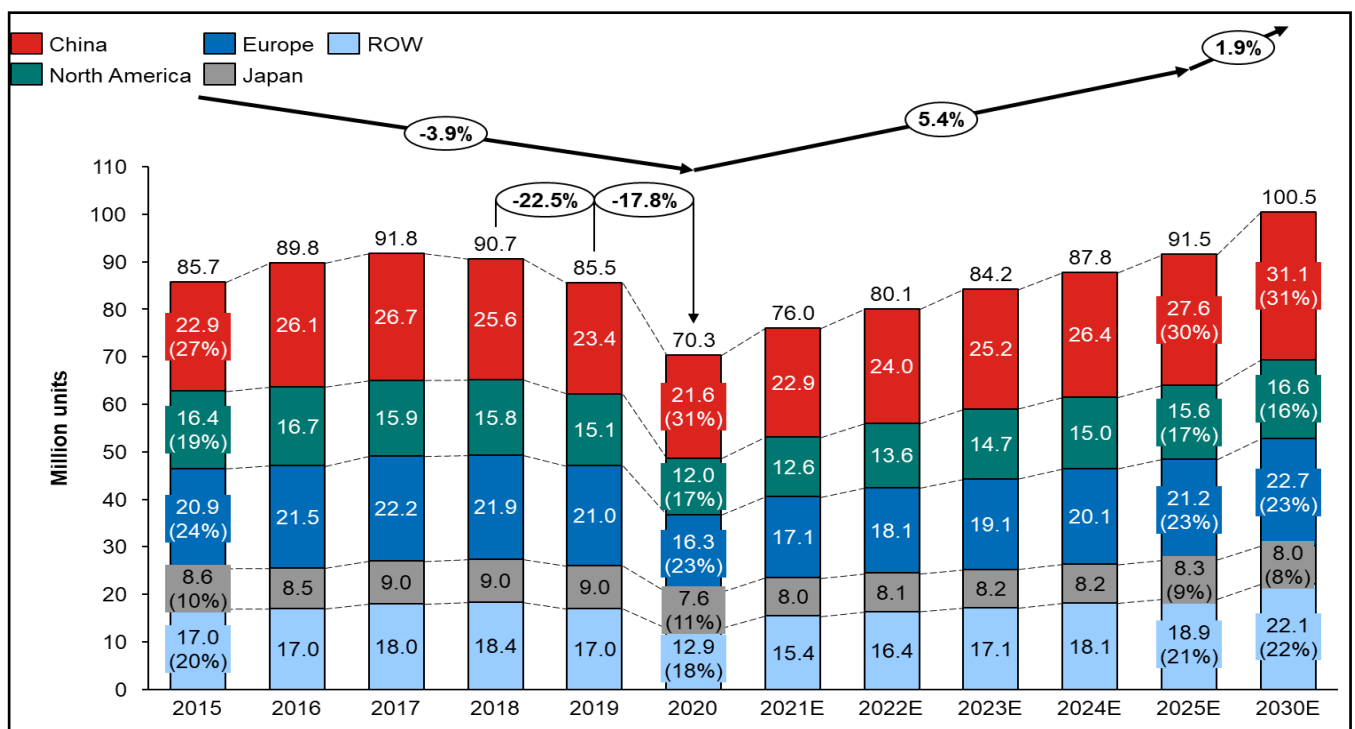

Source: OICA – International Organisation of Motor Vehicle Manufacturers, Ricardo Analysis

Global Light Vehicle (Passenger Vehicles GVW <= 3.5T) production has remained flat between 2015-2019. However, vehicle production declined by approximately 17.8% in CY 2020 from CY 2019 due to COVID-19. Global Light Vehicle production declined by 22.5% in CY 2019 from CY 2018.

Given that the USA and most parts of Europe are still severely impacted by COVID-19, Ricardo does not expect a V-shaped recovery for the passenger vehicle market, but a more gradual recovery coming out of the pandemic. Production in CY 2021 is projected to grow by approximately 8.1% YoY, primarily driven by the Chinese market. Despite realising growth in Q1 2021, the pandemic and the chip shortage issues continue to be the biggest concerns.

Ricardo expects overall global volumes to reach approximately 91.5 million by CY 2025 and approximately 100.5 million by CY 2030 with China, Europe and North America accounting for approximately 70% of the global production volume. Ricardo expects the share in global production volume of the rest of the world (i.e., South America, South Asia and the Middle East) to grow from approximately 18.3% in 2020 to approximately 21.9% in 2030 largely driven by developing regions/ countries such as India and ASEAN countries (e.g., Malaysia, Vietnam and Indonesia).

Global Light Vehicle OEM Market Share – 2020

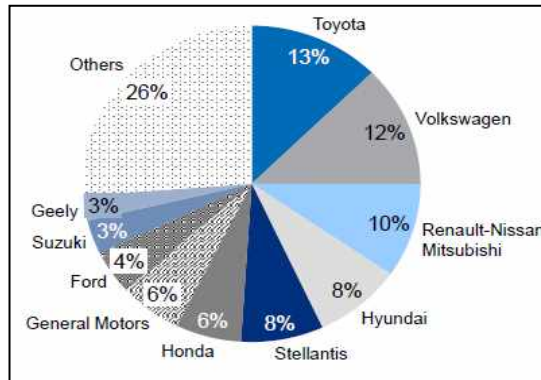

Source: Ricardo Analysis, Public Domain

Top 10 OEMs in the Light Vehicle segment accounted for approximately 74% of the total production in CY 2020. Toyota leads the light vehicle market with approximately 13% share followed closely by Volkswagen with approximately 12% and Renault Nissan Mitsubishi alliance with approximately 10%. Over the years, Toyota and Volkswagen have been battling to be the number one OEM in passenger vehicle production. Post-merger of FCA and PSA, Stellantis N.V. (formerly Fiat Chrysler Automobiles) is now among the top five global OEMs in terms of production volumes displacing Honda and General Motors. Geely, with a share of 3%, is the only Chinese brand with significant share.

Propulsion Split

Fuel Economy Norms in Key Markets:

Fuel economy and CO₂ norms are being implemented globally to counter climate change. Financial penalties might be levied if standards are not met. As in the case of complying with stringent emission norms, manufacturers require significant investments on development of ICE technology to meet fuel economy targets while electrified vehicles continue to proliferate.

- Currently, China's CAFC/CO₂ regulations are in phase 4, which requires manufacturers to meet a fleet average of 5.0 L/100km for new vehicles and phase 5, which was published at the end of 2019 targets 4.6 L/100 km by 2025.
- Europe had established a CO₂ fleet average targets of 130 g/km in 2012 for passenger vehicle segment and it has become stringent in 2020 with a target of 95 gm/km; they are expected to become more severe from 2025 with a goal of 15% reduction from 2021 levels.

Passenger Car Fuel Economy, Normalised to CAFÉ

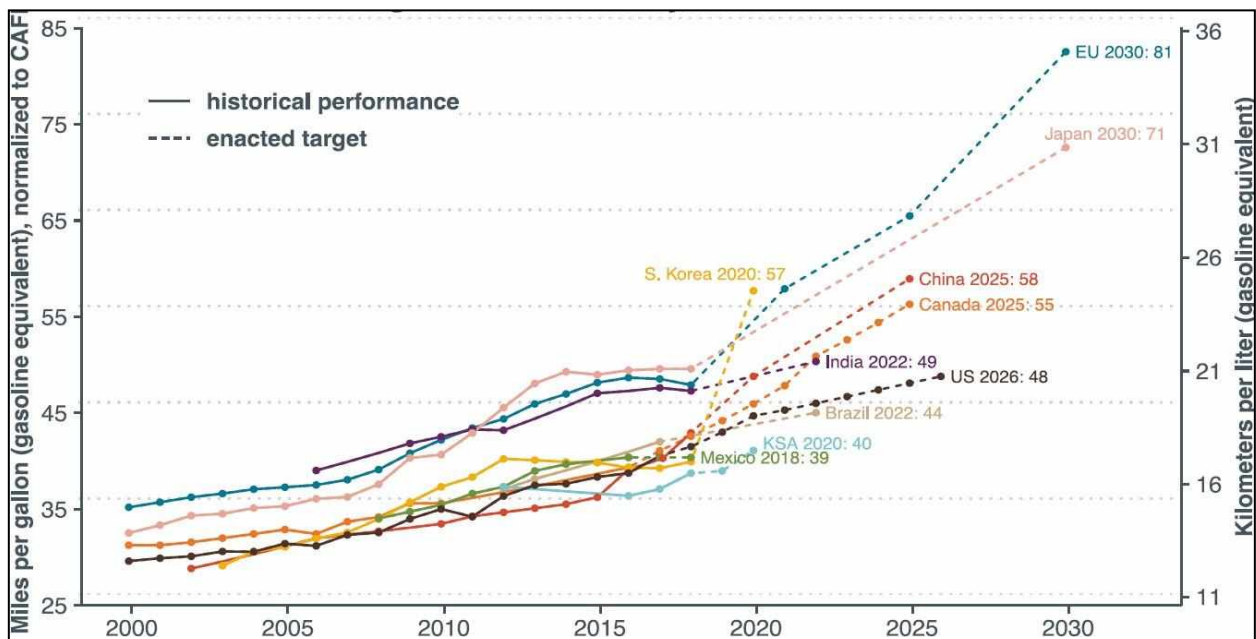

Note: Fuel economy targets for different regions as per various test cycles have been normalised to CAFÉ test cycle for easy comparison
Source: ICCT – International Council on Clean Technology, Ricardo Analysis

Historically, Japan has been a leader in passenger vehicle fuel economy followed by Europe. However, in the last five years, several countries have announced stringent fuel economy regulations leading up to 2025. For example, Europe needs to see an approximate 37% improvement between 2018-25 while China requires 46% improvement, approximately, between 2018-25. USA on the other hand must improve by only 20% between 2018-25.

Global Propulsion Split – Light Vehicle

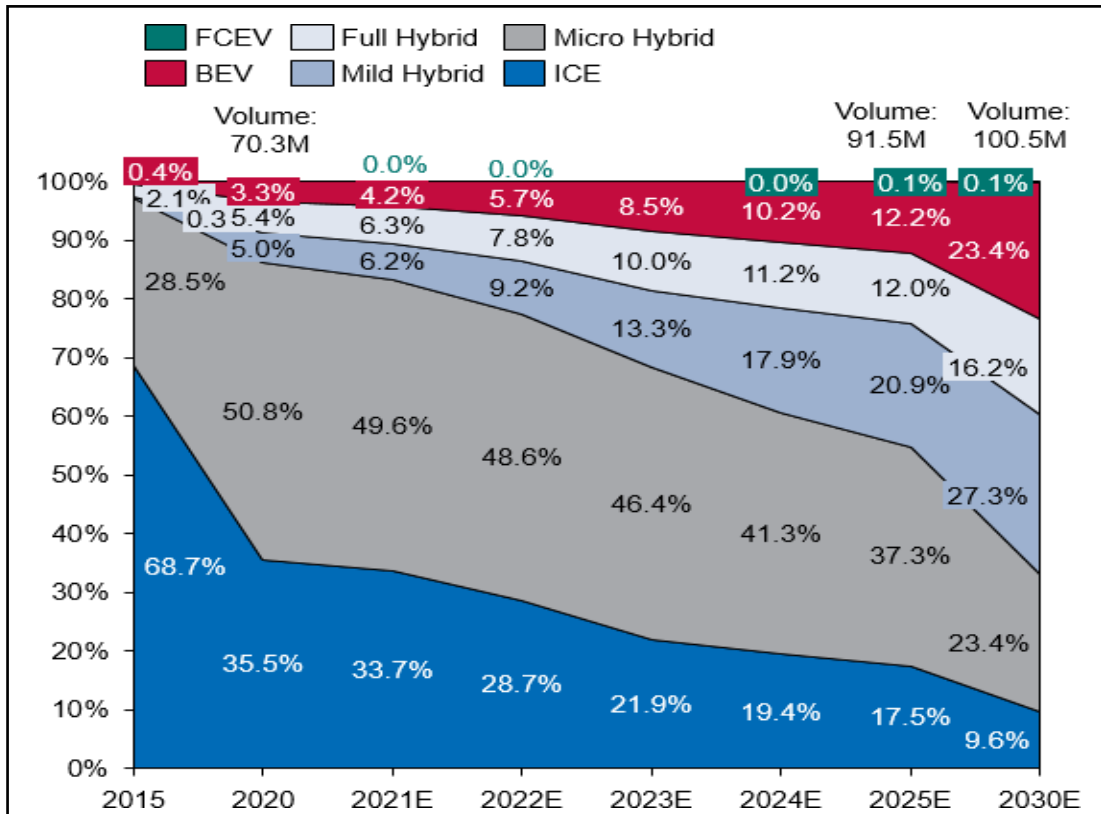

Source: Ricardo Analysis, Public Domain

Notes:

- ICE:** Vehicles with an Internal Combustion Engine are considered ICE vehicles; fossil fuels such as gasoline/ diesel are used to power ICE vehicles.
- Micro Hybrid:** Micro Hybrid is a vehicle with an integrated start/stop feature, which allows the engine to shut down when the vehicle comes to a stop and then to restart when the driver accelerates; during operation, the vehicle is propelled only by the internal combustion engine. Examples include Fiat 500, SMART car, BMW 1 and 3 series, Peugeot Citroen C3, Ford Focus and Mercedes-Benz A-class.
- Mild-Hybrid:** Mild hybrids use an electric motor alongside an internal combustion engine, but the two power sources cannot be used independently; the electric motor is used solely to assist the engine. Mild hybrids offer a simpler powertrain with modest power and efficiency gains.
- Full-Hybrid:** A full hybrid uses both the combustion engine and electric motors to drive the car, either simultaneously or independently; full hybrid normally uses a smaller engine and employs a more sophisticated control system to optimize efficiency. Examples include Toyota Prius and Camry Hybrid, Ford C-Max, Honda CR-Z and Kia Optima Hybrid.
- BEV:** All-electric vehicles (EVs), also referred to as Battery Electric Vehicles, use single power source, an electric motor instead of an internal combustion engine. The vehicle uses a large traction battery pack to power the electric motors.
- FCEV:** Fuel-cell Electric Vehicle (FCEV) is an electric vehicle that utilises a fuel cell to power its on-board electric motors; fuel cells generate electricity through compressed hydrogen and oxygen from the air.

2015 to 2020:

Share of pure ICE reduced from approximately 68.7% in CY 2015 to approximately 35.5% in CY 2020. Micro-hybrids have eventually become a standard option and their share has increased from approximately 28.5% in CY 2015 to approximately 50.8% in CY 2020. As of CY 2020, the share of Battery Electric Vehicles (“BEVs”) was limited to approximately 3.3%.

Expected trends:

As the emission and fuel economy (CAFE) norms become further stringent, pure ICE will no longer be a viable option. Depending on the stringency of CAFE norms across regions, OEMs have a choice of micro, mild and full hybrids, BEVs and FCEVs to meet CAFE norms. Mild hybrids offer a potential solution to meet FE norms between 2020-2025 and Ricardo expects BEVs to grow post 2025 as the regulations become more stringent.

2020 to 2025 outlook:

Ricardo estimates that between CY 2020 and CY 2025, the share of hybrid vehicles (micro, mild and full) in the global Light Vehicle segment will increase from 61.2% to 70.2%. Micro-hybrids are currently the standard option, but their share is likely to decline to approximately 37.3% by CY 2025. This decline will primarily be seen in Europe and China while it would be enough to meet FE norms in the US. Ricardo expects mild and full hybrids to account for approximately 32.9% in 2025 with mild hybrids being dominant. Mild hybrids offer the quickest route to electrification with limited complexity (compared to full hybrid) and substantial fuel economy benefit. Approximately 80% of mild hybrid volumes in CY 2025 will be in Europe and China. With approximately 8.4% CAGR, Ricardo expects the number of hybrid vehicles (micro, mild and full) to increase from approximately 43 million in CY 2020 to approximately 64.3 million in CY 2025. With a CAGR of approximately 37.2%, Ricardo projects that the number of BEVs will increase from 2.3 million to 11.2 million between CY 2020-25.

2025 to 2030 outlook:

Ricardo expects the share of mild and full hybrids to increase to approximately 43% in CY 2030 with mild hybrids being dominant for reasons explained above. With a CAGR of approximately 0.9%, the number of hybrid vehicles (micro, mild and full) will increase from approximately 64.3 million in CY 2025 to approximately 67.2 million in CY 2030. The share of BEVs is likely to increase from approximately 12.2% to approximately 23.4% between CY 2025-30 as FE norms become more stringent and battery cost drops to <\$100/kWh.

Except for BEVs and FCEVs, engines will continue to be used across all other categories.

REVIEW OF AND OUTLOOK OF THE INDIAN PASSENGER VEHICLE INDUSTRY

(The following has been sourced from pages 50 to 69 of the CRISIL Report).

Review of the Indian passenger vehicle industry (Fiscals 2016 – 2021)

Production of passenger vehicles (PVs) in India recorded a healthy growth of 5.2% CAGR between Fiscals 2016 and 2019 due to a spurt in domestic and exports demand. Domestic demand was driven by expansion in the addressable market, development of infrastructure, and stable cost of vehicle ownership, as crude oil prices remained low except in the few months when output was reduced due to sanctions imposed on Iran.

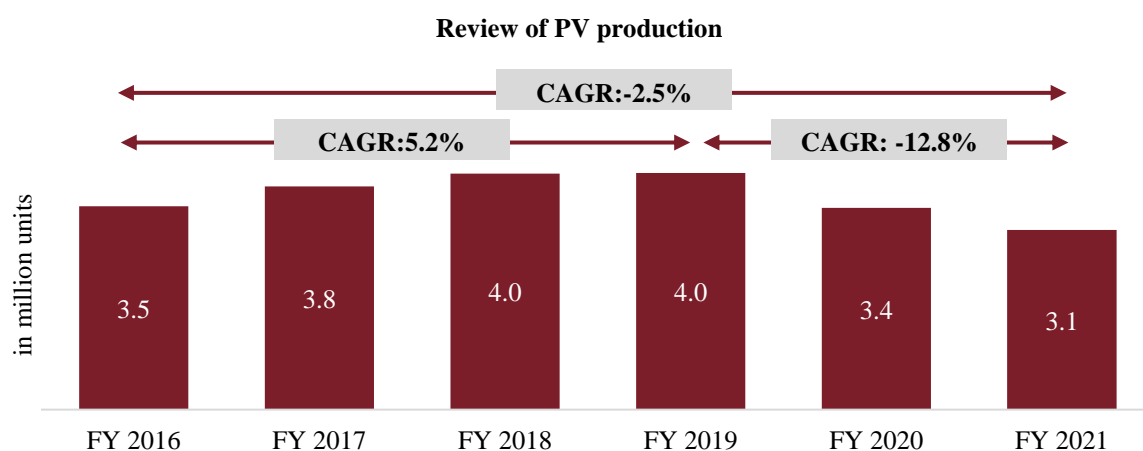

Source: SIAM – Society of Indian Automotive Manufacturers, CRISIL Research

Split by domestic sales and export

The Indian PV market is focused on the domestic market, with over 85% of demand stemming from the domestic market in Fiscal 2021.

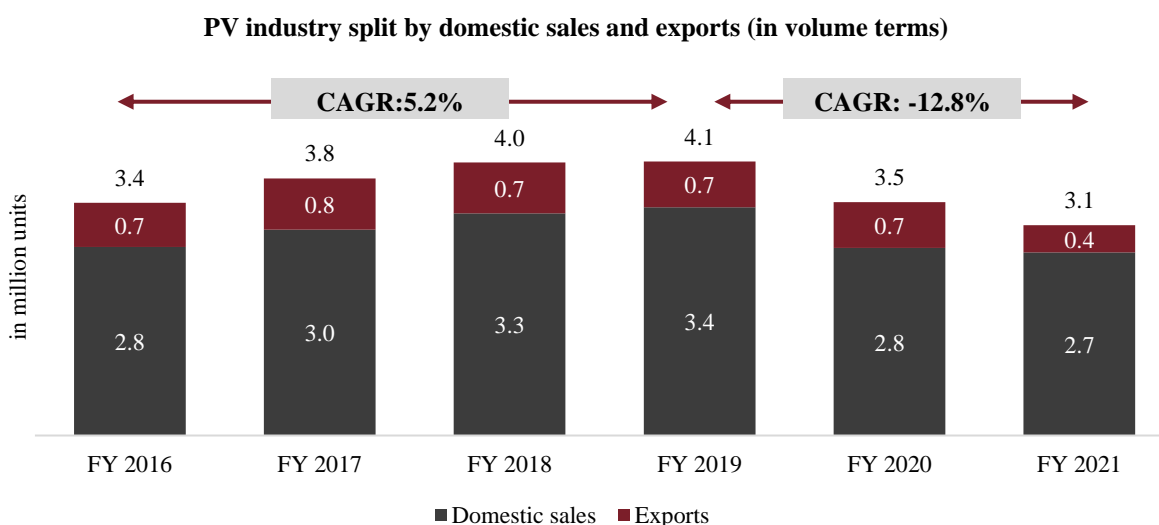

Source: SIAM, CRISIL Research

Split of industry production volume by PV segments

Small cars have a major share in total PV domestic volumes, as their lower ticket size makes them affordable for the average Indian consumer and ideal for first-time car buyers. The UV segment, which traditionally appealed to customers who valued larger seating capacity and ability to drive on rough rural roads, witnessed a major shift in customer preference with the launch

of compact UVs. The size of the large car segment has gradually shrunk, mainly due to a shift in customer preferences towards the SUV segment, few model launches and availability of high end technology features in the SUV segment as compared to the large car segment.

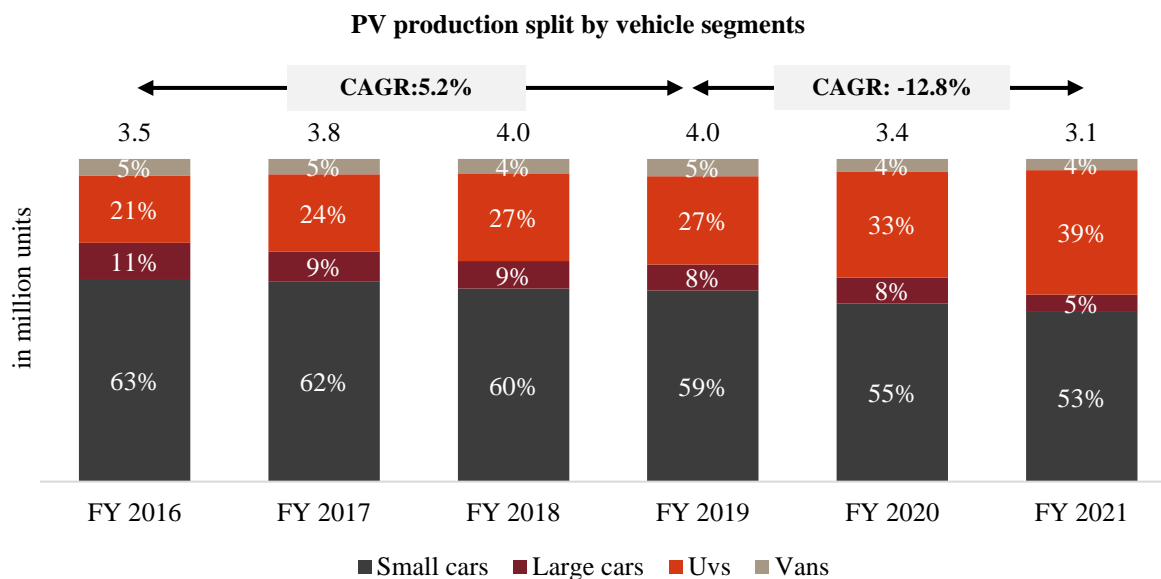

Source: SIAM, CRISIL Research

Key domestic regulations

BS-IV to BS-VI transition

BS emission standards are issued by the government to regulate the output of air pollutants from motor vehicles. In January 2016, the central government decided to skip BS-V and shift directly to BS-VI norms. It fixed the deadline at April 1, 2020 for the introduction of BS-VI emission norms.

BS-IV to BS-VI transition

Type of Vehicle	Unit	BS IV	BS VI	Change
Diesel				
HC	gm/km	0.3	0.17	-43%
NOx	gm/km	0.25	0.08	-68%
PM	gm/km	0.025	0.0045	-82%
Petrol				
NOx	gm/km	0.08	0.06	-25%
PM	gm/km	-	0.0045	Newly added

Note: HC, NOx, PM refer to pollutants from vehicle exhaust; HC- Hydrocarbon, NOx- Nitrogen oxides, PM- Particulate matter

BS-VI compliant PV price increased by 2-4%, diesel variants became costlier than other fuel variants, and the addition of various devices and systems will reduce emission levels and adversely affect prices.

Safety norms

As per the Bharat New Vehicle Safety Assessment Programme (BNVSAP) introduced from October 2017, new cars sold in India go through mandatory crash testing and comply with voluntary star ratings based on results.

While the full-frontal crash test was already implemented for new car models and LMV of GVW <1500 kg, the test was implemented for all car models from October 1, 2019. As per the rules, the car has to go through tests pertaining to full frontal crash test, 40% overall offset frontal crash test, and test of moving deformable barrier crash perpendicular into a stationary vehicle. A test pertaining to pedestrian body forms being impacted on the hood of the vehicle was implemented from October 1, 2018 for new car models. Points are awarded to the car based on safety features in the car such as ABS, seat-belt reminders, child lock, and electronic stability control (“ESC”). The government is also considering making ESC and autonomous emergency braking (“AEB”) mandatory on all models from Fiscal 2023.

Other safety systems include a mandatory air bag for the driver. The government proposes mandatory airbags for the front passenger on all cars. For new models, the front passenger airbag will be mandatory from April 1, 2021, while for models

presently being sold in the market it will be mandatory from June 1, 2021 according to the notification issued by the government.

Finance penetration

Given the industry's higher ticket sizes and the better credit profiles of end customers, finance penetration is higher in the PV industry compared with other automobile segments.

PV finance penetration – Fiscals 2016 to 2021

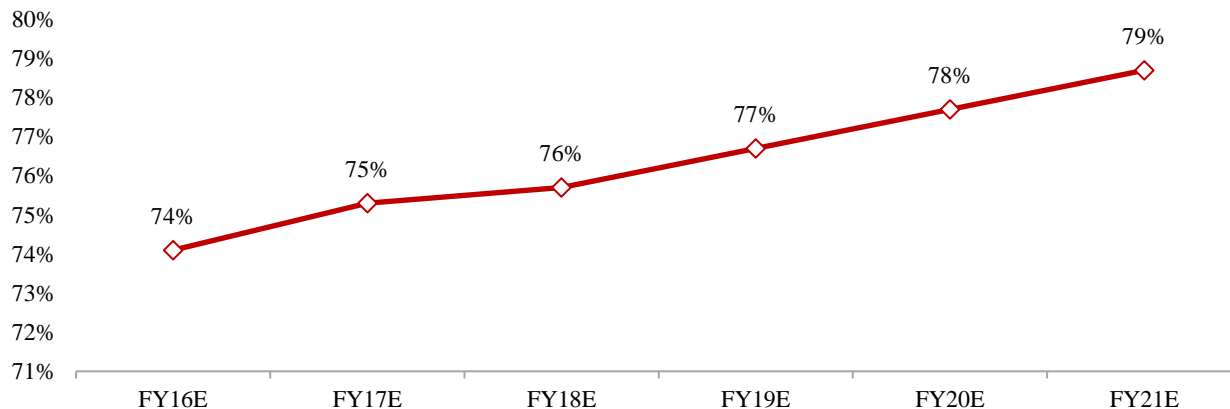

Note: E – Estimated; Note: Finance penetration indicates number of vehicles financed per 100 two wheelers sold in India
Source: CRISIL Research

Current penetration of Electric PVs

Current EV penetration in the passenger vehicle category is miniscule (0.16% as on Fiscal 2021) due to the unavailability of affordable electric cars and charging stations leading to range anxiety.

Production outlook (Fiscals 2021 – 2026P)

India’s car market is highly underpenetrated compared with most developed economies and some developing nations. As of Fiscal 2020, India had approximately 24 passenger vehicles per 1,000 people. This is significantly lower than developed nations and even other nations in the BRIC block (Brazil, Russia, and China), based on per-capita GDP. Brazil, Russia and China had 173, 307 and 99 passenger vehicles per 1,000 people respectively in 2015. Thus, the country holds tremendous potential for automobile manufacturers. Also, comparing on the basis the penetration of cars and UVs with per-capita GDP across countries, India still lags behind most countries and, as such, CRISIL Research expects the gap to reduce gradually after a decline in Fiscal 2021.

Country-wise passenger vehicle penetration

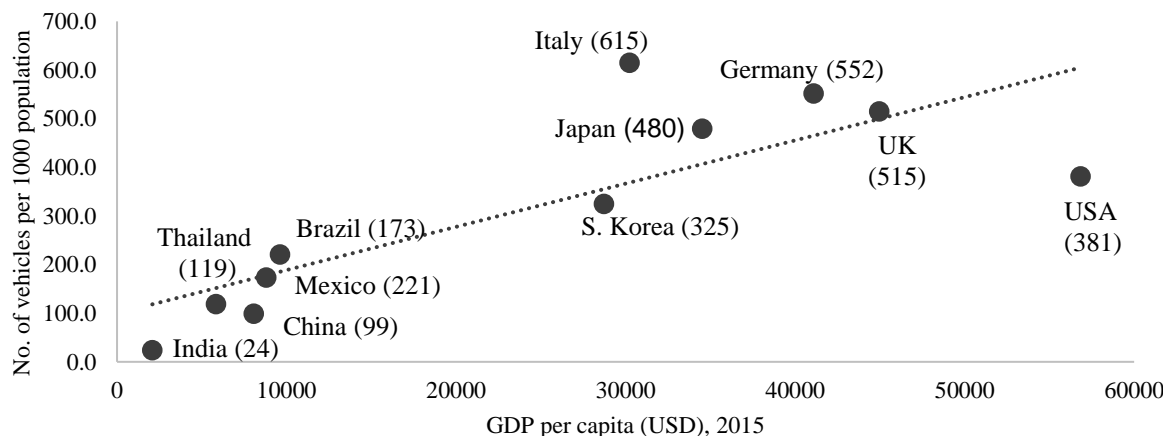

Note: Figures except India, are as of calendar year 2015; Dotted line indicates median; Figures in the bracket indicate passenger vehicles per 1,000 people
Source: OICA, World Bank, CRISIL Research

CRISIL Research estimates overall PV production to grow at a 10.8% CAGR from fiscal 2021 to 2026, and reach approximately 5.1 million units by Fiscal 2026. However, the risk of subsequent waves of COVID-19 cases and the need for the state and central governments to impose localised or extended lockdown to control the spread of the pandemic may have an impact on supply chains as well as sales going forward. In such a case, overall industry production is also likely to be adversely affected over the short term.

PV production outlook

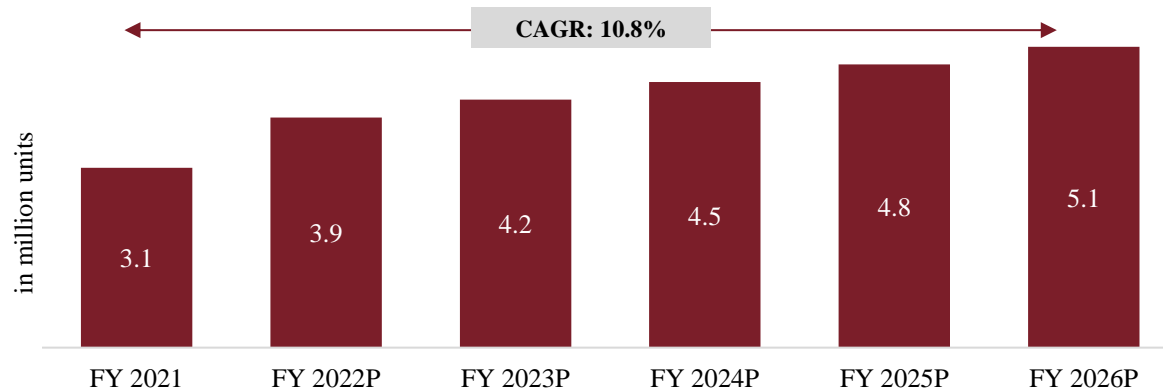

Note: P – Projected

Source: SIAM, CRISIL Research

After a consecutive drop in production in Fiscals 2020 and 2021, PV production is expected to increase at a robust pace over the next five fiscals because of a spurt in domestic as well as exports demand. Domestic demand will be driven by an expansion in the addressable market, fast-paced infrastructure development and relatively stable cost of vehicle ownership, as crude oil prices are expected to stabilize at lower levels.

The long-term outlook remains bright with regard to exports as efforts to penetrate newer geographies bear fruit and schemes such as how PLI incentivises players to tap exports. CRISIL forecasts exports to clock 12.1% CAGR between Fiscals 2021 and 2026. Rising competition in Europe amid sluggish demand growth, though, will prevent further increase in growth. Moreover, penetration of electric and hybrid vehicles will be a key monitorable.

Domestic and export sales outlook (Fiscals 2021 – 2026)

Domestic PV sales are expected to increase by 10.3% CAGR over Fiscals 2021 to 2026. Over the short to mid-term, COVID-19-induced demand for personal mobility is likely to support PV sales. Over the medium to long-term, moderate macroeconomic growth, increasing disposable income, relatively stable cost of vehicle ownership, and lower fuel prices are likely to drive demand for passenger vehicles. Other factors that would aid demand are increasing urbanisation, government support to farm incomes, and improved availability of finance. However, increasing congestion in metro cities and rising popularity of shared mobility services are likely to restrict car sales in the long term.

Domestic sales, which formed approximately 87% of total production in Fiscal 2021, are estimated to grow at 10.3% CAGR between Fiscals 2021 and 2026.

PV industry: Domestic and export sales share (in volume terms)

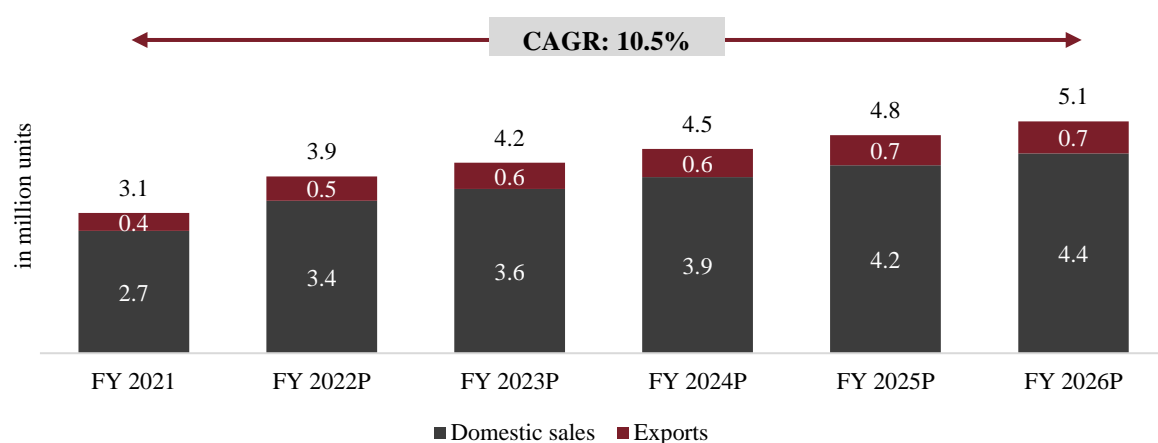

Note: P – Projected; FY 2021 figures are calculated using actual data of domestic sales and exports

Source: SIAM, CRISIL Research

While predominantly a small car exporter, India has strongly emerged as an exporter of mid-size sedans and UVs with a growing acceptance of vehicles manufactured in India.

Latin America occupies the highest proportion in PV exports from India, followed by Africa. Indian OEMs have diversified their exports by exploring newer geographies. New markets like Saudi Arabia, the UAE and South Africa have shown significant demand growth. The US, which had nil share till Fiscal 2018, garnered approximately 10% volume share as of Fiscal 2020, mainly driven by export of the Ford Ecosport.

Exports are estimated to grow at 12.1% CAGR between Fiscal 2021 and 2026 on a low base of Fiscal 2021.

Impact of regulatory changes on domestic passenger vehicle sales

Impact of corporate average fuel efficiency (CAFE) norms

Fuel consumption standards for Indian vehicles came into force in India in April 2017 for petrol, diesel, liquefied petroleum gas (LPG) and compressed natural gas (CNG) passenger vehicles. These standards are based on the CAFE system and targets to bring about improvement in fuel consumption of passenger vehicles by 2022. The policy supports a continuous reduction in CO₂ emissions through CAFE regulations.

These regulations were first implemented on April 1, 2017 with the introduction of BS-IV emission norms. It was decided that the highest permissible carbon footprint would be 130 gm per km till 2022. Thereafter, it would be further reduced to 113 gm per km. CRISIL expects this to incentivise a shift towards greener technology such as hybrids and EVs.

Upcoming regulatory changes and safety norms

The Indian PV industry has seen a host of safety and regulatory changes in the past three to five years. Implementation of CAFE norms will further help in the cleaner fuel emission. CRISIL Research expects other safety features such as electronic stability control (ESC) and autonomous emergency braking (AEB) to be implemented on all cars to reduce road accidents.

Estimated Penetration of Electric PVs by Fiscal 2026

The US and China have seen an acceleration of sales of electric/hybrid cars, as most major global original equipment manufacturers (OEMs) have one or more models in their portfolios in these countries. With more model launches by OEMs, issues of range anxiety being addressed, and declining battery prices, CRISIL Research expects electric vehicle (EV) volume to grow at a faster pace globally.

Charging infrastructure, range anxiety and lack of large OEM presence are hindering EV adoption in India. The taxi segment accounts for 10-15% of sales within passenger cars, and within the taxi segment, cab aggregators (accounting for approximately 40-50% of total sales within the taxi segment) are expected to lead adoption of EVs. This should result in an estimated approximately 25% adoption of EVs within cab aggregator segment by Fiscal 2025 (assuming adequate infrastructure is available by then).

Hence, CRISIL Research expects the share of EVs in total passenger car sales to remain low (approximately 4%) in Fiscal 2026. Penetration in Fiscal 2021 was approximately 0.16%. EV penetration can be higher if the government adopts stricter policies on OEMs for not meeting CAFE norms.

REVIEW AND OUTLOOK ON THE GLOBAL COMMERCIAL VEHICLE INDUSTRY

(The following has been sourced from pages 17 to 21 of the Ricardo Report).

Global Commercial Vehicle Market Forecast

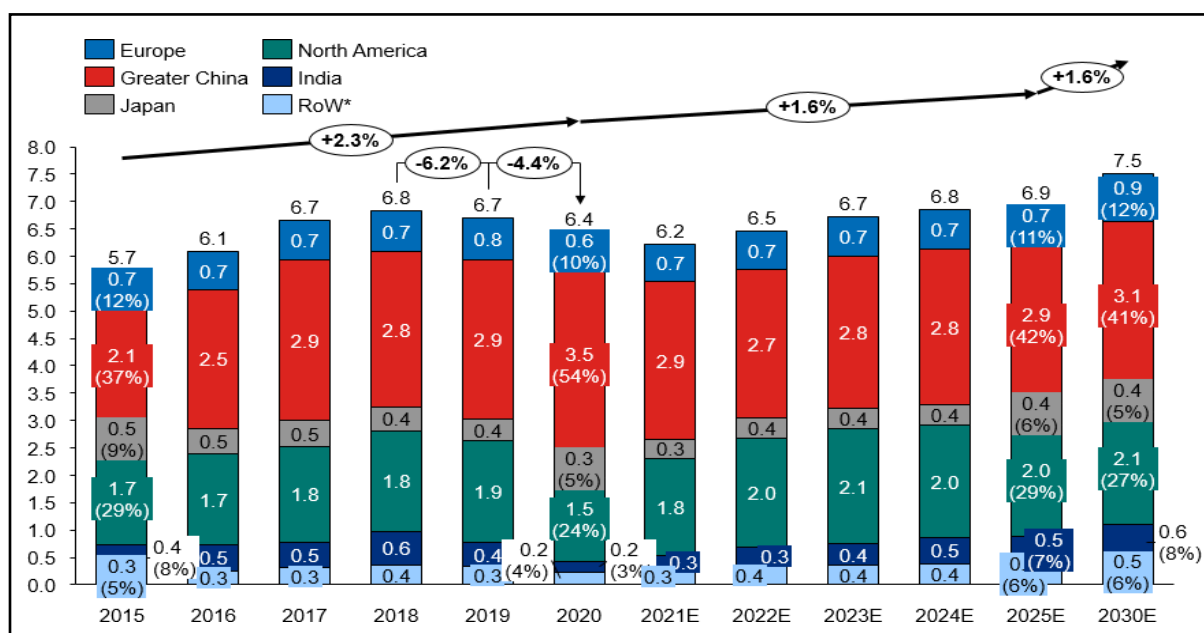

Source: Ricardo Analysis, Public Domain

Note: RoW* includes South America, South Asia and Middle East/Asia

2015 to 2020

Global CV (LCV with GVW 3.5-6T and M&HCV >6T) production grew at a CAGR of approximately 2.3% from CY 2015-2020 but saw a dip in CY 2020 due to adverse impact of COVID-19 on global infrastructure spends and halt in production. China was an outlier in CY 2020 with high replacement demand, specifically in heavy duty vehicles (China Stage III obsolescence) and medium duty vehicles (overload restrictions) driving growth.

2020 to 2025 outlook

Most markets are expected to pick up gradually in CY 2021 but a drop in China CV demand is predicted as incentives have been reduced. In Europe, CV production is not expected to reach pre-COVID-19 levels until 2025 primarily because of repeat lockdowns and delayed vaccine deployment in the region. Over the five-year period Europe will grow at a CAGR of approximately 3% to reach approximately 735,000 units per annum. At a global level, the CV market will recover to grow at a CAGR of approximately 2% over the 2020-25 period with the primary driver being the government’s focus on infrastructure spending.

2025 to 2030 outlook

Post 2025, the global CV market is expected to grow in line with GDP growth of economies with a CAGR of approximately 2%. North America and China will continue to dominate CV production with approximately 68% market share by 2030.

Global MHCV OEM Market Share – 2020

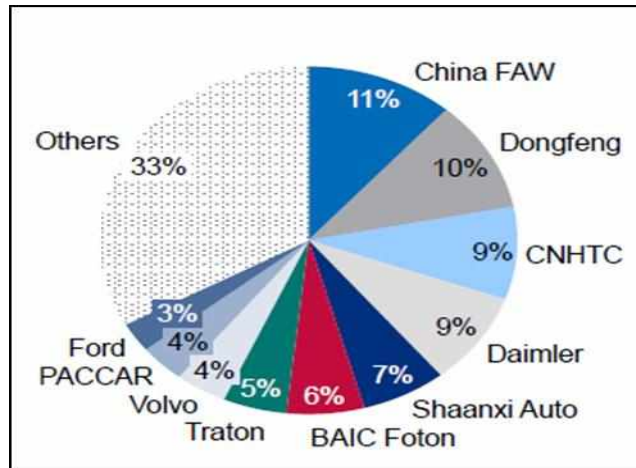

Source: Ricardo Analysis, Public Domain

Top 10 OEMs in the MHCV (includes M&HCV with GVW >6T) segment accounted for approximately 67% of the overall production in CY 2020. China FAW overtook incumbent Daimler to become global leader for MHCV segment with approximately 11% market share. Except for China, MHCV sales declined in other regions. Higher government led infrastructure spending & old truck replacement incentives led to Chinese OEMs gaining significant share and overtaking European OEMs like Volvo and Traton (MAN and Scania included).

Global Propulsion Split – Commercial Vehicle

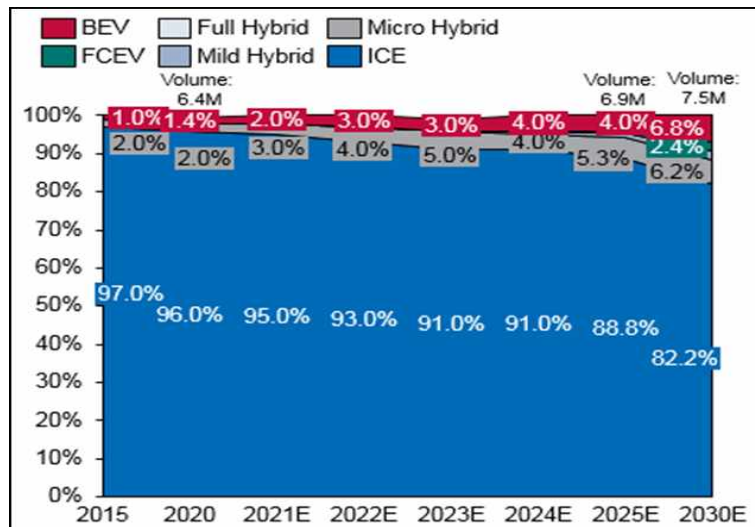

Source: Ricardo Analysis, Public Domain

2015 to 2020

With less stringent emission standards and fuel economy norms as compared to light vehicles, ICE remained the dominant technology in commercial vehicles with its share only marginally reducing from approximately 97% in CY 2015 to approximately 96% in CY 2020.

Due to high duty cycles and long mileage requirements, there is a need for large, heavy batteries for commercial vehicles. This implies that use of battery is economically unviable for commercial vehicles. However, towards 2020 pure battery driven intra-city buses have seen rise in demand particularly in regions of China and Europe. This has resulted in pure BEV market share rising to approximately 1.4% in 2020.

2020 to 2025 outlook

With increased focus on emissions and fuel economy norms, particularly driven by regulations in Europe and China, the share of ICE is expected to decline to approximately 89% by 2025. Ricardo expects the number of hybrid vehicles (micro, mild and full) to increase from approximately 0.14 million in CY 2020 to approximately 0.47 million in CY 2025. This would represent a CAGR growth of approximately 27% from CY 2020 to CY 2025. Ricardo projects share of hybrid vehicles (micro, mild and full) will increase from approximately 2% in CY 2020 to approximately 6.8% in CY 2025. Share of BEVs is projected to go from approximately 1.4% in CY 2020 to approximately 4% in CY 2025.

2025 to 2030 outlook

Post CY 2025, regulatory push to limit emissions and improve FE will drive BEV and FCEV penetration. LCVs (delivery vans) and medium duty trucks, which are used for intracity usage are expected to convert to BEVs due to lower running costs. Electrification of intra-city buses will also drive the BEV growth in China, Europe and North America.

ICE will remain the dominant propulsion technology but will drop to approximately 82% share by CY 2030. Fuel Cell infrastructure push, lower weight and space need of fuel cells compared to batteries will see FCEVs gaining popularity in long-haul trucks.

The number of hybrid vehicles (micro, mild and full) is projected to increase from approximately 0.47 million in CY 2025 to approximately 0.65 million in CY 2030. This would represent a CAGR growth of approximately 6.6% from CY 2025 to CY 2030. The share of BEVs (and FCEVs, wherever applicable) is projected to go from approximately 4.4% in CY 2025 to approximately 9.2% in CY 2030.

Except for BEVs and FCEVs, engines will continue to be used across all other categories.

EUROPE – Commercial Vehicle Propulsion Split

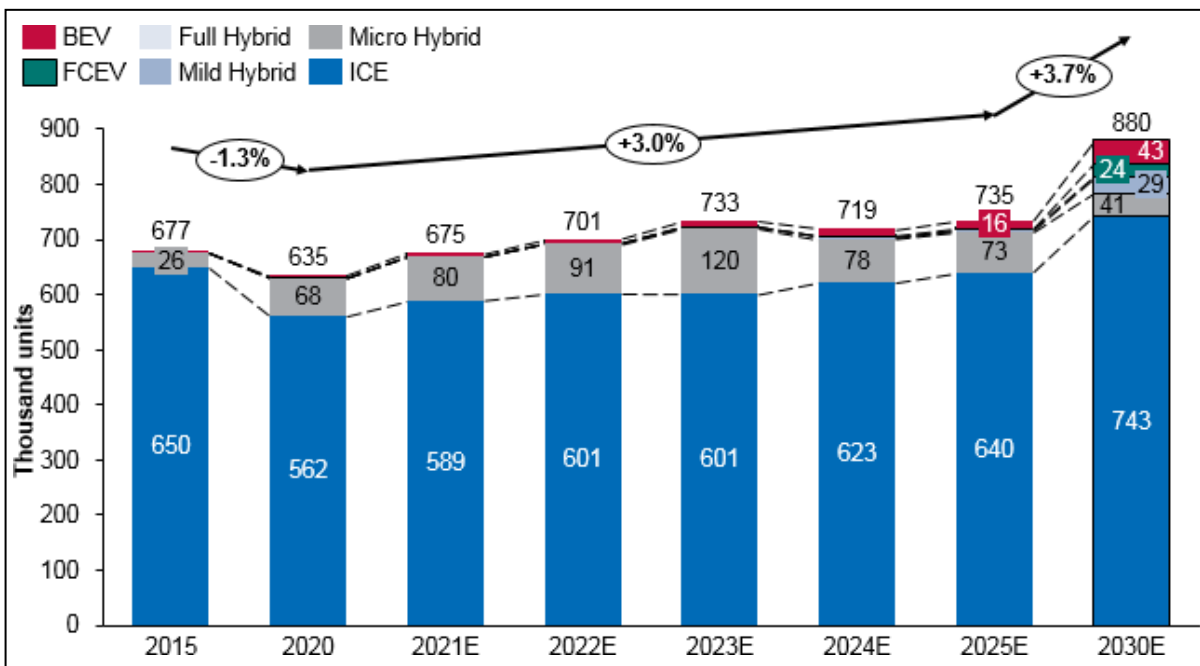

Source: Ricardo Analysis, Public Domain

2020 to 2025 outlook

Number of hybrid vehicles (micro, mild and full) to increase from approximately 69,900 in CY 2020 to approximately 78,500 in CY 2025. This would represent a CAGR growth of approximately 2.3% from CY 2020 to CY 2025. The share of BEVs and FCEVs is projected by Ricardo to increase from approximately 0.5% in CY 2020 to approximately 2.2% in CY 2025.

2025 to 2030 outlook

In Europe, ICEs will hold highest share of approximately 85% by CY 2030. BEV growth will be driven by intra-city buses as battery cost and battery weight reduce. Delivery vans and other LCVs expected to see a rise in electrification. FCEV is projected to gain approximately 3% market share by CY 2030 driven by adoption in long haul trucks closer towards 2030 with greater advancements in technology and safety aspects. Major OEMs such as Volvo and Daimler foresee application specific adoption of BEVs and FCEVs in the long term.

The number of hybrid vehicles is projected to decrease from approximately 785,000 in CY 2025 to approximately 709,000 in CY 2030. This would represent a CAGR drop of approximately 2% from CY 2025 to CY 2030. The share of BEVs and FCEVs is projected to go from approximately 2.2% in CY 2025 to approximately 7.5% in CY 2030.

REVIEW AND OUTLOOK IN THE INDIAN COMMERCIAL VEHICLE INDUSTRY

(The following has been sourced from pages 73 to 111 of the CRISIL Report).

Historic production development (Fiscals 2016 to 2021)

Production of commercial vehicles (CV) in India registered a decline of 1.1% CAGR from Fiscals 2016-2020. The production drop in Fiscal 2020 was on account of inventory correction as the industry transitioned from BS-IV to BS-VI emission norms and a tepid demand for CVs due to a general slowdown in the economy and slower government infra spending post the general election. In Fiscal 2021, production declined by approximately 17% over Fiscal 2020 as the COVID-19 pandemic and ensuing lockdown measures by the government posed severe demand as well as supply-side challenges for the industry.

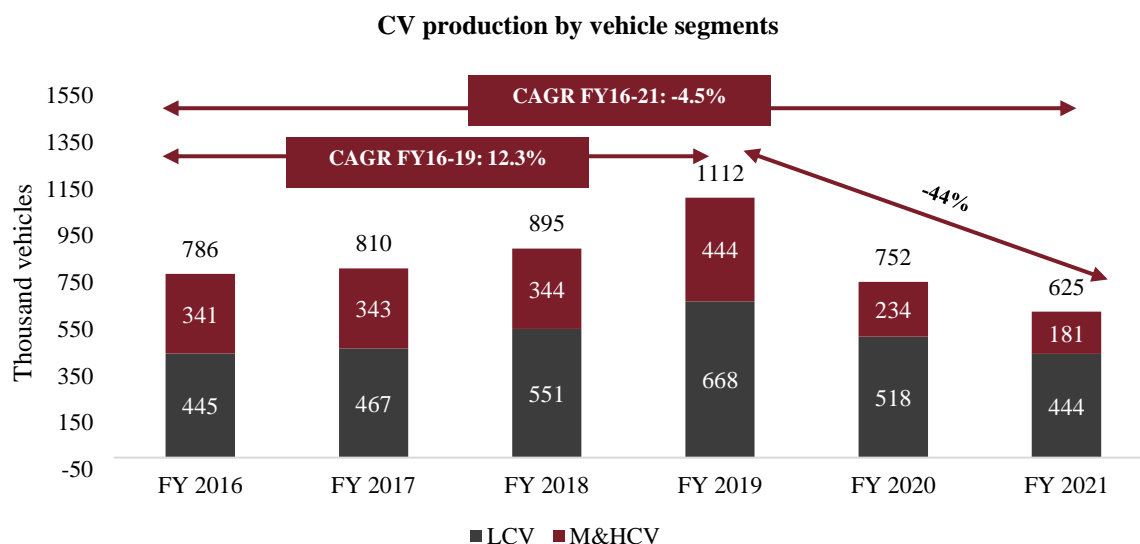

Note: LCV includes vehicles with Gross Vehicle Weight (GVW) less than or equal to 7.5 tons; M&HCV includes vehicles with GVW greater than 7.5 tons
Source: SIAM and CRISIL Research

Split by domestic sales and exports

The Indian commercial vehicle market is primarily focused on the domestic market, with more than 90% demand from the domestic market in Fiscal 2021. The Indian CV industry exports have been largely concentrated in neighbouring countries, such as Sri Lanka, Nepal, Africa, the Middle East and Bangladesh.

CV industry split into domestic sales and exports

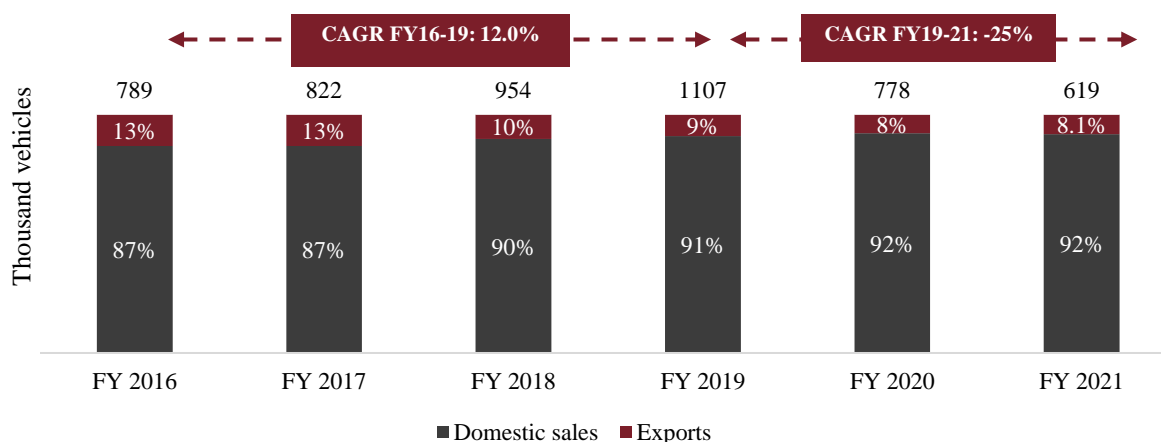

Source: SIAM and CRISIL Research

Production outlook (Fiscals 2021 – 2026P)

Production of CVs in India is expected to increase at 13.0% CAGR over Fiscals 2021 to 2026. MHCV production is expected to grow by CAGR of 16.5% and the LCV segment is expected to show CAGR growth of 11.4% in Fiscal 2026 over Fiscal 2021 production.

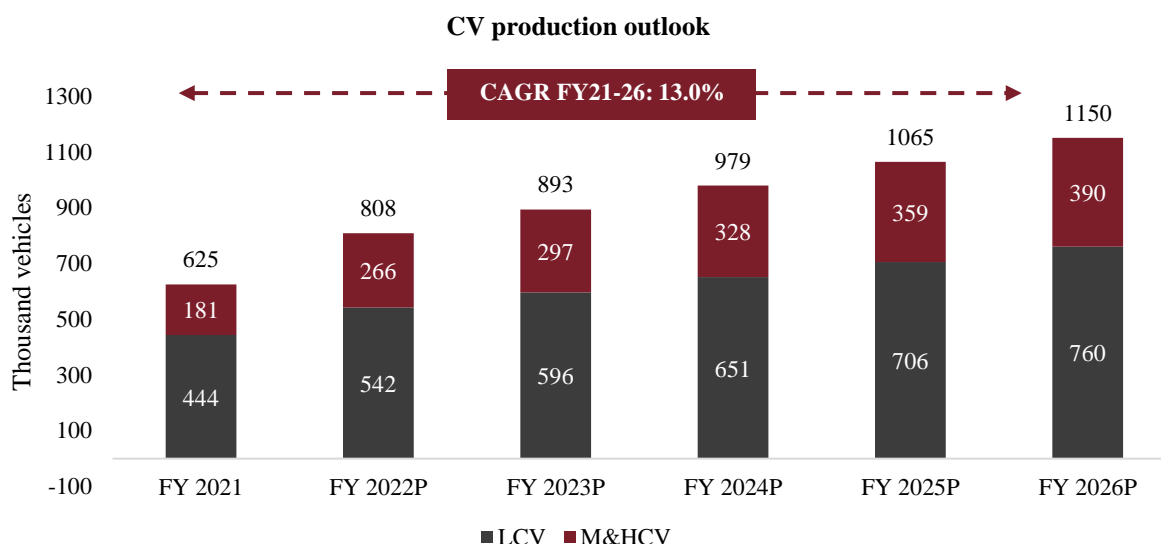

Note: LCV includes vehicles with Gross Vehicle Weight (GVW) less than or equal to 7.5 tons; M&HCV includes vehicles with GVW greater than 7.5 tons; P – Projected

Source: SIAM, CRISIL Research

Electrification in overall commercial vehicles

Electrification in overall commercial vehicle segment is expected to reach approximately 4% by Fiscal 2026 driven by electrification in LCVs and buses. EV adoption in the HCV segment is expected to be negligible in the near future as operational profile makes them prohibitively expensive. Also, the current charging infrastructure is not suitable for larger batteries of HCVs, which will render electric adoption unviable for some time.

REVIEW AND OUTLOOK FOR THE INDIAN AUTO COMPONENT SECTOR

(The following has been sourced from pages 106 to 109 of the CRISIL Report).

Indian auto component sector by value (Fiscals 2016 – 2021)

Auto component industry by OEM, export, and aftermarket in value terms

Auto component production (which includes sale to OEMs, exports, and replacement market) increased at a CAGR of 3.4% over Fiscals 2016-21, to Rs. 3,013 billion from Rs. 2,553 billion.

Auto component production split by OEM, aftermarket, and export

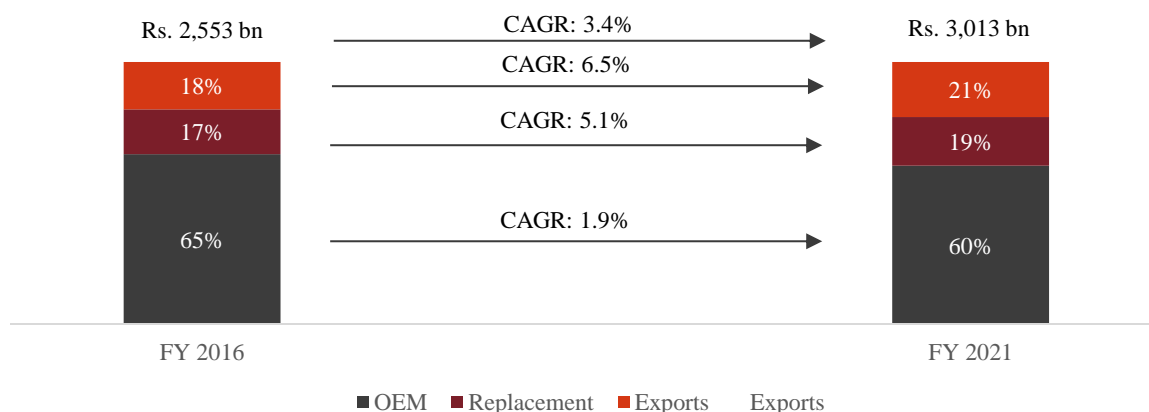

Note: E: Estimates; Market size is inclusive of demand from 2W, 3W, Cars and UVs, CVs and tractors segments
Source: CRISIL Research

Almost two-thirds of automotive components produced were consumed by OEMs in Fiscal 2016, and the remaining one-third was equally shared between aftermarket and exports. However, by Fiscal 2021, OEM share dropped to 60% as demand for vehicle segments, such as 2W, 3W, PV, and CV, has been tepid since the second half of Fiscal 2019 due to the economic slowdown. Comparatively, demand from replacement and export has remained resilient. As a result, their shares have increased over Fiscals 2016-21.

Split by major auto component categories in value terms

Segment-wise production break-up in Fiscal 2021E

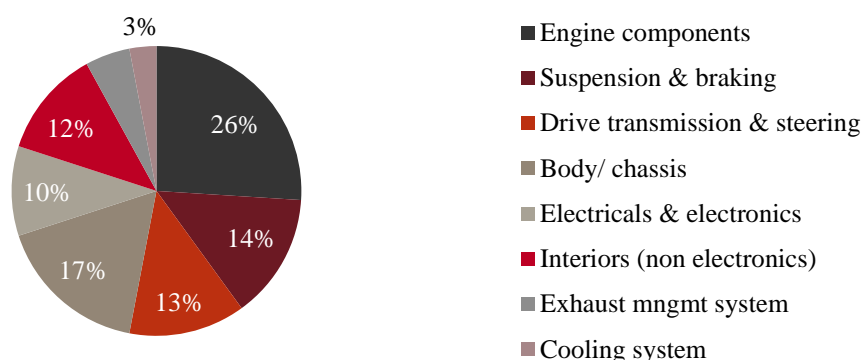

Note: E – Estimates
Source: Automotive Component Manufacturers Association (ACMA), CRISIL Research

The Indian auto component industry can be broadly classified into organised and unorganised sectors. The organised sector caters to the demand for high-value precision instruments such as engine parts, and the unorganised sector to the aftermarket with low-value products such as switches.

Engine component manufacturing is technology- and capital-intensive in nature, which acts as an entry barrier especially for smaller players and the unorganised segment. Over the years, the industry has developed the capability to manufacture the entire range of auto components required for vehicles engine parts, which constitute 26% of production, mainly comprising pistons, engine valves, carburettors, fuel injection systems, camshafts, crankshafts, connecting rod, and rocker arm.

Critical components, such as engine parts, drive transmission and steering, and electricals, are technologically more complex compared to other auto component parts.

Engine and engine parts	Suspension and braking parts	Drive transmission and steering parts	Body chassis and	Electrical and electronics parts	Interiors (non-electronics)	Exhaust management and cooling systems
Piston and piston parts	Suspension parts	Steering system	Sheet metal parts	Starter motors	Seating system	Exhaust pipes
Fuel injection equipment and carburettors	Braking parts	Axle assembly	Fuel tanks	Generators	Mirrors	Mufflers
Powertrain components (crankshaft, connecting rod, cylinder heads, cylinder blocks)		Clutch assembly	Plastic-moulded components	Alternators	Plastic-moulded components	Catalytic convertors
Engine cooling systems		Wheel and wheel rims	Rubber components	Flywheels	Rubber components	Radiators
Other powertrain components			Locks	Magnetos		Cooling fans
Engine bearings and valves			Ball and roller bearings	Distributors and regulators		
Exhaust systems						
Gaskets, liners, and filters						
Other engine parts						

Source: CRISIL Research

Auto components exports by value over Fiscals 2016-21

India exports auto components mainly to North America and Europe (which together account for over 50% of exports).

Exports increased at a CAGR of 14.1% over Fiscals 2016-19, in line with improvement in global automobile sales. However, global economic slowdown and increasing trade tensions led to a 5.9% decline in exports in Fiscal 2020. On the export front, the industry witnessed the lowest decline (-2.0%) among all segments in Fiscal 2021 due to better sentiments in the key export markets of North America and Europe.

Auto component export development (Rs. billion), Fiscals 2016-21

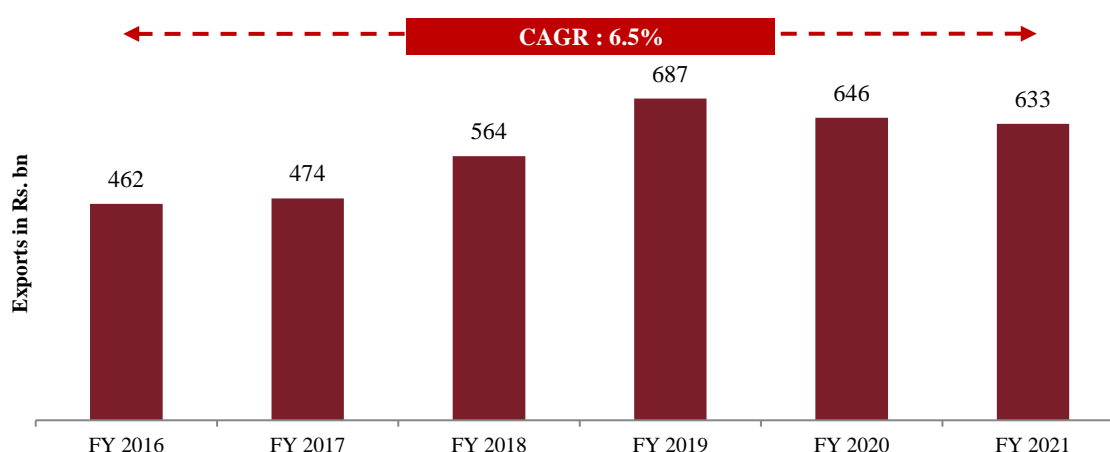

Source: Directorate General of Foreign Trade, CRISIL Research

Outlook of Indian auto component sector in value terms (Fiscals 2021 – 2026P)

Auto component industry by OEM, export, and aftermarket in value terms

CRISIL Research expects the auto component industry's revenue to be led by OEM demand, which is expected to log a CAGR of 11.9% over Fiscals 2021-26 to reach Rs. 5,284 billion. Production growth and higher outsourcing to auto component players by OEMs will drive OEM demand.

The share of auto component players is expected to increase in the future because of their growing technological spend. CRISIL

Research expects localisation by certain OEMs to increase further, supporting growth in domestic OEM offtake.

Auto component production split by OEM, aftermarket, and export

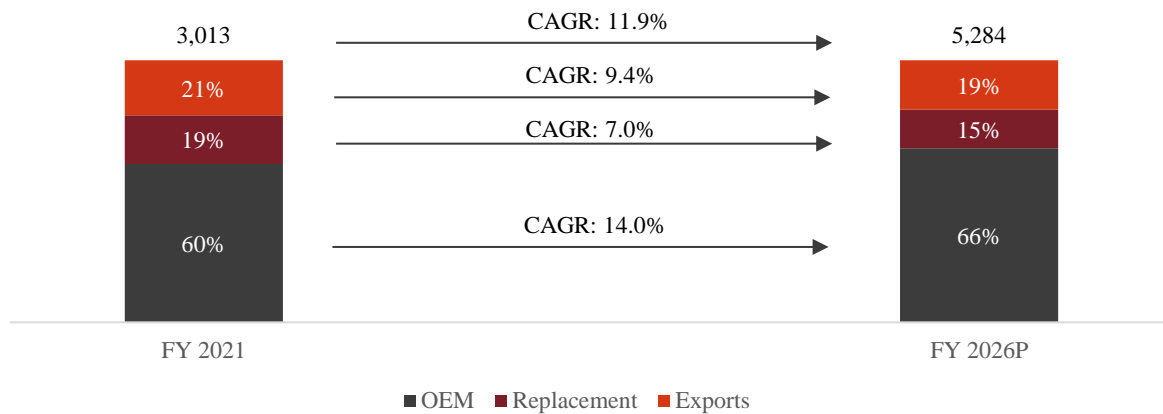

Note: P: Projected; Market size is inclusive of demand from 2W, 3W, cars and UVs, CVs and tractors segments
 Source: CRISIL Research

Exports are expected to increase at a CAGR of 9.4% over Fiscals 2021-26, driven by schemes such as the Production-Linked Incentive. CRISIL Research expects exports to benefit in the long term from Indian safety and emission norms approximating global standards, and domestic companies gaining technological capabilities through joint ventures.

Replacement demand is expected to remain stable and grow at a 7.0% CAGR over Fiscals 2021-26. Expectation of robust new vehicle sales will be offset by manufacturing of improved components with a better life cycle. Therefore, the requirement to replace a component due to wear and tear will decline.

Split by major auto component categories in value terms

Segment-wise production break-up in Fiscal 2026P

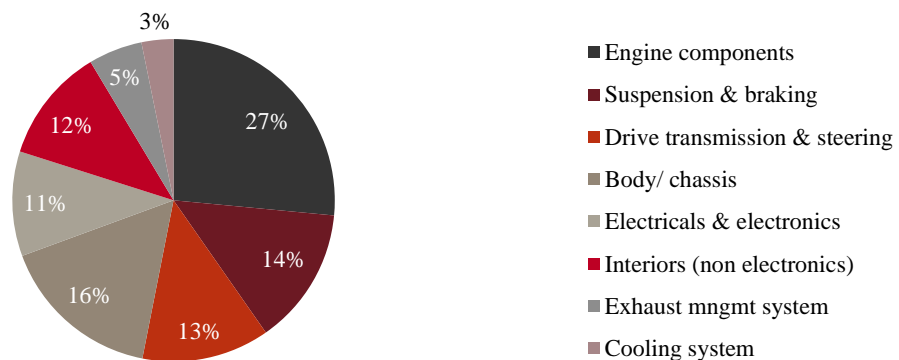

Note: P – Projected
 Source: CRISIL Research

REVIEW AND OUTLOOK OF NON-AUTOMOTIVE INDUSTRY

(The following has been sourced from pages 116 to 119 of the CRISIL Report).

Review and outlook on the aircraft industry

Review of deliveries by Airbus and Boeing

Hospitality and tourism was one of the worst-affected sectors in the pandemic. Demand plunged and losses mounted as entry restrictions in various countries and a shift towards work-from-home roiled the sector. By the end of 2020, airlines were operating at 50-60% capacity.

Deliveries of commercial aircraft by Airbus and Boeing (CY2015-2020)

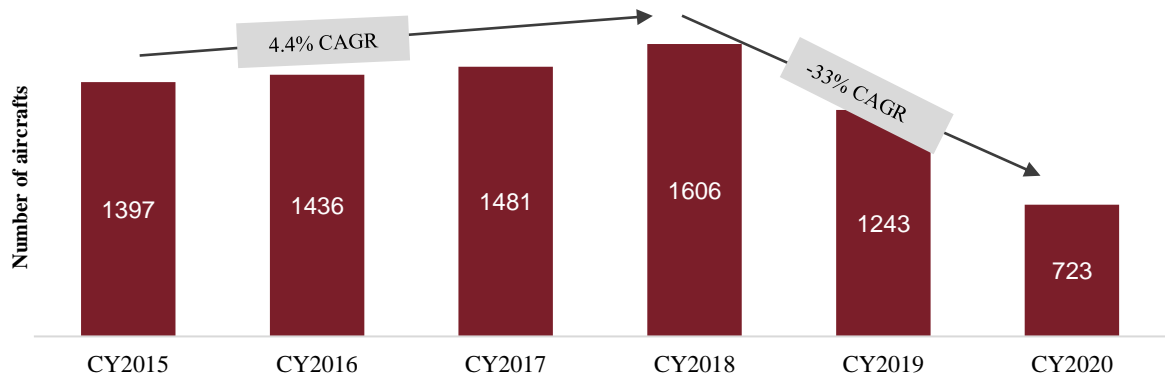

Source: CRISIL Research, Airbus and Boeing publications

Commercial aircraft delivery outlook for Airbus and Boeing

Fleet renewal is likely to be the main driver of order books for Airbus and Boeing till 2025. China and India are expected to be the first and third most important markets by delivery value. Overall, aircraft deliveries are expected to clock 10-12% CAGR till CY 2025 over a low base of CY 2020.

Delivery outlook of commercial aircraft by Airbus and Boeing (CY2020-25)

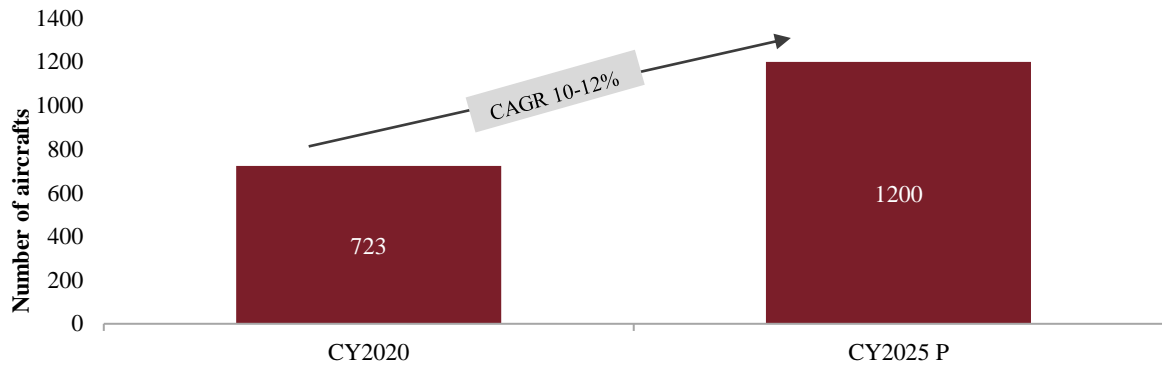

Source: CRISIL Research

Review and outlook on the ATV industry

Review of ATV industry in the US

Honda introduced all-terrain vehicles (ATVs) in the US in 1971. Given a booming market, several players such as Yamaha, Kawasaki and Polaris also entered the ATV market. The US market accounts for over 50% of worldwide ATV demand due to its large stretches of natural terrain, unpaved roads, and large ranches and farms across the country.

The most popular ATV use is for general recreation, followed by farming/ranching, hunting/fishing, hauling/towing, transportation, and commercial use.

ATV sales development in the US (CY2015-20)

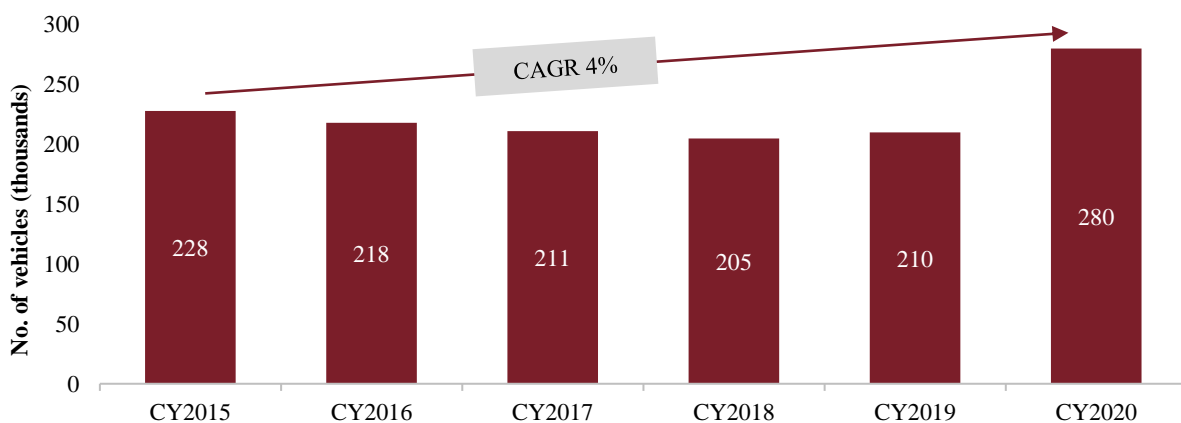

Source: CRISIL Research, Yamaha Industry publications

Between 2015 and 2019, ATV sales declined at 2% CAGR on growing concerns over rider safety. An increase in the number of deaths and injury cases led to requests for a ban on ATVs in protected areas to prevent damage to the ecosystem.

ATV sales spiked 33.8% in the US in 2020 on increased interest in recreational activities, a rise in rural demand for ATVs as a replacement for bikes, and increased demand for ATVs in agriculture and defence. Consumer interest in outdoor activities also picked up following long lockdowns.

Outlook of ATV sales in the US

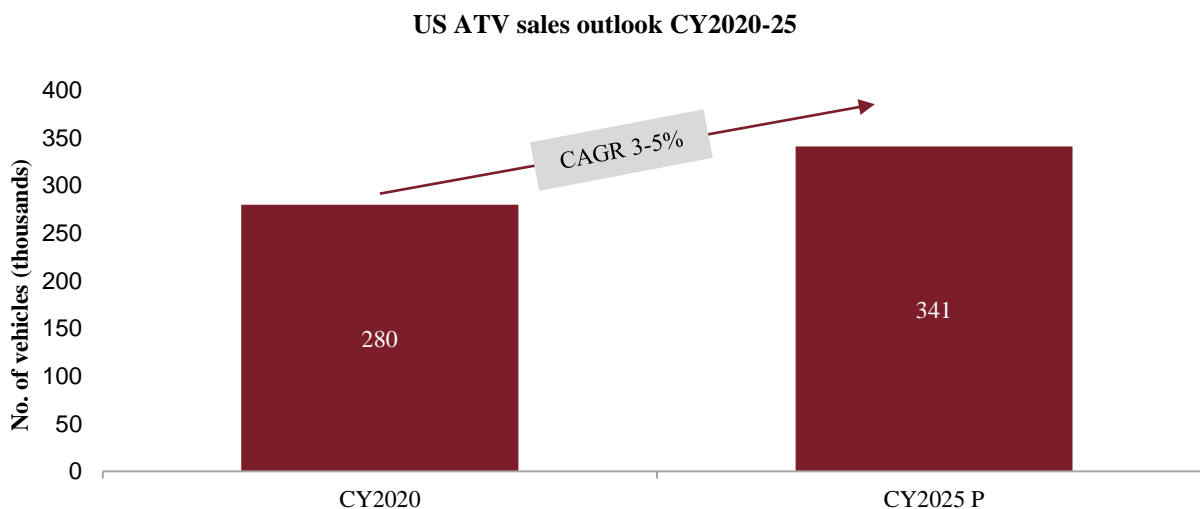

Source: CRISIL Research, Yamaha Industry publications

Factors such as a growing interest in recreational activities, worldwide championships, construction of dedicated trails for ATVs, increased acceptance in military applications, and increased safety requirements are likely to increase the demand of ATVs in the US. On a high base of 2020, ATV sales are projected to grow at a moderate 3-5% CAGR till CY2025. ATVs with more than four wheels are projected to be the fastest growing segment in the all-terrain vehicle market by 2025. A growing number of ATV buyers are looking for ATVs with more than four wheels, especially in military and agricultural applications.

ASSESSMENT OF INDIAN PRECISION ENGINEERING INDUSTRY

(The following has been sourced from pages 143 to 185 of the CRISIL Report).

Overview of Indian precision engineering industry

The Indian engineering industry is divided into two segments, heavy and light, based on the nature of the product and the technology used for processing. Heavy engineering includes manufacturing and assembly of industrial machinery and plant equipment for various end-use sectors. Equipment are designed and manufactured to suit end-use applications for process industries such as fertiliser, textile, chemical, refinery, petrochemical, and oil and gas (O&G), and for the thermal and nuclear power sectors. While, light engineering includes sub-sectors, manufacturing, everything from basic to sophisticated equipment. Light engineering products (components, parts and small equipment) find application in automobiles, industrial machinery, power, O&G, fertilisers, steel, refineries, petrochemicals, cement, and railways sectors, and serve as inputs for the heavy engineering and capital goods sectors.

Precision engineering: Sub-discipline of manufacturing with high accuracy, stress on low tolerance for error

Precision engineering is a sub-discipline of engineering, concerned with manufacturing and assembling items with exceptionally low tolerance and are required to perform consistently over longer repeat cycles. Accuracy and margin of error are crucial for engineering and production. Any deviation in dimensions can lead to loss of performance or even catastrophic failure of the system.

Typical tolerance in various engineering products ranges from millimetres (10^{-3} meter) to microns (10^{-6} meter). Precision engineering products have tolerance in the range of less than 10 microns. Low tolerance is important for precise fit, accuracy and efficiency in performance, along with consistency over several repeat cycles.

Precision engineering is extremely critical in several applications, such as automotive engine components, defence, aircraft, capital goods and power generation.

Machining operations for precision engineering products

Machining capabilities	5- and 6-axis milling, multi-spindle long-bed milling CNC turning up to 9-axis, vertical machining centre, horizontal machining centre Drilling and boring Grinding Planning Honing Broaching
Surface treatments	Anodising Hard chrome plating Nickel plating Induction hardening
Heat treatment and cooling facilities	Annealing, case hardening, precipitation strengthening, tempering, carburising, normalising and quenching
Assembly	Special application tools for each type. Assemblies and sub-assemblies are built at the assembly station, which requires precise fitting operations and clean rooms to avoid contamination due dust and other external particles that may impact fitting. Error-proof structure assembly is critical for precision components.
Other special processes	Coating processes, such as bonding, plating or painting, pre-treatment before coating, finishing processes to remove machining marks, scaling or pitting, deburring, burnishing, abrasive blasting to improve hardness, etc.
Quality control and measurement	Inspection and calibration tools - precision, measuring and marking, non-destructive testing (fluorescent and magnetic), universal compression rig for shock absorber testing, universal hydraulic test rigs, specific tooling for testing actuators and nose-wheel steering (aircraft)

Source: CRISIL Research

Precision engineering players cater to select end-use sectors and have developed expertise in that space. The value chain comprises three broad segments of suppliers for automotive and non-automotive sectors (defence, engineering and capital goods, power, aircraft and other niche applications such as for tractors, construction equipment, railways, medical applications, etc.). Players exclusively cater to the automobile sector's requirements due to the scale of volume and location preference near the assembly or automobile plant/cluster. Applications, such as defence, nuclear, aircraft and marine, which require high material performance and special material properties, are serviced by suppliers with expertise in these niche applications.

Precision engineering industry is projected to log a 10.2% CAGR between Fiscals 2021 and 2026

The precision engineering industry will benefit from supportive government policies for manufacturing and engineering sectors. Further, growth in the machinery and equipment industry and rising penetration of high technology machinery for manufacturing would contribute towards the industry's growth. CRISIL Research expects precision engineering to log a 10.2% CAGR between Fiscals 2021-2026 to reach Rs. 5,925 billion. Growth in domestic auto-components and export demand, and indigenous manufacturing in the defence segment would aid the industry's growth.

Review and outlook of the precision engineered component industry across segments

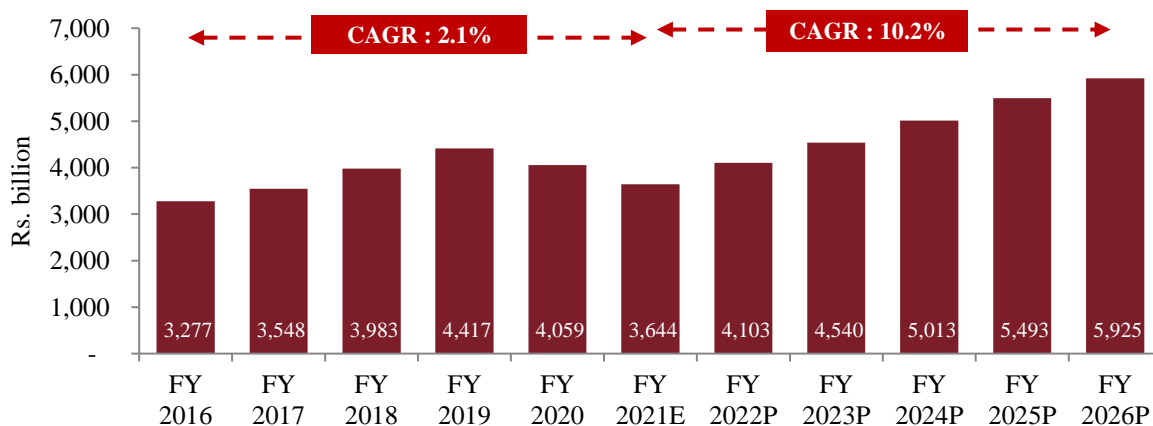

Note: P – Projected
Source: CRISIL Research

Share of automotive set to increase in the precision engineered component industry

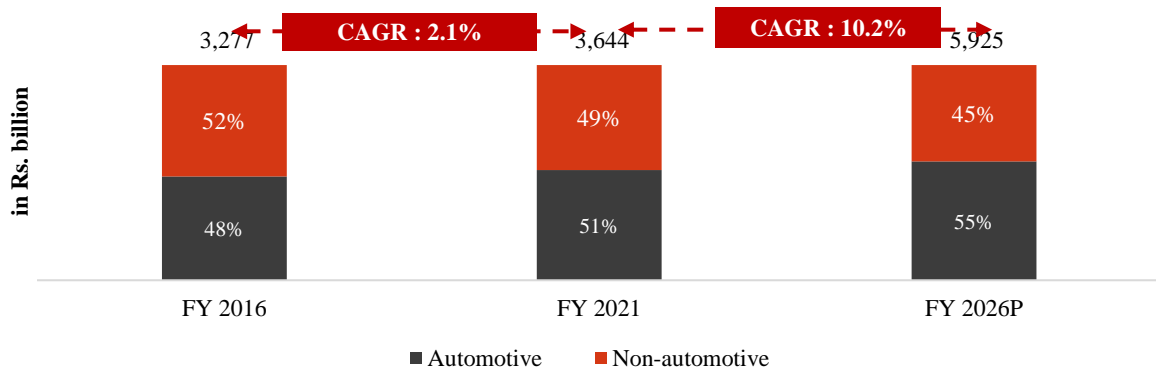

Note: Non-automotive includes defence, engineering and capital goods, power, aircraft and other niche applications such as tractors, construction equipment, railways, medical etc.

Source: CRISIL Research

Share of end-use segments

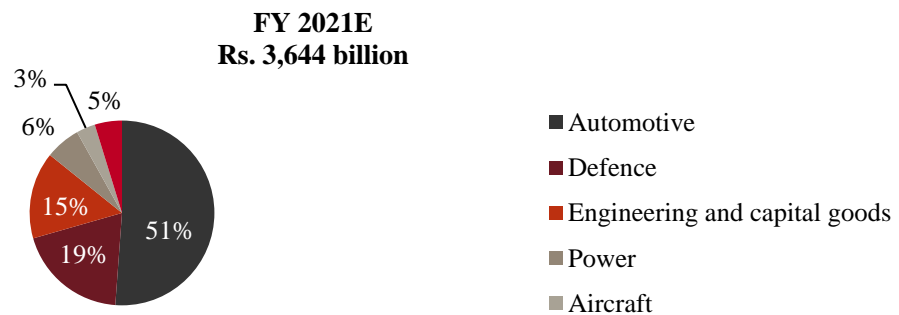

Note: Engineering and capital goods include machinery and equipment components demand from industrial segments, such as textile, metallurgy, process controls equipment, cement, mining, agro equipment, etc. Others include equipment and components demand from medical, construction equipment, railway locomotives, refinery segments, tractors and others.

Source: CRISIL Research

Automotive segments have the largest share in precision engineering, followed by defence and engineering capital goods.

Precision engineering in automotive industry

Manufacturing of precision automotive components is a multi-step, complex process, requiring high performance and extremely high precision. Since the vehicle comprises various sub-systems, all components should be precision engineered to ensure they fit together properly and function efficiently.

Approximately 60-70% of automotive components manufactured are precision engineered, specifically, engine parts, suspension, steering parts, electrical parts, etc.

Review and outlook of precision engineering market size in the automotive industry

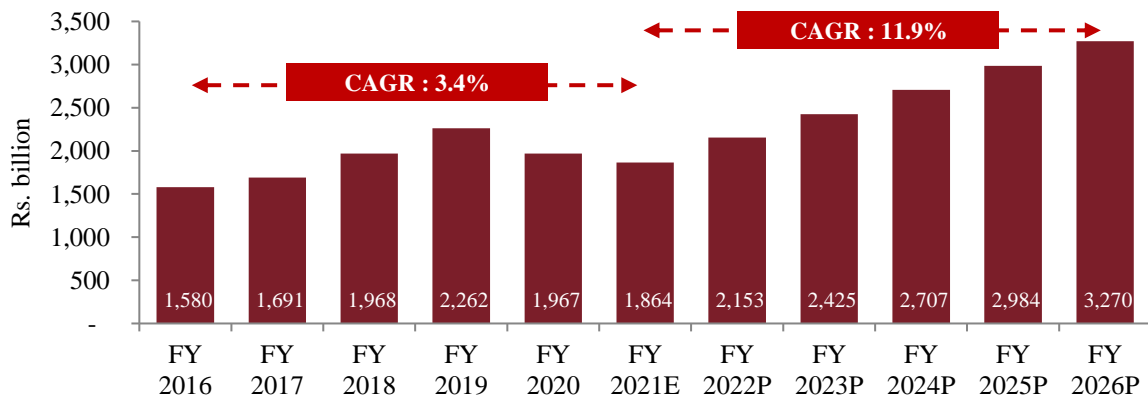

Note: E – Estimated; P – Projected

Source: CRISIL Research

Precision engineering in the non-automotive industry

Review and outlook of precision engineering market size in the non-automotive industry

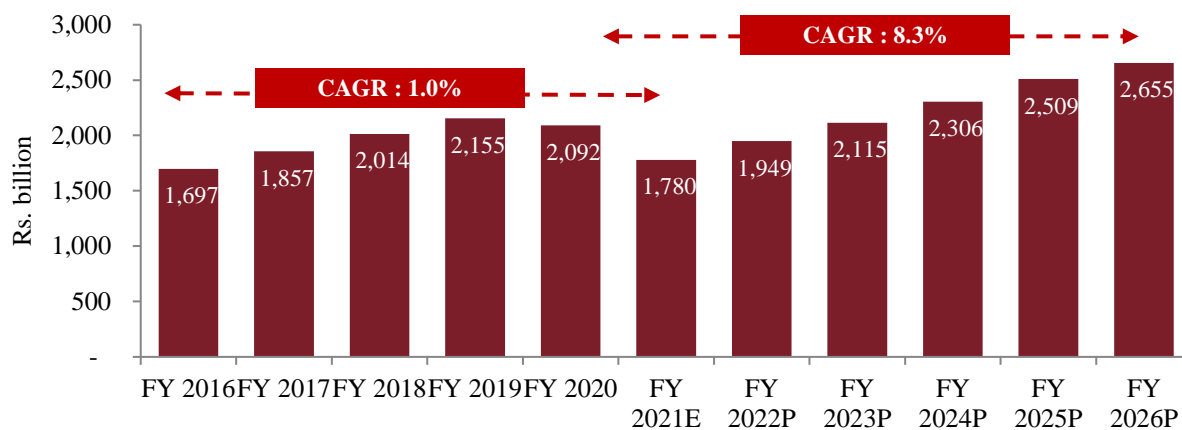

Note: Non-automotive includes defence, engineering and capital goods, power, aircraft and other niche applications such as tractors, construction equipment, railways, medical, etc.

Source: CRISIL Research

Precision engineering in the defence industry

The defence (including aerospace for defence) industry is the second-largest consumer of precision engineering (19.4% share as of Fiscal 2021), following the automotive industry.

Precision engineering is critical for defence (including aerospace for defence) equipment, as a failure of even a small fitting component can lead to catastrophic results. Components of equipment in this segment require high material performance and special material properties, which are serviced by suppliers with expertise in these niche applications.

Components such as artillery systems, land and naval weapon systems, fire control systems, maritime equipment and systems, underwater platforms, engineering systems for land and marine forces, uncrewed aerial vehicles (UAVs), remotely piloted vehicles, autonomous programmable vehicles - C4I (command, control, communications, computers and intelligence) systems, and missile systems, radar systems, ball screws, and electro-mechanical actuator are precision engineered.

Precision engineering in engineering and capital goods

Capital goods industry is the third-largest consumer of precision engineering after automotive and defence industry. It is estimated to have a share of 15.2% in the precision engineering market in India as on Fiscal 2021.

Heavy electrical engineering occupies the largest pie (>50%) within the capital goods industry. Production of electrical equipment witnessed robust growth in the past few years, driven by growth in power distribution and transmission equipment such as transformers, conductors, meters, cables and switchgears on the back of government enhancing transmission capacity and pushing states to improve the distribution network.

One of the sub-sectors within capital goods is Machine tools which includes Special Purpose Machines (“SPMs”). Other sub-sectors include process plant equipment, earth-moving and mining machinery, printing machinery, dies, moulds and press tools etc.

Review of special purpose machine manufacturing

SPMs are customised machines deployed to automate industrial processes to ensure high productivity. Designed to operate for 24 hours a day with minimum supervision, SPMs are mostly product-specific and need to be designed and developed as per individual requirements. Based on their usage, they are classified as general purpose machines or SPMs. Usage of SPMs reduces chances of human error and decreases human fatigue when carrying out repetitive operations. It assures consistent quality and interchangeability of parts by carrying out the same designed process every time without any shortcuts.

SPMs are either cam-operated machines or use hydraulics and pneumatics as actuating elements or a combination of all. Often, a dedicated programmable logic controller is used in conjunction with positional sensors and transducers to give commands to the actuating elements. Sometimes, different special motors such as stepper and servo motors are used as actuating elements.

Since SPM manufacturers are mostly machine tool manufacturers, SPMs are considered a part of the machine tools industry. However, not all machine tool manufacturers possess the capability to produce SPMs since these require strong design expertise, technical know-how, and industry knowledge.

Only players with skilled manpower and design capabilities manufacture SPMs. SPMs are wide-ranging in terms of function and scale, resulting in players producing specific SPMs. While competition is high in the manufacture of less complex SPMs,

machines requiring high precision and design standards are produced by few manufacturers in India, providing them higher bargaining power. SPM manufacturers in Bengaluru command a premium over other regions due to the superior design and quality of the machines.

Precision engineering in aircraft industry

The Indian aircraft industry is still at a nascent stage. The growing passenger numbers and a burgeoning middle class indicate the possibility of healthy growth in passenger traffic for major airlines in the future. A buoyant market growth rate, coupled with the expansion of infrastructure, is likely to help the Indian civil aircraft industry grow at an accelerated pace.

Growth drivers in aircraft industry in India

- The commercial aircraft fleet is expected to increase from the current 600-700 aircrafts to over 1,000 aircrafts over the next four to eight years due to rising passenger traffic.
- Boeing to procure components from over 200 Indian suppliers that are involved in manufacturing of critical systems and components, such as aero-structures, avionics mission systems, composites, forgings, wire harness, and ground support equipment, for some of its commercial and defence aircraft.
- Airbus is also planning to add new suppliers to its 45+ supplier base in India and looking at developing a supplier base to support its partnership with Indian Air Force, along with Tata for supplying transport aircraft.
- Recently, global aerospace manufacturers, Boeing and Lockheed Martin, have shown interest in manufacturing aircraft in India, based on the outcome of India's aircraft acquisition plans. This could boost domestic production and exports at the tier I level as well.
- FDI up to 100% permitted on automatic route.

Aircraft are subject to harsh treatment from humidity, extreme weather conditions, rapid changes in thermal and air pressure. Engine components, avionics (electrical systems such as navigation, communications, etc.) sensors, airframes, connectors and seating parts are precision engineered.

Review and outlook of precision engineering market size in aircraft industry

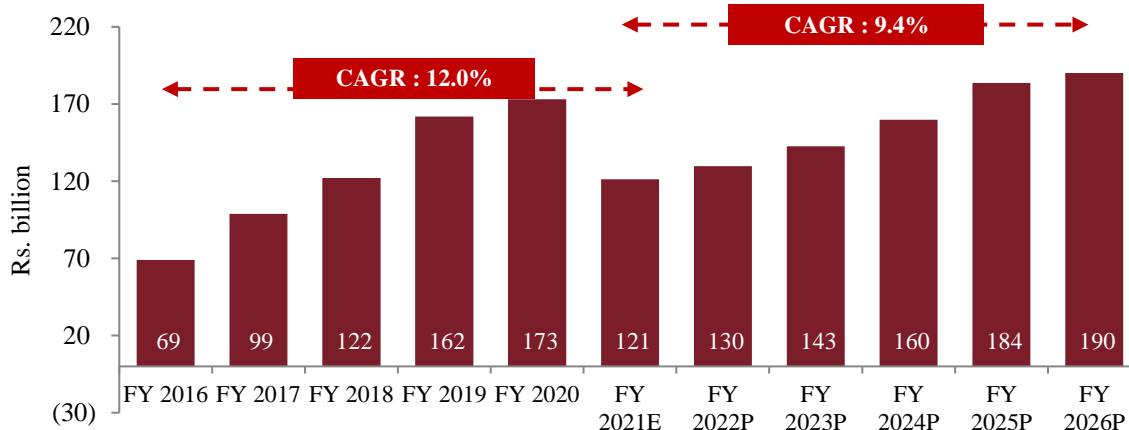

Note: P – Projected
Source: CRISIL Research

Precision engineering in power industry

Components such as hydro turbines, pumps, valves and motors are precision engineered in power generation, transmission and distribution. High precision components are used to obtain high efficiency of power output, avoid leakages and sustain in various weather conditions.

Generation, transmission and distribution of power occur at very high voltages and require precision engineering to avoid leakages. Transmission towers need precision components to withstand extreme weather conditions.

Precision engineering in other sectors

Precision engineering is used across industries like railways, in electric as well as diesel locomotives, mainly while manufacturing engine components. It is a similar case with construction equipment and tractors. Medical equipment, which is fitted within the human body, are also precision engineered.

Export trade scenario

Exports have 19-20% share in the precision engineering industry

Exports contributed 19-20% of precision engineering turnover in Fiscal 2021. Exports have been growing on par with the domestic industry demand for precision engineering products as players have made huge investments in India for manufacturing.

Share of export and domestic sales in precision engineering industry

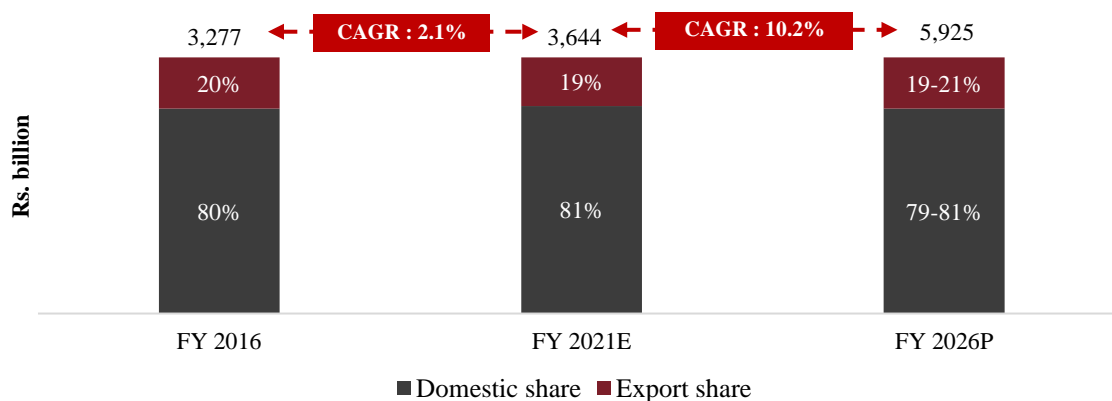

Note: P – Projected

Source: CRISIL Research

Competition scenario

CRISIL Research has compared key players in the precision engineering and components industry across sectors, such as automotive components, defence, engineering and capital goods, aircraft, power and others. The data has been obtained from publicly available sources, including annual reports and investor presentations of listed players, regulatory filings, rating rationales and/or company websites.

Player presence across industries

Company	Automotive	Defence	Engineering & capital goods	Aircraft	Power	Others
Aequis				✓		✓
Alpha Design Technologies		✓				
CIM Tools		✓		✓		
Dynamic technologies	✓	✓	✓	✓		✓
Godrej & Boyce		✓	✓	✓	✓	
L&T		✓			✓	✓
Mahindra Defence Systems		✓				
MTAR Technologies		✓			✓	
PMI Engineering Exports		✓		✓		
Sansera Engineering	✓		✓	✓		✓
Schaeffler India	✓					
Shanti Gears	✓				✓	✓
Sika Interplant Systems	✓	✓				
SKF India	✓		✓	✓	✓	✓
Timken India	✓	✓	✓	✓	✓	✓
Vem Technologies		✓				

Source: Company websites, CRISIL Research

MARKET SIZING AND OUTLOOK OF RELEVANT AUTO COMPONENT SEGMENTS

(The following has been sourced from pages 189 to 192 of the CRISIL Report).

Introduction

Automotive components like connecting rods, crankshafts, rocker arms and gear shifter forks are manufactured using complex engineering processes. These precision components are manufactured using complex engineering processes, and given how critical they are to automotive systems, they require a high level of precision and adherence to high standards of quality. This requires close coordination between component manufacturers and OEMs throughout the product cycle, from design to testing and validation to delivery. Manufacturing of engine components is capital and technology intensive in nature. Delivering these components with exact specifications is very critical. The machines needed to manufacture these components are very costly and generally imported by the players. Therefore, companies that have the ability to manufacture these machines in-house have a competitive edge over their peers.

OEMs used to outsource forged components whereas machining operations were performed in-house. As OEMs focus on their resources on the final assembly of vehicles, they are increasingly looking to external suppliers for content that they have previously produced in-house. With improved capabilities and confidence of suppliers, OEMs have now gradually started outsourcing entire forging and machining operations of these components. This trend is underpinned by OEMs' growth outside their home markets, consumer expectations with regard to product complexity and feature integration and an increased focus on safety and the environment.

With tightening emission norms and further optimization of engine, established suppliers will be driven to deliver these components using new and high strength materials with close dimensional and weight tolerances as well as stringent cleanliness requirements. Quality suppliers are well positioned to benefit from such trends.

Connecting rods

A connecting rod is an important component of an ICE, used in converting the reciprocating motion of a piston into the rotary motion of a crankshaft, and vice versa. The rod connects the piston to a crank or crankshaft, with the smaller end connected to the piston and the bigger one to the crankshaft.

There are various types of connecting rods, such as integral, split and fractured-split (FS). The integral type finds its application primarily in one-cylinder engines that are used in two-wheelers. Here, the rod and the cap of the connecting rod cannot be separated. However, the higher-cc (generally more than 300 cc) engines in two-wheelers use an FS connecting rod. The majority of passenger vehicles also use the FS type. In commercial vehicles, small commercial vehicles (SCV) have a split type of connecting rod; however, at higher tonnage, FS connecting rod is used. Even in SCV, OEMs are shifting towards FS connecting rod. In tractors, industry is mainly dominated by FS connecting rod.

The number of connecting rods needed in an engine is directly proportional to the number of cylinders in an engine. Therefore, two-wheelers that generally have single-cylinder engines will have one connecting rod; it is a similar case with three-wheelers. While passenger vehicles typically have four-cylinder engines, they have four connecting rods. In commercial vehicles, the number of cylinders varies from 2-cylinder (in sub-one tone) till 6-cylinder engine (in higher tonnage truck or bus). Cylinder configuration in tractor varies from 1-cylinder (found in 15HP tractors) till 4-cylinder engine (found in higher powered tractors).

Connecting rods are typically manufactured by using forging and machining processes. The raw material used in manufacturing can vary depending on the weight and tensile strength required. Since the connecting rod is a moving part in an engine and is subject to wear and tear, its tensile strength is a key parameter for consideration in the designing process.

Led by BS-VI transition, most of the component players have started using superior quality raw materials along with higher carbon content in steel to make connecting rods with higher tensile strength.

Connecting rod market for various vehicle categories in India

Review, Fiscal 2021

CRISIL Research estimates the size of the connecting rod market (catering to OEM demand) to be Rs. 10.6 billion in Fiscal 2021.

The passenger vehicle segment contributes to a higher share in the connecting rod market, due to the higher per-unit cost and higher usage intensity per vehicle varying across micro-to-premium passenger vehicle segments. Intensity of connecting rod is higher in commercial vehicle as well, varying from 2-cylinder for small commercial vehicle to 6-cylinder for heavy commercial vehicle.

Connecting rod market split by vehicle category in value terms, Fiscal 2021

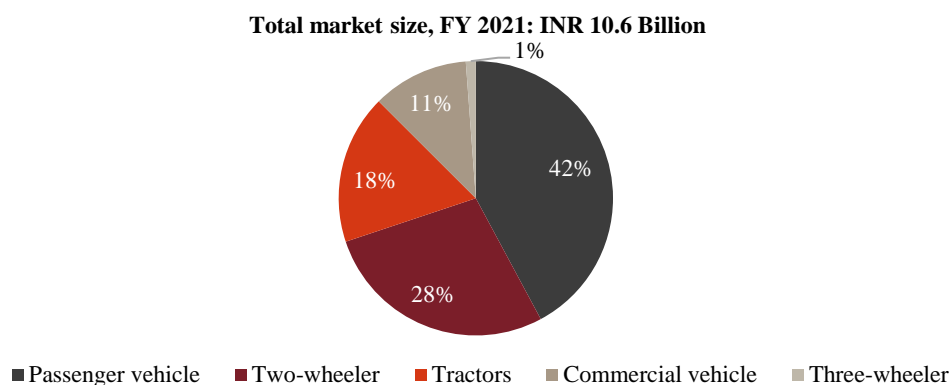

Source: SIAM, SMEV, CRISIL Research

Additionally, in the passenger vehicle segment, if connecting rod is supplied as part of the piston assembly (i.e., with piston and ring), then realisation for the component manufacturer could be 65 to 70% higher as compared to realisation per connecting rod.

Key Players

Amtek Auto, Amul Industries, Magal Tech and Sansera are the leading manufacturers of connecting rod for passenger vehicle OEMs in India. Other players in this space include Bajaj Motors, Fortuna Engineering, and SATA Vikas.

For the two-wheeler connecting rods, key manufacturers include Bajaj Motors, Musashi, and Sansera. Other players include FIE group, Highway Cycles, Kalyani Forge, Kay Jay Forge and Modern Automotive.

Sansera is the largest supplier of connecting rod to two-wheeler as well as to passenger vehicle OEMs in India.

Outlook, Fiscals 2021-2026

CRISIL Research estimates the size of connecting rod industry to grow at 11.8% CAGR to Rs. 18.5 billion between Fiscals 2021 and 2026.

Optimisation of the engine design is not expected to result in significant weight reduction for connecting rods. However, on the raw material front, the industry is expected to increasingly shift to steel alloys of precious metals, such as boron, vanadium and titanium to impart higher fatigue strength, lower inertia, among other parameters.

The shift towards cleaner energy fuel, mainly electric vehicles, will lead to the replacement of engine components by batteries and motors. CRISIL Research expects electrification in two-wheelers to be 6-8% by Fiscal 2026. CRISIL Research expects the sales of ICE scooters to be cannibalised by high-speed electric scooters. CRISIL Research does not expect a significant shift towards electric in motorcycle front in the next five years. In the passenger vehicle segment, the move towards hybrid vehicles along with pure electric vehicles is also catching up. The engine and engine components will continue to be required in case of a move towards hybrid vehicles. CRISIL Research expects electric penetration in passenger vehicle to be 3-5% and in light commercial vehicle (<7.5T) to the tune of 2% and 3% in buses by Fiscal 2026.

Connecting rod market outlook across vehicle segments (Rs. billion), Fiscals 2021 to 2026P

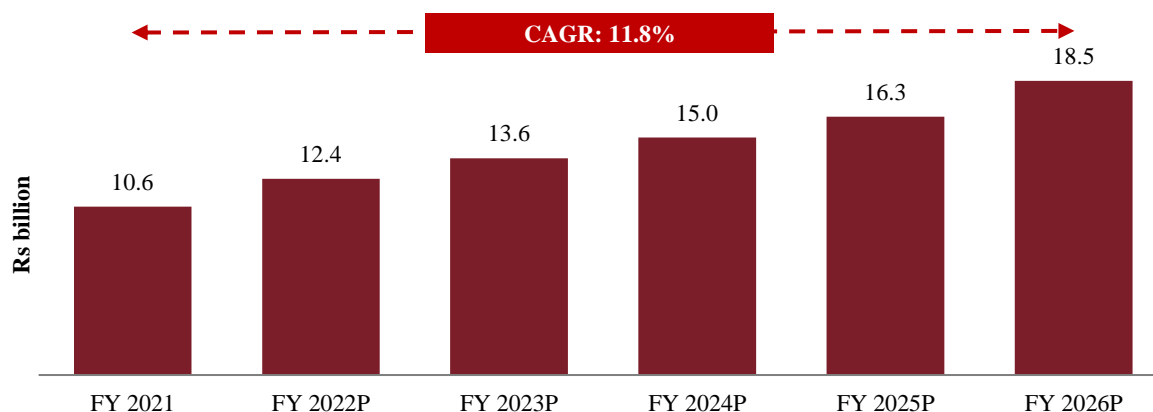

Note: P – Projected; connecting rod market size includes demand from passenger vehicle, two-wheeler, tractor, commercial vehicle and three-wheeler segments
Source: CRISIL Research

Connecting Rod Market Size in Light Vehicle Segment (Global)

(The following has been sourced from pages 30 to 43 of the Ricardo Report).

Global Engine Production in Light Vehicle Segment

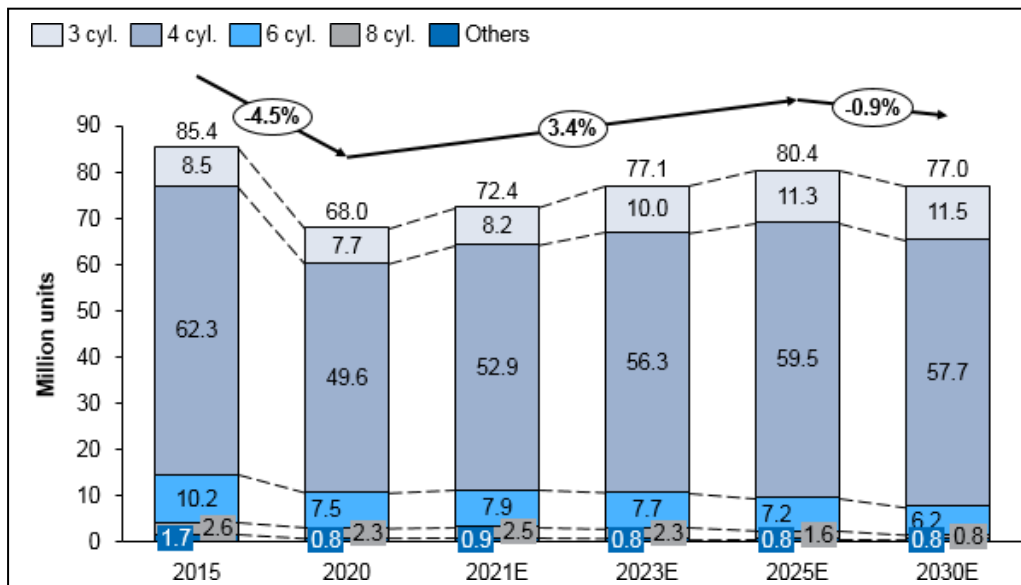

Source: Ricardo Analysis, Public Domain

The Light Vehicle engine market is likely to grow at approximately 3.4% CAGR between CY 2020-2025 and engine production is expected to drop post CY 2025 due to increase in the influx of BEVs. As of CY 2020, share of BEVs was approximately 3.3% and it is projected to increase to approximately 12.2% by CY 2025 and to approximately 23.4% by CY 2030. For the other propulsion types, engine downsizing is likely to continue as the technology matures and emission norms evolve. Hence, Ricardo expects the share of three and four cylinder engines to continue growing while six and eight cylinders will decline.

Global Connecting Rod market forecast for Light Vehicle Segment

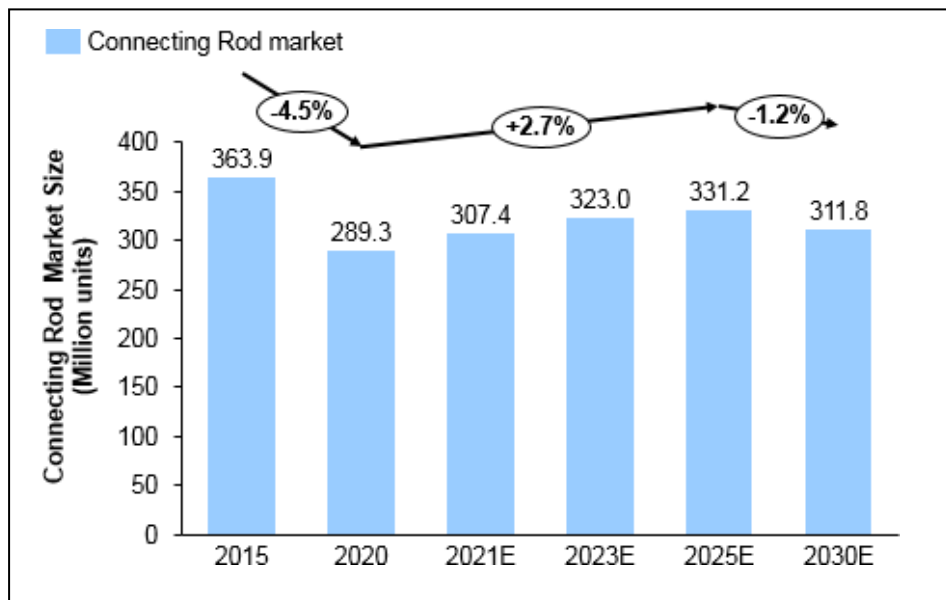

With a CAGR of approximately 2.7%, the Light Vehicle connecting rod market is expected to grow from approximately 289.3 million units in CY 2020 to approximately 331.2 million units in CY 2025 and decline post CY 2025 to reach approximately 311.8 million units by CY 2030.

Market Share of Sansera in Light Vehicle Segment

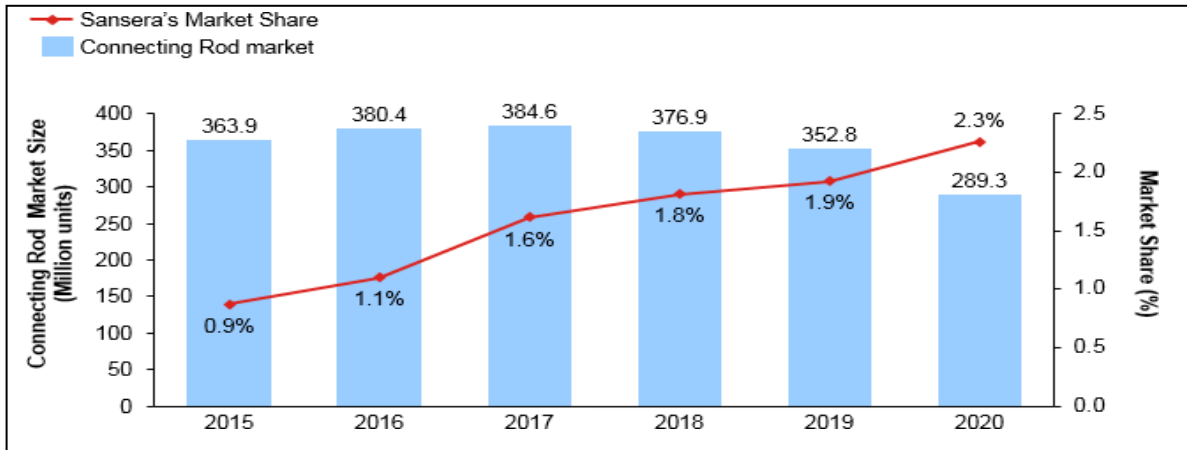

Source: Ricardo Analysis, Data provided by Sansera

Sansera has more than doubled its global market share in connecting rods in terms of production volume (units) during the past five years within the Light Vehicle Segment from approximately 0.9% in CY 2015 to approximately 2.3% in CY 2020.

Sansera supplies connecting rods to six out of the top 10 global Light Vehicle OEMs.

Supplier Market Share in Light Vehicle Segment

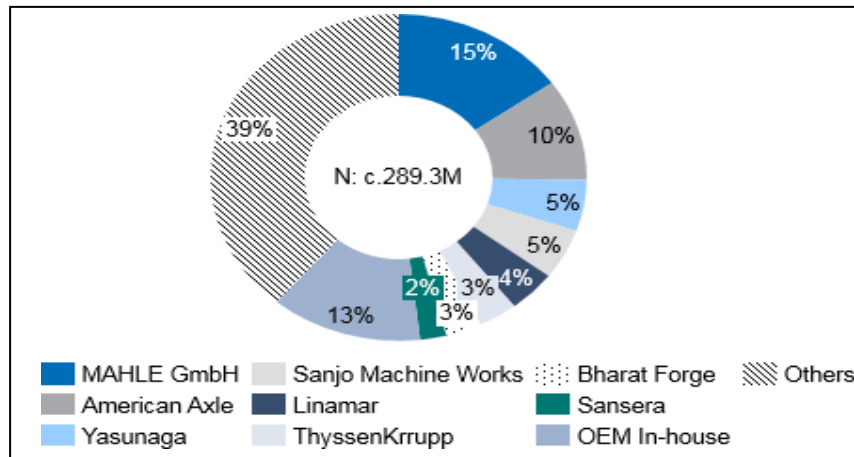

Source: Ricardo Analysis, Public Domain

Light Vehicle supplier market share is calculated based on production volumes in key regions such as Europe, China and the United States. The Light Vehicle connecting rod market is fragmented and approximately 60% of the market is divided amongst 10 companies, including OEM in-house. With approximately 2.3% market share, Sansera is one of the top 10 suppliers of connecting rods in the Light Vehicle Segment.

Connecting Rod Market Size in Commercial Vehicle Segment (Global)

Global Engine Production in Commercial Vehicle Segment

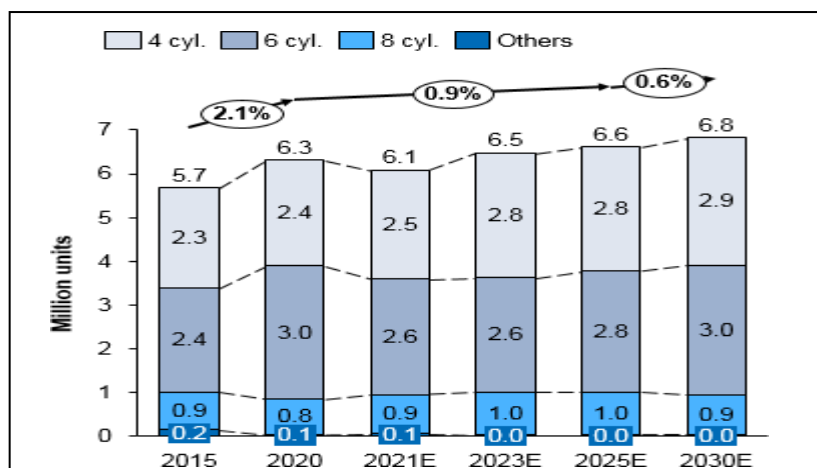

Source: Ricardo Analysis, Public Domain

By CY 2030, the CV engine market is expected to reach approximately 6.8 million units. With increased focus on improving FE and stringent emission norms, downsizing trends will continue. OEMs are likely to downsize 6-cylinder engines with 4-cylinder engines. Pure BEV for intracity and FCEVs for long haul are being introduced by leading CV OEMs (Volvo, Scania, Daimler etc.) resulting in gradual electrification of approximately 9% by CY 2030. Electrification will be seen via both pure BEVs as well as FCEVs.

Global Connecting Rod Market Forecast for Commercial Vehicle Segment

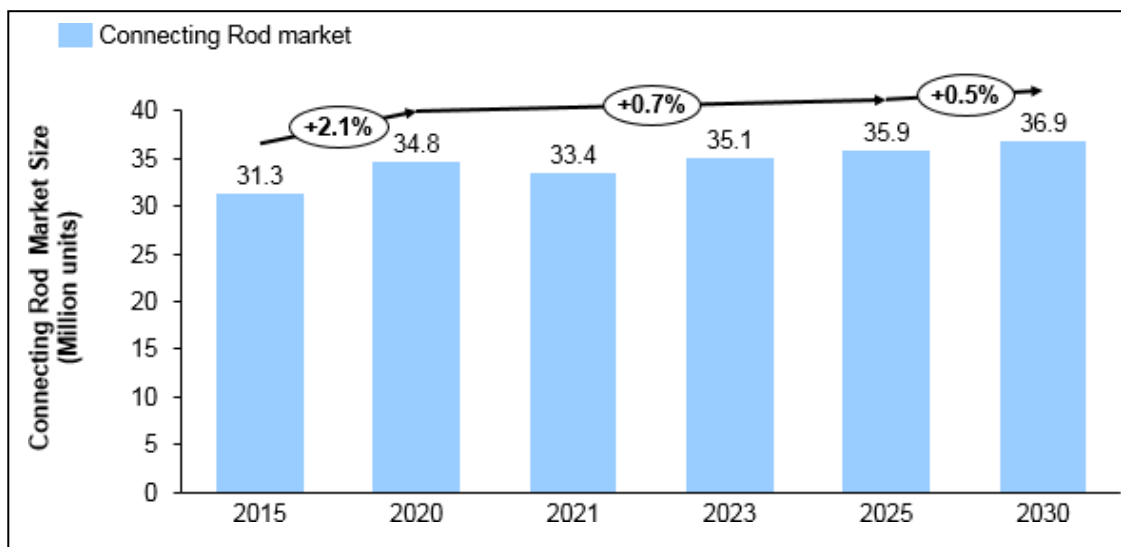

Source: Ricardo Analysis, Public Domain

Connecting Rod market size in CV segment was approximately 34.8 million in CY 2020 will grow at a CAGR of 0.7% to approximately 35.9 million by 2025 and then at a CAGR of 0.5% to reach approximately 36.9 million by CY 2030.

Market Share of Sansera in Commercial Vehicle Segment

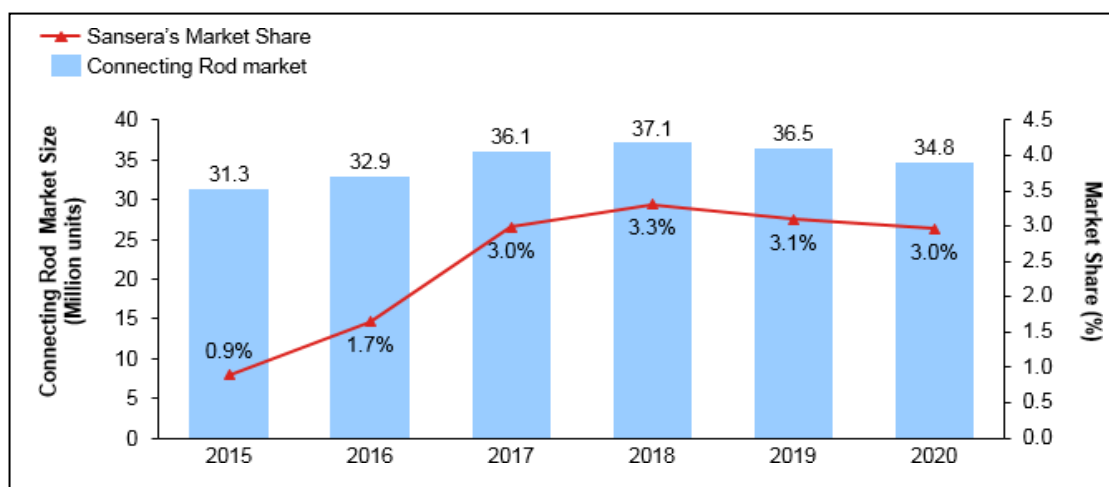

Source: Ricardo Analysis; data provided by Sansera

Sansera has gained significant global market share in connecting rods based on production volume (units) in the CV segment from approximately 0.9% in CY 2015 to approximately 3.0% in CY 2020. The jump in market share was evident in 2017 post acquisition of Mape Sweden AB (now known as Sansera Sweden AB, “Sansera Sweden”).

Sansera is a supplier to three out of the top 10 global MHCV OEMs.

Supplier Market Share in Commercial Vehicle Segment



Source: Ricardo Analysis, Public Domain

Commercial Vehicle supplier market share is calculated based on the production volumes in key regions such as Europe, China, USA, etc., approximately 50% of the Commercial Vehicle connecting rod market is concentrated among the top five companies, including MAHLE GmbH, American Axle. With approximately 2.9% market share, Sansera is one of the top 10 suppliers in the CV segment.

Global Connecting Rod Market Size (Cumulative) – by Volume

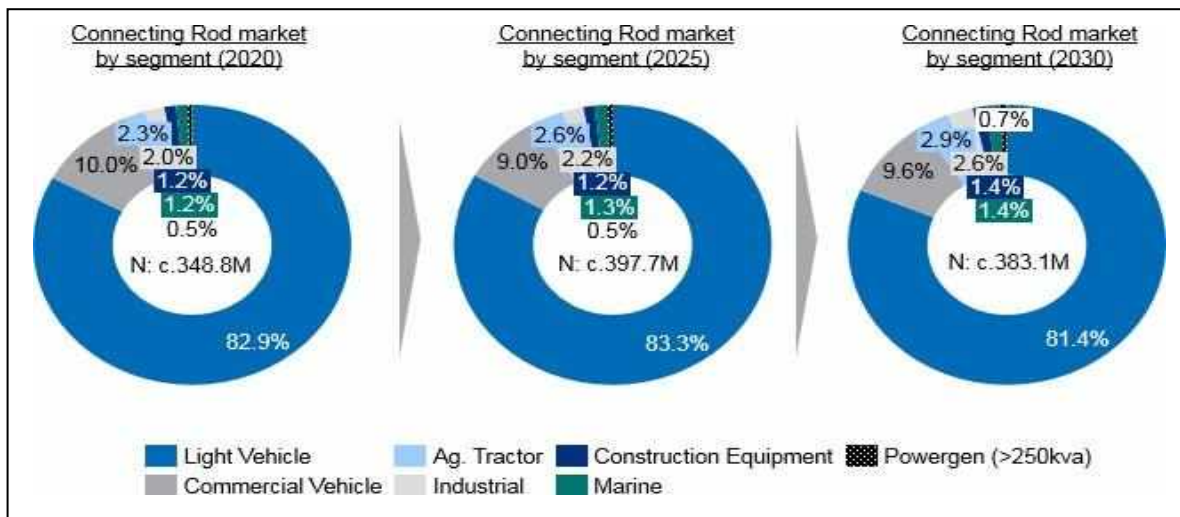

Source: Ricardo Analysis, Public Domain

Global Connecting Rod Market Size (Cumulative) – by Value

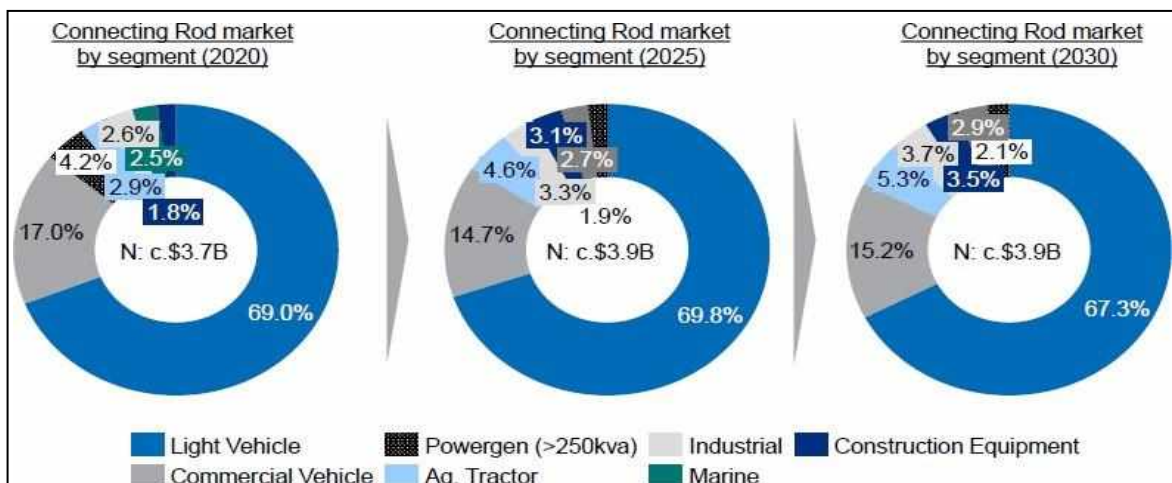

Source: Ricardo Analysis, Public Domain

In spite of the growing electrification trend in the Light Vehicle segment, the global market value of connecting rods will remain

significant at USD \$3.9 billion by CY 2030.

Sansera is a leading supplier in the Light Vehicle and CV segments. Sansera also supplies to other segments such as tractors, CE, industrial, marine and stationary engines. The total volume of connecting rods supplied by Sansera for CY 2020 was 7.6 million units, which represented approximately 2.2% of the overall connecting rod market by volume (units).

Size of Connecting Rod Market in Automotive/Non-Automotive Segments

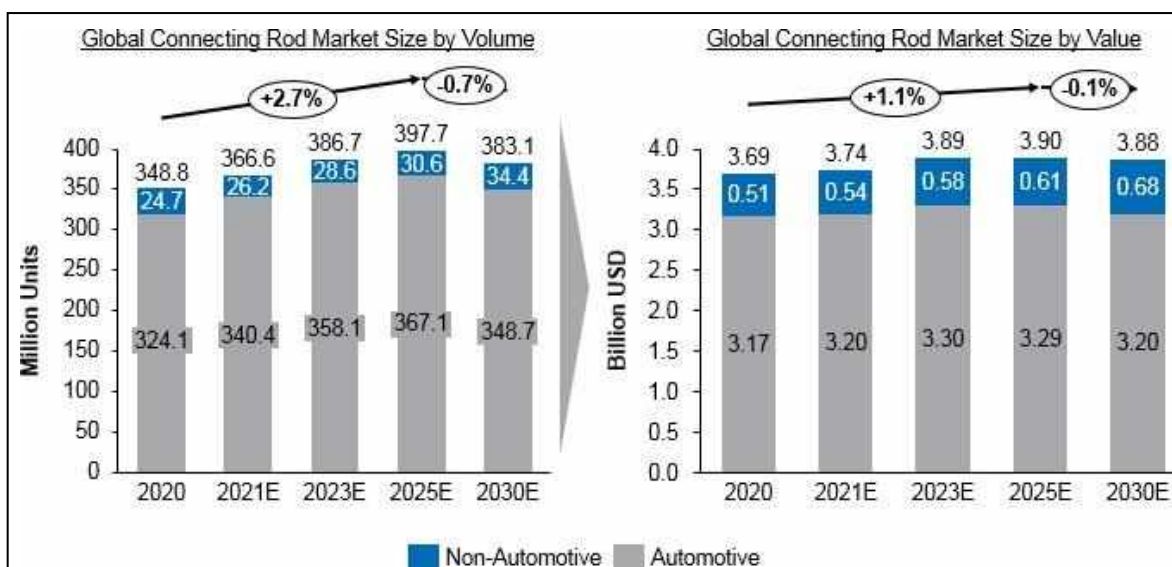

Source: Ricardo Analysis, Public Domain

Note: Non-Automotive includes the following segments: Ag Tractors, Industrial, Construction Equipment, Marine and Powergen; Automotive: Light Vehicle and Commercial Vehicle segments

Global connecting rod market volume and value are likely to grow by a CAGR of approximately 2.7% and approximately 1.1%, between CY 2020-25, respectively. Post CY 2025, volumes are projected to decline because of electrification in the Light Vehicle market. In terms of value, the decline is marginal as the non-automotive segments compensate for the decreased value in automotive segments.

Comparison of Financial Information – Global Players

Company	Revenue (\$ million)		
	2020	2019	2018
Sansera	220.1	206.2	229.7
MAHLE GmbH	11,728.8	14,458.8	15,097.2
American Axle	4,710.8	6,530.0	7,270.4
Yasunaga	315.4	350.0	322.7
Linamar	4,728.1	6,029.8	6,195.6
ThyssenKrupp	34,678.8	40,843.2	41,732.4
Bharat Forge	1,154.1	1,448.8	1,170.1

Ratios	Sansera			Industry		
	2020	2019	2018	2020	2019	2018
EBITDA Margin	18.8%	16.3%	18.5%	12.4%	10.6%	12.5%
PAT Margin	7.0%	5.4%	6.1%	-3.1%	1.1%	3.8%
ROE	12.4%	10.3%	14.2%	-35.7%	-11.2%	7.9%
ROCE	15.1%	12.9%	22.4%	2%	8.5%	12%
Net Debt to Equity	0.5	0.7	0.8	2	1.2	0.9
Net Debt to EBITDA	1.6	2.3	1.9	3.1	0.6	2.4

Source: Ricardo Analysis, Public Domain

Calculation of Financial Ratios:

- EBITDA Margin: EBITDA / Revenue
- PAT Margin: PAT / Revenue
- ROE: PAT / Net Equity
- ROCE: EBIT / (Total Assets - Current Liabilities)
- Net Debt to Equity: Net Debt / Total Equity
- Net Debt to EBITDA: Net Debt / EBITDA
- Net Debt: Short term borrowings + Long term borrowings - Cash & cash equivalents

The companies mentioned are key global connecting rod suppliers for light and commercial vehicle segments. Financial information is considered based on each company's past three financial years. For instance, 2020 is the period from April 1, 2020 to March 31, 2021 for Sansera while for ThyssenKrupp, it is the period from October 1, 2019 to September 30, 2020.

Sansera has delivered consistent PAT margins and ROE during the 2018-2020 period. Efficient management of operations has helped Sansera to report consistently higher EBITDA margins than its peers. Effective use of capital has ensured a 12.9-22.4% RoCE for Sansera over the 2018-2020 period. Sansera has maintained a gearing ratio (Net debt/Equity) of 0.5-0.8, as compared to industry gearing ratios of >0.85 over the last three years. Highly leveraged competitors (e.g., ThyssenKrupp and American Axle) are the main reason for the high industry gearing ratios.

Crankshafts

(The following has been sourced from pages 193 to 208 of the CRISIL Report).

The crankshaft is a critical part in engine assembly, which is connected to the pistons on one side and flywheel on the other. A crankshaft converts reciprocating motion of the pistons into rotational motion for the flywheel. The flywheel is, in turn, connected to the axles to put the vehicle in motion.

Crankshafts are available in two configurations: integral (single piece) and built-up. Integral crankshafts find their application mainly in passenger vehicles while built-up crankshafts are primarily used in single cylinder engines of two-wheelers with less than 300 cc capacity. Two-wheelers with engines higher than 300 cc typically use integral crankshafts. Every two-wheeler and passenger vehicle has one crankshaft. Integral crankshafts are preferred over built-up ones for higher cc engines because of their ability to reduce vibrations and control balancing – issues that built-up crankshafts face. Crankshafts for two-wheeler and passenger vehicles are usually manufactured by using either a casting or forging process followed by machining. However, the possibility of breakage is higher with casted crankshafts. Therefore, these are used in lower capacity engines only. Hence, most OEMs prefer forged crankshafts. Generally, alloy steel is used for manufacturing crankshaft (alloy of steel with titanium, boron, vanadium, etc.) or carbon steel (iron with smaller percentage of carbon) for crankshafts of two-wheeler and passenger vehicles. Raw materials are carefully selected so that the crankshaft has specific properties such as higher tensile strength, more fatigue life and higher corrosion resistive property.

Two-wheeler and passenger vehicle crankshaft market in India

Review, Fiscal 2021

CRISIL Research expects the size of the two-wheeler and passenger vehicle crankshaft market in India catering to original equipment manufacturers (OEMs) at Rs. approximately 17.2 billion in Fiscal 2021.

Crankshafts market split by vehicle categories in value terms, Fiscal 2021

Market size of FY 2021: INR 17.2 Billion

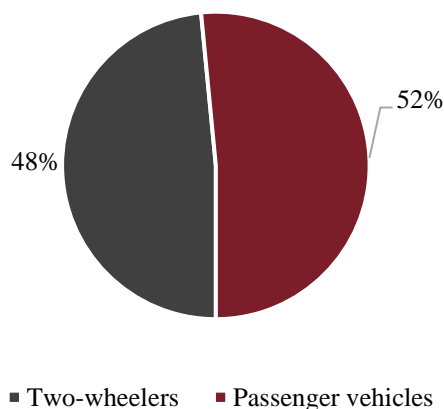

Source: SIAM, SMEV, CRISIL Research

If the crankshaft is supplied as an assembly to two-wheeler OEMs, then the supplier realisation will be 30-40% higher over bare crankshaft halves. The higher realisation is on account of bought out parts such as crank pin, bearings and sprockets.

Key Players

Kay Jay Forge, Laxmi-Agni and Sansera are the leading manufacturers of two-wheeler crankshafts in India. Other players in this space include Amtek Auto, Highway Cycles, Kalyani Forge and Modern Automotive.

Amtek Auto, Bharat Forge and Mahindra CIE are key manufacturers of passenger vehicle crankshafts.

Outlook, Fiscals 2021 to 2026P

CRISIL Research estimates the two-wheeler and passenger vehicle crankshaft market to clock 13.2% CAGR to Rs. 32.0 billion by Fiscal 2026. Demand for crankshaft in value terms is expected to grow faster than underlying volume growth across vehicle

segments on account increase in demand for premium vehicles in both two wheelers and passenger vehicles where realisation for component manufacturer is higher. Even cost escalations are also expected to support higher value growth.

Going forward, due to CAFE norms, CRISIL Research expects few changes either on weight or the type of raw material used to manufacture crankshafts. However, CRISIL Research does not expect any major change in the cost of the crankshaft. Hybrid vehicle will be a combination of ICE and electric. Here, the crankshaft size is expected to undergo minor changes depending on the engine design.

Outlook for two-wheeler, passenger vehicle crankshafts market (Rs. billion), Fiscals 2021 to 2026P

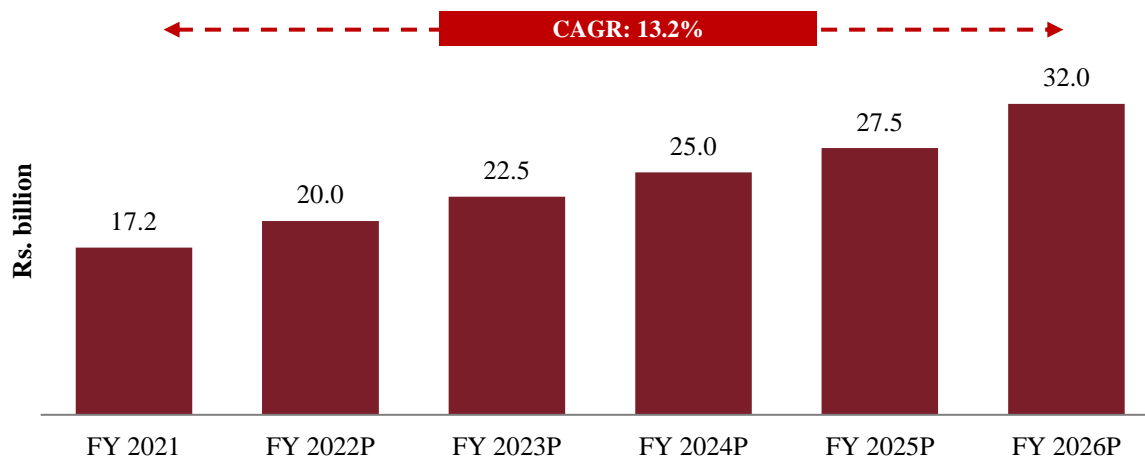

Note: P – Projected
Source: CRISIL Research

Rocker arms

The rocker arm is an important part of the valve train in the fuel injection system. It is a reciprocating lever, which converts the radial movement of the overhead camshaft into a linear movement that opens and closes the valves.

For two-wheelers, the intensity of the rocker arm is two per vehicle for a single cylinder engine with one inlet and one outlet valve. A passenger vehicle with four-cylinder engines having two inlet and outlet valves each for one cylinder uses 16 rocker arms.

The rocker arm is in continuous contact with the valve, which produces a lot of friction. Therefore, the raw material used is carefully selected so that the noise produced by the engine is reduced, weight of the rocker arm is less (less weight helps in reducing friction and gives higher rotations per minute (RPM)) and it has higher strength for higher operating efficiency.

Over the past 5-10 years, the industry has shifted from rocker arms to hydraulic lash adjusters (HLAs) and thimble tappets, particularly in the passenger vehicles segment. While the penetration of rocker arms in the passenger vehicles segment is currently at approximately 10%, the remainder is split between HLA and thimble tappets. However, the majority of the two-wheeler vehicles (approximately 90%) uses rocker arm whereas premium motorcycle uses DLC-coated rocker arms. As CRISIL Research expects to see a shift in trend towards premiumisation, the usage of DLC is likely to increase.

Two-wheeler and passenger vehicle rocker arms market in India

Review, Fiscal 2021

CRISIL Research expects the two-wheeler and passenger vehicle rocker arm market catering to OEM demand at Rs. 5.4 billion in Fiscal 2021.

For higher-end motorcycles, where DLC rocker arms are used, the average realisation is about 2-2.5 times higher versus basic rocker arms.

Two-wheelers enjoy a higher share of the rocker arm industry due to their higher volumes versus passenger vehicles.

Rocker arms market split by vehicle categories in value terms, Fiscal 2021

Total market size, FY 2021: INR 5.4 Billion

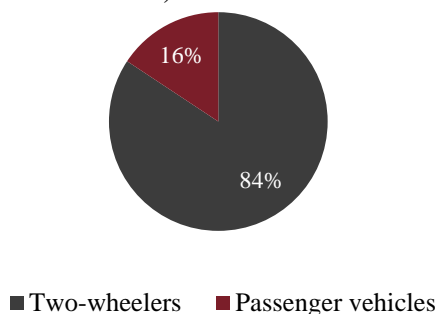

Source: SIAM, SMEV, CRISIL Research

Key Players

In India, Bajaj Motors, FIE group and Sansera, are among the leading two-wheeler rocker arm manufacturers in India.

Micro Turner, Sansera and Schaeffler India are the leading passenger vehicle rocker arm manufacturers in India.

Sansera is the largest supplier of rocker arms to two-wheeler as well as passenger vehicle OEMs in India.

Outlook, Fiscals 2021 to 2026P

CRISIL Research estimates the two-wheeler and passenger vehicle rocker arm market to clock 10.2% CAGR to Rs. 8.7 billion by Fiscal 2026.

The DLC rocker arm is expected to gain prominence as it is lighter in weight and creates less noise as compared to a rocker arm without DLC. While it is currently available only in high-end motorcycles due to its higher cost, going forward, the cost of DLC rocker arm is expected to come down on economies of scale.

Two-wheeler and passenger vehicle rocker arm market outlook (Rs. billion), Fiscals 2021 to 2026P

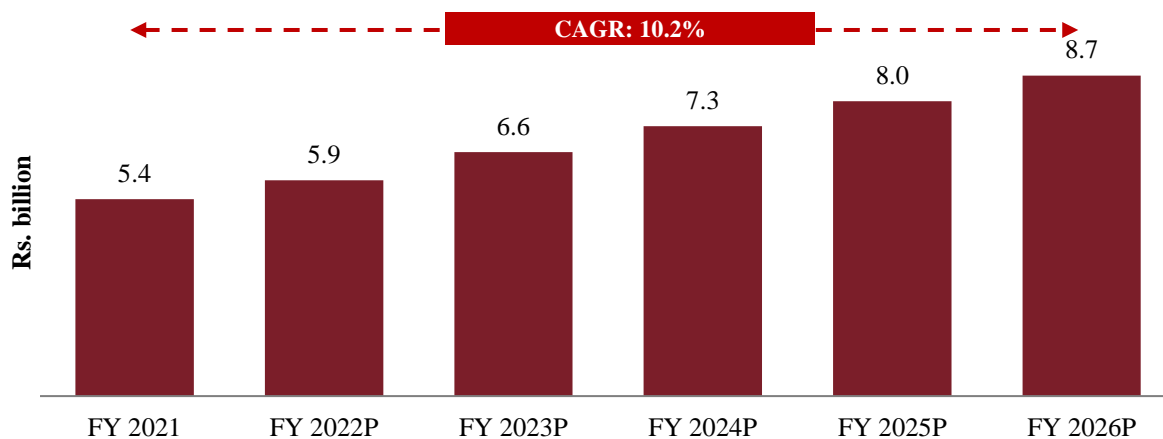

Note: P – Projected

Source: CRISIL Research

Gear shifter forks

A gear shifter fork is used to slide gears into or out of engagement with other gears to change from one gear ratio to another in a manual transmission. Only vehicles with manual transmission (including automated manual transmission (AMT)) have gear shifter forks.

In two-wheelers, most scooters and mopeds come with continuously variable transmission (“CVT”). However, the penetration of CVT is very low in passenger vehicles (at up to 1%), mainly due to higher cost of CVT vehicles compared with manual transmission vehicles.

The usage intensity of gear shifter forks depends on the number of gears in a vehicle. Most passenger vehicles have six forward and one reverse gears, resulting in a need for five gear shifter forks. In the case of two-wheeler motorcycles, two gear shifter forks are required, as a typical motorcycle has four forward gears. In the case of higher engine capacity motorcycles, generally three gear shifter forks (five forward gears) are required.

Gear shifter forks for passenger vehicles are typically manufactured by using processes, such as aluminium die-casting, forging, stamping and fine blanking. Forged gear shifter forks have higher durability versus investment casted gear shifter forks.

The raw material and process are selected based on the gear shifter fork’s specific properties, such as higher strength and stiffness. There is an increasing shift towards usage of aluminium in gear shifter forks in an attempt to lighter the vehicle weight.

Market for two-wheeler and passenger vehicle gear shifter forks in India

Review, Fiscal 2021

CRISIL Research expects the two-wheeler and passenger vehicle gear shifter fork market to have catered to an OEM demand of Rs. 3.1 billion in Fiscal 2021.

Gear shifter forks market split by vehicle categories in value terms, Fiscal 2021

Total market size, FY 2021: INR 3.1 Billion

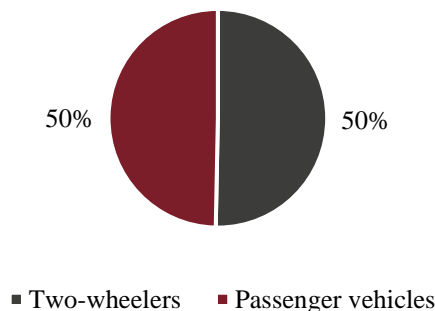

Source: SIAM, SMEV, CRISIL Research

Key players

Bajaj Motors, FIE Group and Sansera are the leading manufacturers of two-wheeler gear shifter forks in India. Sansera is the largest supplier of gear shifter fork to two-wheeler OEMs in India.

Kalyani Forge, Micro Turner, RICO Auto and Sansera are the leading manufacturers of passenger vehicle gear shifter forks in India.

Outlook, Fiscals 2021 to 2026P

CRISIL Research estimates the size of the two-wheeler and passenger vehicle gear shifter fork market to grow at 12.8% CAGR to Rs. 5.6 billion by Fiscal 2026.

CRISIL Research expects the penetration of CVT in passenger vehicles to remain less than 5% by Fiscal 2026. Even the penetration of EVs in the passenger vehicle space is expected to be 3-5% by Fiscal 2026. As a result, the impact of a change in transmission technology or electrification on gear shifter forks is projected to be limited by Fiscal 2026. In two-wheeler segment, penetration of EVs is expected to be 6-8% by Fiscal 2026 where the electrification will be largely led by scooters. CRISIL Research believes electrification in motorcycles may not pick up substantially due to higher cost of ownership. Therefore, electrification in two wheelers is not likely significantly impact the market for gear shifter forks.

Two-wheeler and passenger vehicle gear shifter fork market outlook (Rs. billion), Fiscals 2021 to 2026P

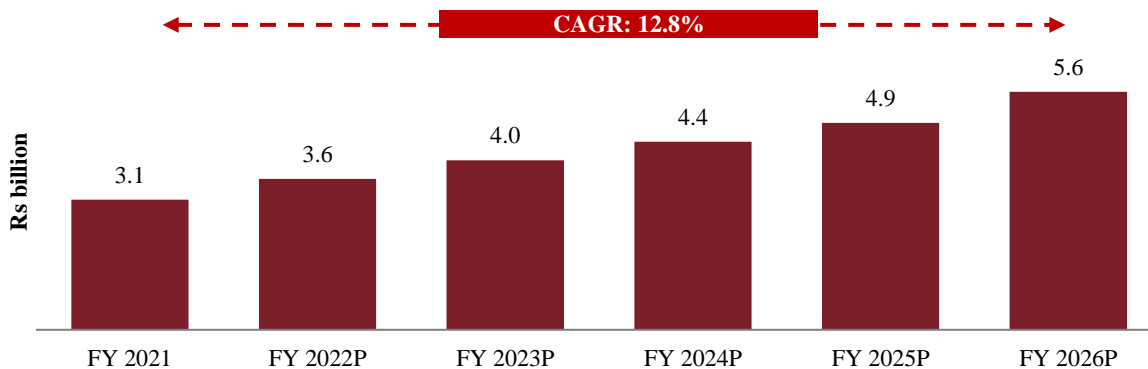

Note: P – Projected
Source: CRISIL Research

Stem comps for two-wheelers

Introduction



A stem comp is an intermediate part of the front-fork assembly in a two-wheeler. It connects with the handle bar at the top of the assembly and mates with suspension guides in the lower part of the assembly. It is usually made up of two parts, namely a bracket and a stem, which are welded together.

Primarily, the role of the component is to withstand torsional stress and to ensure seamless manoeuvrability of the front wheel.

Two-wheeler stem comp market in India

Review, Fiscal 2021

CRISIL Research estimates the size of the two-wheeler stem comp market (catering to OEM demand) to have been Rs. 7.5 billion in Fiscal 2021.

Total market size, FY21: INR 7.5 billion

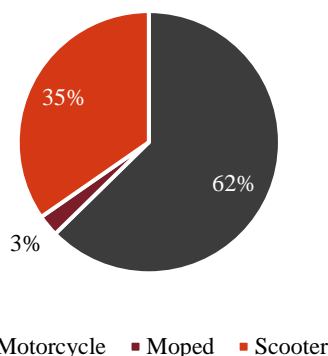

Source: SIAM, CRISIL Research

Demand for stem comp in scooters increased over the last few years as one of the major OEMs in the scooter segment shifted from a forged steel fork configuration to stem comp configuration. Demand for stem comp also increased due to regulatory requirements such as safety and crash test norms which command a higher strength. In addition, scooter stem comps command better price realisation than motorcycles in economy and executive segments.

Key players

Key suppliers for stem comps include Bajaj Motors, Endurance Technologies, Modern Automotives and Sansera.

Outlook, Fiscals 2021-2026

CRISIL Research estimates the two-wheeler stem comp market to grow at 13.8% CAGR to Rs. 14.3 billion, between Fiscals 2021 and 2026. Demand for this component will not be adversely impacted by electrification since it is technology agnostic.

Growth in the stem comp market is attributed to the following:

- Expected growth in contribution from the scooter segment in total production from 24.8% in Fiscal 2021 to 31.9% in Fiscal 2026.
- Higher price realisation in the scooter segment, almost 1.3 times compared with the overall motorcycles segment, is expected to result in the share of scooters in value terms to increase to 42.7% in Fiscal 2026 from 34.7% in Fiscal 2021.
- Expected increase in share of premium motorcycles in overall motorcycles from 16.1% in Fiscal 2021 to 20.2% in Fiscal 2026.
- Change in some scooter models, which still use fork configurator for suspension mounting, to stem comp-based configuration.
- Increased usage of aluminium in stem comp in premium bike segments for light-weighting avenues.

Two-wheeler stem comp market outlook (Rs. billion), Fiscal 2021 to Fiscal 2026

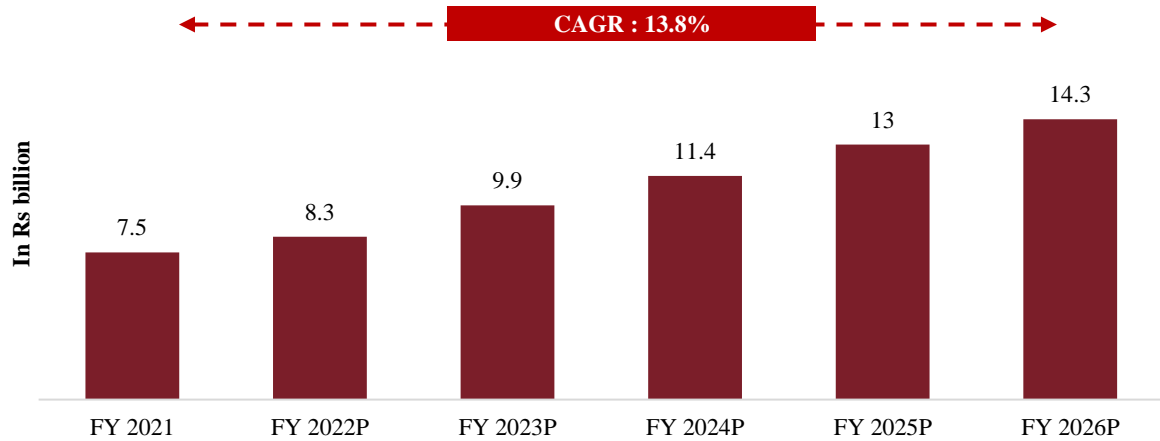

Note: E – Estimated; P – Projected
Source: SIAM, CRISIL Research

Two-wheeler Axle

Introduction



An axle is used as a mounting point to integrate the wheel with the steering assembly on the front side of a two-wheeler. On the rear side, an axle is used to integrate the wheel with the prime mover or hub of the vehicle. Axles are used in motorcycles, scooters as well as mopeds. Each two-wheeler (including electric two-wheelers) comes with a pair of axles – a front and rear axle.

Two-wheeler axle market in India

Review, Fiscal 2021

CRISIL Research estimates the size of the two-wheeler axle market (catering to OEM demand) to have been Rs. 2.7 billion in Fiscal 2021.

Total market size, FY 2021: INR 2.7 Billion

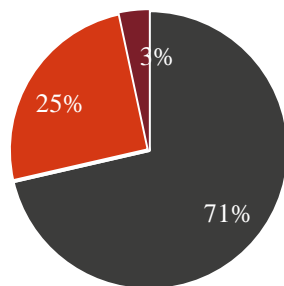

■ Motorcycle ■ Scooter ■ Mopeds

Source: SIAM, CRISIL Research

CRISIL Research estimates the two-wheeler axle market will grow at 13.5% CAGR to Rs. 5.1 billion between Fiscals 2021 and 2026. Growth in the axle market will be driven by robust demand for two-wheeler, shift towards premium scooters and motorcycles where the average realisation of a pair of axles is higher.

Two-wheeler axle market outlook (Rs. billion), Fiscal 2021 to Fiscal 2026

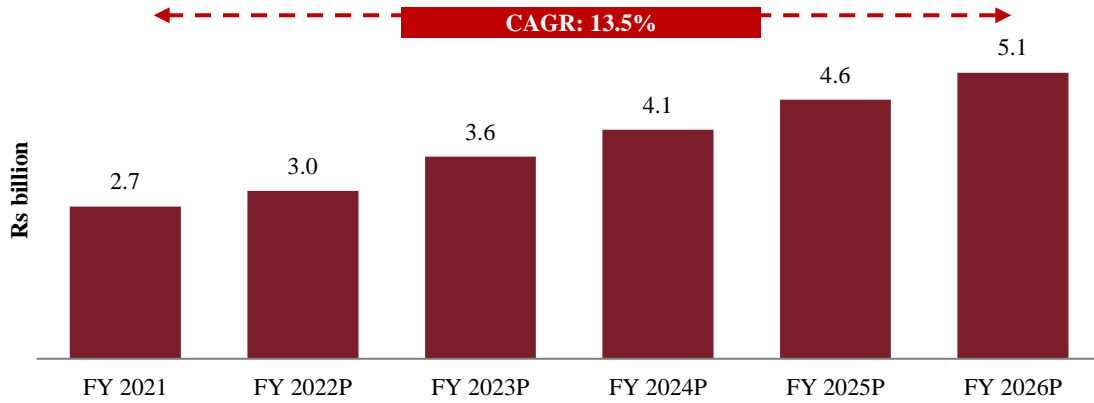

Note: P – Projected
Source: SIAM, CRISIL Research

Market Size of Drive Train Components for Hybrid Transmission Systems (Global)

(The following has been sourced from pages 46 to 49 of the Ricardo Report)



Source: Ricardo Analysis, Data provided by Sansera

Motor generator shaft can potentially be used in several hybrid / BEV architectures including those in which a dedicated transmission has not been provided for the hybrid. Rest of the parts (pictured above) can be used in hybrid architectures that feature dedicated hybrid transmission.

Size of Drive Train Components for Hybrid Transmission Systems in Global Light Vehicle Market – by Volume

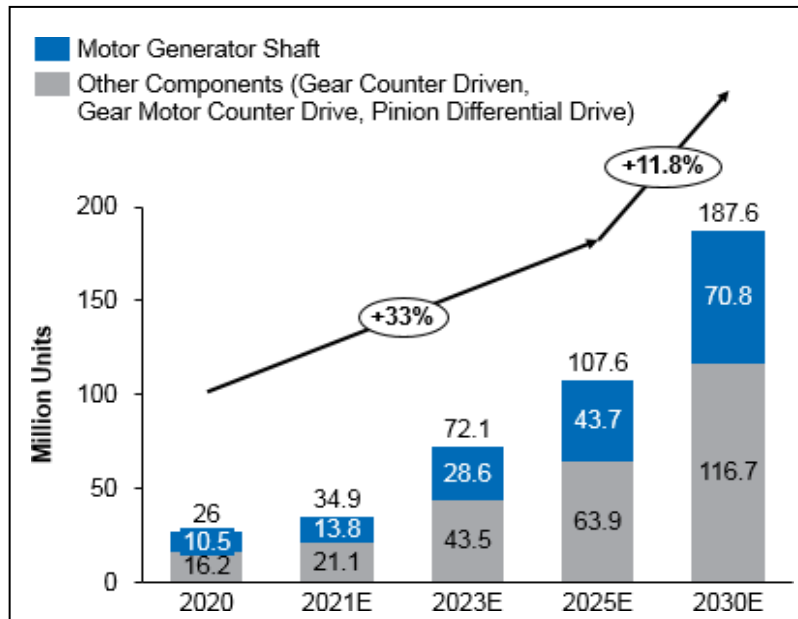

Source: Ricardo Analysis, Public Domain

The market size of hybrid transmission parts is expected to increase from approximately 26 million units to approximately 107.6 million units during CY 2020-2025.

Size of Drive Train Components for Hybrid Transmission Systems in Global Light Vehicle Market – by Value

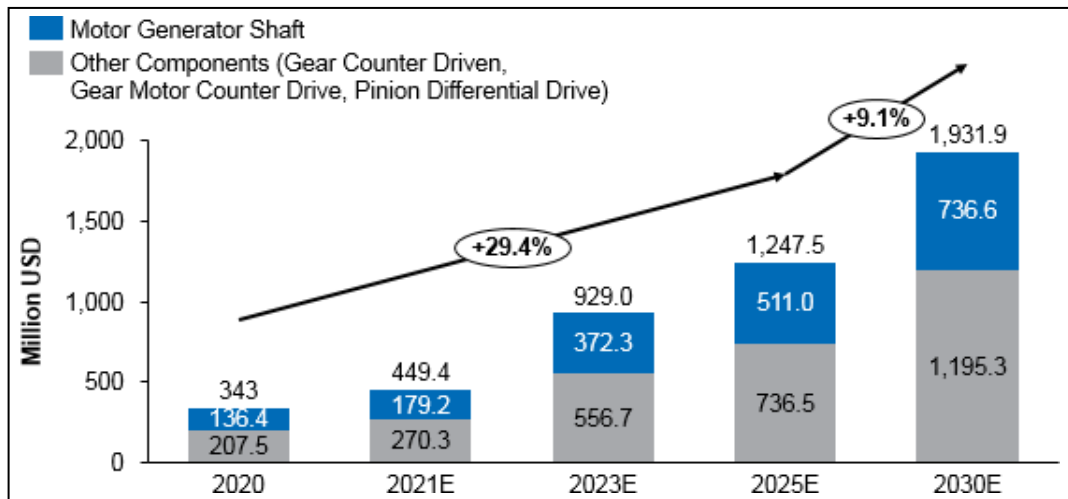

Source: Ricardo Analysis, Public Domain

The market value of hybrid components are expected to increase from approximately US\$343 million to approximately US\$1,247.5 million between CY 2020-2025, representing a CAGR of approximately 29.4% over the five years to CY 2025. Unit prices are expected to drop as volume increases. Current prices are assumed for supplier average production volumes of approximately 20,000 per annum and the prices are likely to drop as the economies of scale improve; approximately 10% drop in prices assumed for CY 2025 and approximately 20% by CY 2030. The mentioned prices are considering manufacturing in regions such as China, EU, etc.

COMPARISON OF FINANCIAL INFORMATION – INDIAN PLAYERS

(The following has been sourced from pages 209 and 210 of the CRISIL Report)

Profitability ratios: Summary for key auto components players

Companies/ Particulars	Operating Income (Rs mn)		Operatin g EBITDA (Rs mn)	PBT (Rs mn)	PAT (Rs mn)	Operatin g EBITDA margin (%)	PAT margin (%)	ROC E (%)	ROE (%)	Gearin g ratio	Debt to EBITD A
	FY20	CAGR FY16- 20									
Connecting rod											
Sansera Engineering	12,657	10.9%	2,253	905	823	17.8	6.5	10.4	11.1	0.8	2.7
Amtek Auto [^]	11,431	-7.0%	469	-3,566	-3,566	4.1	-31.2	-17.2	0.0	-1.2	240.5
Musashi	9,770	N.A	1,182	156	98	12.1	1.0	4.2	1.3	0.0	0.0
Bajaj Motors	6,113	2.1%	813	565	471	13.3	7.7	16.1	16.1	0.3	1.2
Kay jay Forge [^]	5,150	19.7%	355	92	57	6.9	1.1	11.0	7.9	1.7	3.5
Amul Ind [^]	2,767	11.1%	113	-107	-108	4.1	-3.9	3.2	-28.3	3.0	8.6
Modern Automotive	2,324	17.3%	256	102	53	11.0	2.3	17.2	13.3	1.6	2.7
Kalyani Forge	2,021	-3.1%	99	-81	-69	4.9	-3.4	-1.9	-6.5	0.3	3.2
SATA Vikas	1,380	4.9%	123	-51	-50	8.9	-3.6	3.6	-37.9	4.9	5.3
Magal Tech [^]	811	15.7%	105	15	15	12.9	1.9	6.7	8.8	2.9	5.0
Average		7.6%				9.6	-2.2	5.3	-1.4	1.4	27.3
Crankshaft											
Laxmi-Agni	2,861	16.7%	176	110	85	6.1	3.8	2.9	10.5	0.6	3.1
Bharat Forge	45,808	1.3%	10,673	5,840	4,672	23.3	10.2	8.7	8.7	0.6	3.0
Mahindra CIE ^{^^}	21,448	7.2%	2,123	1009	643	9.9	3.0	3.6	2.2	0.1	0.6
Sansera Engineering	12,657	10.9%	2,253	905	823	17.8	6.5	10.4	11.1	0.8	2.7
Amtek Auto [^]	11,431	-7.0%	469	-3566	-3,566	4.1	-31.2	-17.2	0.0	-1.2	240.5
Kay Jay Forge [^]	5,150	19.7%	355	92	57	6.9	1.1	11.0	7.9	1.7	3.5
Average		6.4%				12.4	-2.1	3.3	6	0.4	42.2
Rocker arm											
Sansera Engineering	12,657	10.9%	2,253	905	823	17.8	6.5	10.4	11.1	0.8	2.7
Bajaj Motors	6,113	2.1%	813	565	471	13.3	7.7	16.1	16.1	0.3	1.2
Schaeffler India ^{^^}	37,658	20.4%	5,408	2,937	2,910	14.4	7.7	13.2	9.5	0.0	0.0
Average		11.1%				15.2	7.3	13.2	12.2	0.4	1.3
Gear shift Fork											
Sansera Engineering	12,657	10.9%	2,253	905	823	17.8	6.5	10.4	11.1	0.8	2.7
RICO Auto	11,962	7.1%	837	137	167	7.0	1.4	4.2	2.9	0.7	4.8
Bajaj Motors	6,113	2.1%	813	565	471	13.3	7.7	16.1	16.1	0.3	1.2
Kalyani Forge	2,021	-3.1%	99	-81	-69	4.9	-3.4	-1.9	-6.5	0.3	3.2
Average		4.3%				10.8	3.1	7.2	5.9	0.5	3.0
Stem comp											
Endurance Technologies	69,266	7.2%	11,429	7478	5,680	16.5	8.2	23.1	21.9	0.3	0.7
Sansera Engineering	12,657	10.9%	2,253	905	823	17.8	6.5	10.4	11.1	0.8	2.7
Bajaj Motors	6,113	2.1%	813	565	471	13.3	7.7	16.1	16.1	0.3	1.2
Modern Automotive	2,324	17.3%	256	102	53	11.0	2.3	17.2	13.3	1.6	2.7
Average		9.4%				14.7	6.2	16.7	15.6	0.8	2.0

Note: N.A. – Not available for FY16 to FY20 or CY16 to CY20

[^]Financials not available for FY20, therefore figures for FY19

^{^^}Calendar year reporting

Note: Standalone financials considered and reclassified by CRISIL

Operating EBITDA: Indicates operating earnings before interest, taxes, depreciation and amortization which takes into consideration only operating income whereas non-operating income is excluded.

Operating EBITDA margin: Operating EBITDA / Operating income

PAT margin: PAT / Operating income

RoCE: PBIT / average of last two years total debt plus tangible net worth

RoE: PAT / average of last two years tangible net worth

Gearing ratio: Adjusted total debt / adjusted tangible net worth

Debt to EBITDA: Total debt to Operating EBITDA

Source: Company reports, MCA, Rating Rationales, company websites, CRISIL Research

Publicly listed top 10 auto component manufacturers in India by market capitalization

Companies/Particulars	Operating income (Rs mn)		Operating EBITDA (Rs mn)	PBT (Rs mn)	PAT (Rs mn)	Operating EBITDA margin (%)	PAT margin (%)	ROCE (%)	ROE (%)	Gearing ratio	Debt to EBITDA
	FY20	CAGR FY16-20	FY20	FY20	FY20	FY20	FY20	FY20	FY20	FY20	FY20
Motherson Sumi Systems Ltd	634,876	14.4%	52,042	20,258	11,735	8.2	1.8	12.0	11.4	1.1	2.3
Sundaram-Clayton Ltd	180,372	9.7%	5,932	8,363	6,266	3.3	3.5	11.9	17.6	3.4	20.3
Varroc Engineering Ltd	111,429	8.9%	8,942	314	-202	8	-0.2	3.5	-1.0	1.9	4.0
Bosch Ltd. (India)	97,216	0.4%	13,606	10,264	6,495	14	6.7	11.8	7.1	0.0	0.0
Bharat Forge Ltd	81,092	4.4%	11,903	4,536	3,412	14.7	4.2	6.9	6.5	0.8	3.7
Mahindra CIE Automotive Ltd*	60,501	3.2%	5,565	1,953	1,066	9%	2%	9.4	9.7	1.5	3.0
Endurance Technologies Ltd	69,266	7.2%	11,451	7,478	5,655	16.5	8.2	23.1	21.9	0.3	0.7
Minda Industries Ltd	54,654	21.2%	6,263	2,652	1,877	11.5	3.4	12.3	11.1	0.7	1.9
Sundram Fasteners Ltd	37,232	3.3%	6,044	3,932	3,265	16.2	8.8	14.9	16.9	0.4	1.4
WABCO India Ltd	19,309	1.2%	2,579	2,264	1,588	13.4	8.2	12.4	8.7	0.0	0.0
Average		7.4%				4.5	11.8	11.0	1.0	4.0	4.5

Notes: Consolidated Financials considered; reclassified as per CRISIL

* For calendar year 2020

Operating EBITDA: Indicates operating earnings before interest, taxes, depreciation and amortization which takes into consideration only operating income whereas non-operating income is excluded

Operating EBITDA margin: Operating EBITDA / Operating income

PAT margin: PAT / Operating income

ROCE: PBIT/average of last two years total debt plus tangible net worth

ROE: PAT/ average of last two years tangible net worth

Gearing ratio: Adjusted total debt/ Adjusted tangible net worth

Debt to EBITDA: Total debt to Operating EBITDA

(Source: Company reports, MCA, Rating Rationales, company websites, CRISIL Research)

OUR BUSINESS

Some of the information in this section, including information with respect to our plans and strategies, contains forward-looking statements that involve risks and uncertainties. You should read “Forward-Looking Statements” on page 21 for a discussion of the risks and uncertainties related to those statements and also “Risk Factors” on page 22. Our actual results may differ materially from those expressed in or implied by these forward-looking statements.

Our fiscal year commences on April 1 and ends on March 31 of the subsequent year, and references to a particular Fiscal are to the 12 months ended March 31 of that year. Unless otherwise indicated or as context requires otherwise, the financial information included herein is derived from our Restated Consolidated Financial Information, which are included in “Financial Statements” on page 219.

Industry and market data used in this section has been derived from the CRISIL Report and the Ricardo Report, both of which were commissioned by our Company in connection with the Offer for an agreed fee. For more details, see “Risk Factors - Statistical and industry data in this Red Herring Prospectus are derived from the CRISIL Report and the Ricardo Report, both of which were commissioned by our Company for the purpose of the Offer for an agreed fee. Each of the CRISIL Report and the Ricardo Report is not exhaustive and is based on certain assumptions, parameters and conditions. The data and statistics in the CRISIL Report and the Ricardo Report may be inaccurate, incomplete or unreliable” on page 52.

Overview

We are an engineering-led integrated manufacturer of complex and critical precision engineered components across automotive and non-automotive sectors. Within the automotive sector, we manufacture and supply a range of precision forged and machined components and assemblies, such as connecting rod, rocker arm, crankshaft, gear shifter fork, stem comp, and aluminium forged parts, that are critical for engine, transmission, suspension, braking, chassis and other systems for the two-wheeler, passenger vehicle and commercial vehicle verticals. Within the non-automotive sector, we manufacture and supply a range of precision components for the aerospace, off-road, agriculture and other segments, including engineering and capital goods. We supply most of our products directly to OEMs in finished (forged and machined) condition, resulting in significant value addition by us. For Fiscal 2021, we derived 88.45%, and 11.55% of our revenue from sale of products from the automotive sector and non-automotive sectors, respectively. We are a global supplier and for Fiscal 2021 we derived 64.98% of our revenue from sale of products from India and 35.02% of our revenue from sale of products from Europe, USA and other foreign countries combined.

We are one of the top 10 global suppliers of connecting rods within the light vehicle segment (passenger vehicles with gross vehicle weight of 3.5 tonnes or less, “**Light Vehicle**”) and one of the top 10 global suppliers of connecting rods within the commercial vehicle (“**CV**”) segment for CY 2020. (Source: the Ricardo Report, pages 42 and 43). We have been gaining market share in connecting rods in terms of production volume (units) for (i) Light Vehicles with a global market share of 2.3% in CY 2020 compared to a global market share of 0.9% in CY 2015 and (ii) CVs with a global market share of 3.0% in CY 2020 compared to a global market share of 0.9% in CY 2015. (Source: the Ricardo Report, pages 32 and 33).

Within India, we are one of the leading manufacturers of (i) connecting rods, crankshafts, rocker arms and gear shifter forks for two-wheelers and (ii) connecting rods and rocker arms for passenger vehicles. Specifically, we are the largest supplier of connecting rods, rocker arms and gear shifter forks to two-wheeler OEMs in India. We are the largest supplier of connecting rods and rocker arms to passenger vehicle OEMs in India. (Source: the CRISIL Report, pages 191, 194, 198 and 201).

We are a technology-driven company with a focus on design, engineering, machine building and automation capabilities. These capabilities enable us to roll out new products in a timely manner and develop higher strength components required for high-end performance and graduate from manufacturing individual parts to the designing and manufacturing of sub-assemblies, thereby moving us up the value chain. We possess machine building capabilities, with several complex special purpose machines being manufactured in-house. As of July 31, 2021, we had built over 900 computer numerical control special purpose machines, which are deployed across our manufacturing facilities. Most of the machines we build are modular by design and can be refurbished for other applications in case of a reduction in demand or a phasing out of the product for which the machine was originally built, thereby reducing our capital expenditure requirements and de-risking our business model. Our automation division, which works concurrently with our machine design and machine building divisions, has implemented multiple automation projects intended to increase our productivity and control labour costs. As of July 31, 2021, a team of 201 personnel supported our design, engineering, machine building, automation and technical support functions.

We believe our engineering capabilities, evolved over decades, have enabled us to consistently offer quality, complex, precision components and assemblies, allowing us to diversify our business beyond the automotive sector into various other sectors, including aerospace, off-road and agriculture. We sold components across 69 product families during Fiscal 2021 as compared to 51 during Fiscal 2019. Our recently developed products include (i) suspension, rotor and aluminium forged components for internal combustion engines (“**ICE**”) and electric two-wheelers (“**e-2W**”), (ii) steering system components and drive train parts for ICE and hybrid passenger vehicles, (iii) cabin tilt system components and braking system parts for CVs, (iv) suspension components for off-road vehicles, (v) common rail systems for agriculture and (vi) components for industrial engines within other non-automotive sectors. In addition, since April 1, 2021, we have developed (i) suspension and drive train components for electric two-wheelers, (ii) braking system components for passenger vehicles, (iii) machined engine casings for aerospace and (iv) components for power transmission. We also have an active pipeline of products under development, including

components for the defence sector and the bicycle segment. For further details, see “-Products Recently Developed / Under Development” on page 164.

Within India, our customers include nine out of the top 10 two-wheeler OEMs and the leading passenger vehicle OEM based on production volume for Fiscal 2021. (Source: the CRISIL Report, page 31). Globally, our customers include six out of top 10 global Light Vehicle OEMs and three of the top 10 global MHCV OEMs based on production volumes for CY 2020. (Source: the Ricardo Report, pages 6 and 18). Owing to the critical applications of our products and stringent quality requirements, we believe it is difficult for new players to become qualified or replace us in supplying the precision components we provide. This is corroborated by our status as a single source supplier in certain product categories for some of our key customers and by our long-standing relationships with several well-known Indian and global OEMs. In the two-wheeler vertical, we have relationships spanning over 20 years with HMSI, 25 fiscal years with Bajaj and over 20 years with Yamaha, the second, third and fifth largest two-wheeler Indian OEMs in terms of domestic production volume for Fiscal 2021, respectively. (Source: the CRISIL Report, page 31). In the passenger vehicle vertical, we have relationships spanning more than 30 years with Maruti Suzuki, the leading Indian passenger vehicle OEM in terms of domestic production volume for Fiscal 2021 (Source: the CRISIL Report, page 54), over 10 years with Stellantis N.V. (formerly Fiat Chrysler Automobiles), a leading European passenger vehicle OEM, (source: the Ricardo Report, page 6) and over 10 years with one of the leading North American passenger vehicle OEMs. We were suppliers to 71 customers during Fiscal 2021 as compared to 64 during Fiscal 2019, which helped to decrease our reliance on our top customer, Bajaj. For Fiscals 2021, 2020 and 2019, our top customer, Bajaj, contributed 20.75%, 22.08% and 22.71% of our revenues from sale of products, respectively.

We have received numerous awards over the years that bear testimony to our ability to successfully meet our clients' requirements. Some of our recent awards include: the "Zero Defect Supplies" and "Best Quality Supplier" awards from Toyota Industries Engine India Private Limited, received in 2021, "Silver Boeing Performance Excellence Award" from Boeing in 2020; "Powertrain Supplier of the Year" from Fiat Chrysler Automobiles (now called Stellantis N.V.) in 2019; "Zero Defect Supply" from Toyota Kirloskar Motor in 2019; and "Quality Performance Award" from Volkswagen AG in 2017. For further details, see "History and Certain Corporate Matters" on page 188.

As of July 31, 2021, we had 16 manufacturing facilities, of which 15 are in India in the states of Karnataka (Bengaluru, Bidadi, Tumkur), Haryana (Manesar), Maharashtra (Chakan), Uttarakhand (Pantnagar) and Gujarat (Mehsana), and one facility is in Trollhättan, Sweden.

Our manufacturing operations are (i) integrated across the product cycle with the entire manufacturing process (encompassing forging, heat treatment, precision machining, other specialized processing, assembly, testing and quality control) being carried out in-house and (ii) coordinated through concurrent design and engineering, machine building and automation divisions. This enables us to keep the core competencies required for our business within our Group, streamline our production processes, achieve shorter product development and delivery times, exercise greater control over key inputs and processes, reduce inventories and manage capital expenditure.

Our Company was incorporated on December 15, 1981. We commenced commercial production of passenger vehicle components in 1986 for Maruti Suzuki (formerly known as Maruti Udyog Limited). We then grew by commencing supplies to the two-wheeler vertical in 1996, to the off-road vehicle vertical in 2009 and to the light commercial vehicle vertical in 2011. We set up a manufacturing facility dedicated to high precision aluminium and titanium machined aerospace components in 2013. In 2017, we acquired a 100% stake in Sansera Sweden, which established our presence in the heavy commercial vehicle vertical. Further, we set up our aluminium forging lines in Fiscal 2020 in order to cater to the growing opportunities in the light weighting of vehicles. We are now in the process of setting up a dedicated facility for hybrid and electric components at one of our plants in Bangalore and we expect this facility to be commissioned during Fiscal 2022. We also plan to construct a greenfield manufacturing facility in Bangalore dedicated to aerospace and defence and we expect this facility to be commissioned during Fiscal 2023. For further details, see “-Manufacturing-Planned New Manufacturing Facilities” on page 174.

We are an employee driven, professionally managed organisation. Our management team is led by our Group CEO, Bindiganavile Raghunath Preetham, our Vice President of Group Operations, Praveen Chauhan, and our CFO, Vikas Goel, who are experienced professionals and are not related to the Promoters or the Promoter Group. The majority of our senior management have been with our Company for more than 10 years and have led the expansion of our product families and customer base, resulting in business growth and diversification. Our management team has ownership stakes in our Company through ESOP schemes with a view to align their interests with our performance.

Our total income increased by 6.74% to ₹ 15,723.64 million for Fiscal 2021 from ₹ 14,731.39 million for Fiscal 2020 and our profit for the year increased by 37.49% to ₹ 1,098.60 million for Fiscal 2021 from ₹ 799.05 million for Fiscal 2020. This performance was achieved in challenging market conditions. The two-wheeler and passenger vehicle segments in India registered a decline in production of 12.6% and approximately 11% over the same period, respectively, while the global Light Vehicle and CV segments registered a decline in production of 17.8% and approximately 4.4% during CY 2020, respectively. (Sources: the CRISIL Report, pages 25 and 50; the Ricardo Report, pages 5 and 17). Our performance was driven by an increase in revenue from new customers and/or new products. From the beginning of Fiscal 2019 to the end of Fiscal 2021, we increased the number of our customers by seven and added 18 new product families. For details, see “Management's Discussion and Analysis of Financial Condition and Results of Operations – Our Results of Operations” on page 300.

Our Company's long-term bank facilities are domestically rated by ICRA as [ICRA] AA-/Stable and by India Ratings as Ind AA-/Stable, and our Company's short-term bank facilities are domestically rated by ICRA as [ICRA] A1+ and by India Ratings as Ind A1+.

Our Strengths

A leading supplier of complex and high-quality precision engineered components that is gaining market share across automotive and non-automotive sectors

Precision components such as connecting rods, crankshafts and rocker arms are manufactured using complex engineering processes, and given their criticality to automotive systems, they require a high level of precision and adherence to high standards of quality. This requires close coordination between component manufacturers and OEMs throughout the product cycle from design to testing and validation to delivery. (Source: *the CRISIL Report, page 189*).

We are one of the top 10 global suppliers of connecting rods in terms of production volume (units) for (i) Light Vehicles with a global market share of 2.3% in CY 2020 compared to a global market share of 0.9% in CY 2015 and (ii) CVs with a global market share of 3.0% in CY 2020 compared to a global market share of 0.9% in CY 2015. (Source: *the Ricardo Report, pages 32 and 33*).

Within India, we are one of the leading manufacturers of (i) connecting rods, crankshafts, rocker arms and gear shifter forks for two-wheelers and (ii) connecting rods and rocker arms for passenger vehicles. Specifically, within two-wheelers, we are the largest supplier of connecting rods, rocker arms and gear shifter forks in India. Within passenger vehicles, we are the largest supplier of connecting rods and rocker arms in India. (Source: *the CRISIL Report, pages 191, 194, 198 and 201*).

We believe that our market position is the result of our established presence in the precision components manufacturing industry and our ability to manufacture and supply complex, high-quality precision components according to our customers' specifications, resulting in us being many of our customers' preferred supplier. Further, we are the single source supplier for certain components to select OEM companies in India and globally.

With a track record of developing complex and critical precision engineered components for the automotive sector over multiple decades, we believe our capabilities can be extended to manufacture precision components for several non-automotive sectors. This has been demonstrated by our already established presence in the aerospace, off-road and agriculture sectors, and by our continued or recently completed development of new products for various non-automotive sectors, such as (i) common rail for the agriculture sector, (ii) fan hub and compressor parts for industrial engines within the engineering and capital goods sector and (iii) components for the power transmission sector. Further, our existing components in the automotive sector have multiple applications across various non-automotive segments.

As at July 31, 2021, we have been awarded business from 35 customers in the automotive sector and from 21 customers in the non-automotive sector across our product portfolio, where the start of production is either during or after Fiscal 2021. For further details, see the tables under “– Business Pipeline” on page 167.

We believe we are well positioned to leverage our strengths towards expected growth in the automotive and non-automotive industries, particularly as OEMs are starting to outsource not only the manufacture of forged precision components but also the entire forging and machining operations of these components to integrated component manufacturers, including us. In addition, certain OEMs are seeking to consolidate their suppliers, particularly with suppliers who are able to manufacture complex and high-quality components, scale up production and supply products across a number of geographies. (Source: *the CRISIL Report, page 189*).

Well diversified business model

Our business model is well diversified by customer base, end segment, geographical spread of revenues and product portfolio.

Customer base: We have a diversified and increasing customer base. Within India, our customers include nine of the top 10 two-wheeler OEMs and the leading passenger vehicle OEM based on production volume for Fiscal 2021. Globally, our customers include six out of top 10 global Light Vehicle OEMs and three of the top 10 global MHCV OEMs based on production volumes for CY 2020. (Sources: *the CRISIL Report, pages 25 and 50; the Ricardo Report, pages 5 and 17*). We were suppliers to 71 customers during Fiscal 2021 as compared to 64 during Fiscal 2019 and are continuously pursuing new customer relationships.

The following table sets forth our revenue from sale of products from our top five customers and as percentage of our revenue from sale of products:

	Fiscal 2021		Fiscal 2020		Fiscal 2019	
	Revenue (₹ in million)	% of Revenue from Sale of Products	Revenue (₹ in million)	% of Revenue from Sale of Products	Revenue (₹ in million)	% of Revenue from Sale of Products
Customer 1	3,022.51	20.75%	3,075.30	22.08%	3,467.63	22.71%
Customer 2	2,038.98	14.00%	1,916.89	13.76%	1,870.94	12.25%
Customer 3	1,485.77	10.20%	1,312.98	9.43%	1,408.06	9.22%
Customer 4	1,309.20	8.99%	1,318.92	9.47%	1,577.60	10.33%
Customer 5	769.74	5.28%	658.52	4.73%	839.78	5.50%
Total top 5 customers	8,626.20	59.21%	8,282.60	59.46%	9,164.01	60.01%
Revenue from Sale of Products	14,568.90	100.00%	13,930.38	100.00%	15,269.81	100.00%

End segment: We derive our revenue from multiple segments within the automotive sector, including the two-wheeler, passenger vehicle and commercial vehicle verticals. Within the non-automotive sector, we manufacture and supply a range of precision components for the aerospace, off-road, agriculture and other segments, including engineering and capital goods. The tables below set out the revenues generated from various end-use segments and as a percentage of our revenue from sale of products.

	Fiscal 2021		Fiscal 2020		Fiscal 2019	
	Revenue (₹ in million)	% of Revenue from Sale of Products	Revenue (₹ in million)	% of Revenue from Sale of Products	Revenue (₹ in million)	% of Revenue from Sale of Products
Automotive Segments						
Two-wheelers	7,341.36	50.39%	7,007.29	50.30%	7,268.26	47.60%
<i>Of which:</i>						
<i>Scooters</i>	1,460.30	10.02%	1,639.37	11.77%	1,624.40	10.64%
<i>Motorcycles</i>	5,881.07	40.37%	5,367.92	38.53%	5,643.85	36.96%
Three-wheelers	115.65	0.79%	178.87	1.28%	226.16	1.48%
Passenger vehicles	3,514.64	24.12%	3,244.48	23.29%	3,671.52	24.04%
Commercial vehicles	1,914.71	13.14%	1,809.04	12.99%	2,254.59	14.77%
Sub Total (Automotive)	12,886.37	88.45%	12,239.68	87.86%	13,420.53	87.89%
Non-Automotive Segments						
Aerospace	547.88	3.76%	813.69	5.84%	675.26	4.42%
Off-road	607.75	4.17%	414.75	2.98%	555.36	3.64%
Agriculture	360.62	2.48%	299.75	2.15%	391.01	2.56%
Others	166.30	1.14%	162.50	1.17%	227.65	1.49%
Sub Total (Non-Automotive)	1,682.54	11.55%	1,690.69	12.14%	1,849.28	12.11%
Revenue from Sale of Products	14,568.90	100.00%	13,930.38	100.00%	15,269.81	100.00%

Geographical spread: We have focused on increasing our export revenues with a view to reduce dependence on the Indian market. Our revenues from sale of products are geographically diversified with Europe, USA and other foreign countries accounting for 35.02%, 30.62% and 31.00% of our revenue from sale of products in Fiscals 2021, 2020 and 2019, respectively. The following table sets out our revenue from sale of products by geographical spread for the fiscal years indicated:

	Fiscal 2021		Fiscal 2020		Fiscal 2019	
	Revenue (₹ in million)	% of Revenue from Sale of Products	Revenue (₹ in million)	% of Revenue from Sale of Products	Revenue (₹ in million)	% of Revenue from Sale of Products
India	9,466.78	64.98%	9,664.83	69.38%	10,536.15	69.00%
Europe (A)	3,640.52	24.99%	3,266.21	23.45%	3,682.89	24.12%
USA (B)	1,012.62	6.95%	709.86	5.10%	902.00	5.91%
Other foreign countries (C)	448.98	3.08%	289.48	2.08%	148.77	0.97%
Revenue from foreign countries (A+B+C)	5,102.12	35.02%	4,265.55	30.62%	4,733.66	31.00%
Revenue from Sale of Products	14,568.90	100.00%	13,930.38	100.00%	15,269.81	100.00%

Product portfolio: Within most of our product families, we manufacture a range of components for multiple end applications. For instance, our key product families such as connecting rods, rocker arms and crankshafts have multiple end use applications across both automotive (two-wheelers, passenger vehicles, commercial vehicles) as well as non-automotive (off-road, agriculture, engineering and capital goods, marine and others) sectors.

The following table sets out our revenue from sale of products by product families and as a percentage of total revenue from

sale of products:

Products	Fiscal 2021		Fiscal 2020		Fiscal 2019	
	Revenue (₹ in million)	% of Revenue from Sale of Products	Revenue (₹ in million)	% of Revenue from Sale of Products	Revenue (₹ in million)	% of Revenue from Sale of Products
Connecting rods	5,778.67	39.66%	5,213.35	37.42%	5,867.27	38.42%
Rocker arms	2,836.10	19.47%	2,899.88	20.82%	2,999.31	19.64%
Crank shaft assembly	2,509.90	17.23%	2,531.40	18.17%	2,878.08	18.85%
Gear shifter forks	959.06	6.58%	1,003.85	7.21%	1,277.60	8.37%
Stem comp	550.54	3.78%	144.39	1.04%	0.05	0.00%
Aerospace products	547.88	3.76%	813.69	5.84%	675.26	4.42%
Integral crankshaft	148.25	1.02%	139.38	1.00%	51.30	0.34%
Others	1,238.50	8.50%	1,184.45	8.50%	1,520.94	9.96%
Revenue from Sale of Products	14,568.90	100.00%	13,930.38	100.00%	15,269.81	100.00%

Our varied product offerings and continuous product development efforts have enabled us to cater to multiple sectors and customers, enhance our ability to attract new customers. We sold components across 69 product families during Fiscal 2021 as compared to 51 during Fiscal 2019.

The following chart depicts the timeline, in fiscal years, of securing business in relation to our key product families.

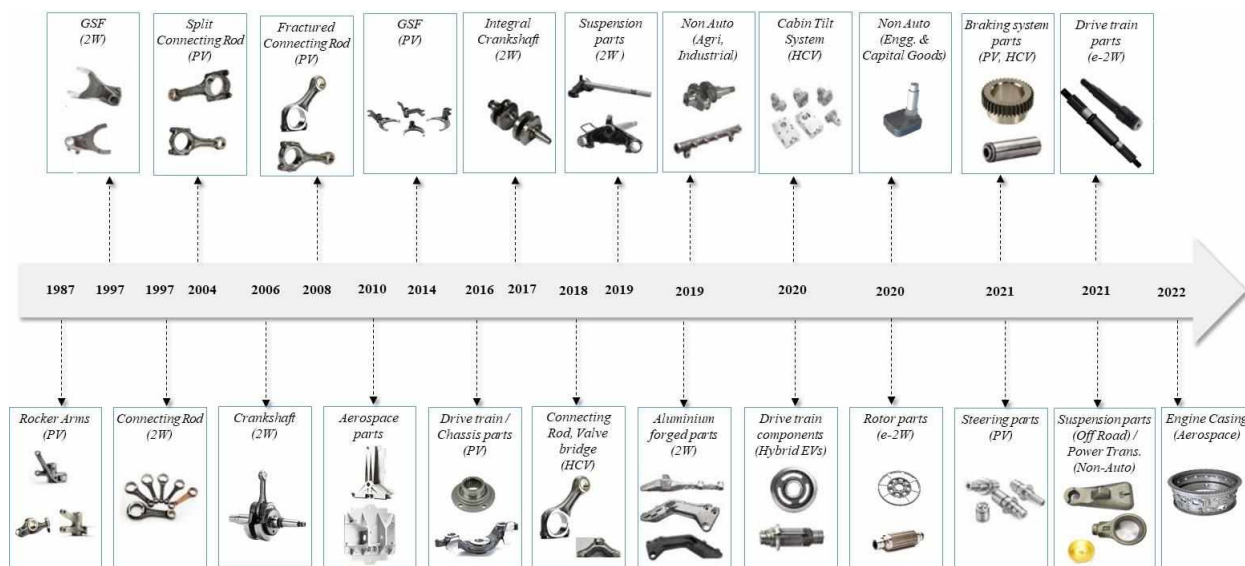

Advanced capabilities in design and engineering, machine building and automation resulting in continuous new product development and improved productivity, with fungibility of equipment, machinery and production lines across product families and sectors

We are engineering-led in our capabilities, with integrated operations across the product manufacturing cycle. As of July 31, 2021, we had a team of 201 personnel working on design, engineering, machine building, automation and technical support functions.

Design and engineering capabilities: Our design and engineering capabilities comprise product, process, machine, fixture and cutting tool design as well as advanced engineering capabilities, which have enabled us to support our customers through concurrent development of critical products and further strengthened our relationships. Examples include (i) high performance diamond-like carbon (“DLC”) coated rocker arms for reputed two-wheeler OEMs in the United States and Europe and for a leading European sports car OEM; (ii) precise and complex profile connecting rods for multiple global passenger vehicle OEMs; and (iii) braking system parts with critical profile resulting in import substitution for a leading Indian passenger vehicle OEM.

Our engineering capabilities also enable us to design new products from statements of requirements, validate our designs through software using FEA (finite element analysis), develop prototypes and perform relevant testing to confirm design robustness, all of which increase opportunities for us to secure higher value-added business with our customers and enables us to deepen our customer relationships through cost optimisation and reductions in development and testing time. Specific examples of proto parts development include: (i) medical implants for a leading U.S. customer; (ii) clutch assembly component for a leading global battery electric vehicle (“BEV”) OEM; and (iii) machined engine casings for aircraft engines.

Machine building capabilities: We possess integrated machine building capabilities with special purpose machines being manufactured in-house. Our computer numerical control (“CNC”) special purpose machines (“SPM”) are built in a separate dedicated facility, which employed 56 personnel as of July 31, 2021 and manufactured 65 machines during Fiscal 2021. We

manufacture advanced CNC SPMs, including automated cells, four station SPMs, vertical honing machines, double disc grinding machines, internal grinding machines, laser cracking machines, trumpet-form hole machines, balancing machines and laser structuring machines, which are deployed across our manufacturing facilities. The machines needed to manufacture several of the precision components in our product categories are expensive and generally imported in India. Hence, companies that have the ability to manufacture these machines in-house have an edge over their peers by deriving competitive benefits from such integrated machine building capabilities. (Source: the CRISIL Report, page 189). Our integrated machine building capabilities enable capital and operating efficiencies and help us to respond quickly to our customers' changing product specifications. As of July 31, 2021, we had built over 900 computer numerical control special purpose machines, which are deployed across our manufacturing facilities and which have reduced our reliance on third-party suppliers. Over the last few years, we have also deployed many of our own special purpose machines at our Swedish manufacturing plant that conform with the CE (Conformité Européenne) Mark.

Automation capabilities: Our automation capabilities enable us to combine operations and eliminate multiple operators in the production process in order to increase productivity, while controlling costs and maintaining consistent product quality. Our Company's automation division included a team of 27 personnel as of July 31, 2021 who work concurrently with machine and fixture design to implement automation projects intended to increase our productivity and control labour costs. Key automation projects already implemented in-house include fracture and bolt assembly cells, inspection cells, pick and place systems, material handling gantries, machine tending robots and assembly automation. As of July 31, 2021, we had numerous automation projects underway, with a number of these targeted for implementation during the current fiscal year. For details, please refer to “-Design and Engineering, Machine Building and Automation Capabilities” on page 186.

We have leveraged our design, engineering, machine building and automation capabilities in our existing production facilities to optimise cycle times to plan our personnel needs and enhance productivity. For example, in the case of our fractured-split connecting rod manufacturing lines, we were able to utilise our automation capabilities to reduce the number of manual operators per shift per line from 23 in 2010 to eight in 2019. Productivity of these lines increased production from 4,200 connecting rods per day in 2010 to 5,200 connecting rods per day in 2019. Further, we have deployed similar manufacturing lines for our newly developed suspension products, reaping similar benefits in manpower and productivity. In addition, we are in the process of extending these capabilities for our braking system components and our other existing product lines.

Fungibility of production lines: Our production line configurations are flexible, allowing us to interchange capacity and product mix between all our product categories within and across automotive and non-automotive sectors based on customer and operational requirements from time to time, enabling us to offer a diverse range of products and services to our customers. This optimises our machine productivity and operational efficiency and de-risks our business model.

For example, during Fiscal 2021, when the demand for aerospace components was extremely subdued, certain of our production lines dedicated for aerospace business were shifted and utilised for the production of automotive products. Further, during Fiscal 2020, our existing connecting rod manufacturing lines were also adopted for setting up production lines for suspension components.

Long-standing relationships with well-known Indian and global OEM customers

Within India, our customers include nine of the top 10 two-wheeler OEMs and the leading passenger vehicle OEM based on production volume for Fiscal 2021. Globally, our customers include six out of top 10 global Light Vehicle OEMs and three of the top 10 global MHCV OEMs based on production volumes for CY 2020. (Sources: the CRISIL Report, page 25 and 50; the Ricardo Report, pages 5 and 17).

We have long-standing relationships with several well-known Indian and global OEMs. Specifically, (i) in the two-wheeler vertical we have relationships of 25 fiscal years with Bajaj, over 20 years with Yamaha and over 20 years with HMSI, the third, fifth and second largest two-wheeler Indian OEMs in terms of domestic production volume for Fiscal 2021, respectively (Source: the CRISIL Report, page 31); and (ii) in the passenger vehicle vertical we have relationships of over 30 years with Maruti Suzuki, the leading Indian passenger vehicle OEM in terms of domestic production volume for Fiscal 2021 (source: the CRISIL Report, page 54), over 10 years with Stellantis N.V. (formerly Fiat Chrysler Automobiles), a leading European passenger vehicle OEM (source: the Ricardo Report, page 6), and over 10 years with one of the leading North American passenger vehicle OEMs.

We have relationships spanning 10 years or more with 12 of our top 20 customers. The table below sets forth the details of our relationships with our top 20 customers for Fiscal 2021.

S. No.	Name or Description of the Customer	Minimum number of fiscal years of customer relationship
1.	Maruti Suzuki India Ltd.	34
2.	Bajaj Auto Limited	25
3.	India Yamaha Motor	24
4.	Honda Motorcycle & Scooter India Pvt. Ltd	21
5.	CNH	14
6.	European 2W OEM	13

S. No.	Name or Description of the Customer	Minimum number of fiscal years of customer relationship
7.	Honda Cars India Ltd.	13
8.	Stellantis N.V.	13
9.	Raytheon (Collins/Goodrich)	12
10.	One of the leading North American PV OEMs	12
11.	Polaris Industries Inc.	11
12.	Royal Enfield Motorcycles Limited	10
13.	Subsidiary of one of the leading European suppliers of fuel injection systems	8
14.	Triumph Motorcycles	8
15.	Daimler India Commercial Vehicles Private Limited	7
16.	Toyota Kirloskar Motor Pvt. Ltd.	6
17.	Hero Motocorp Ltd.	5
18.	RK Thailand	5
19.	One of the leading Swedish OEMs	4
20.	Global Tier 1 supplier	4

We have been recognised with numerous awards by our customers for the quality of our products. In 2021, we received “Zero Defect Supplies” and “Best Quality Supplier (Auto)” awards from Toyota Industries Engine India Pvt Ltd. In 2020, we received the “Silver Boeing Performance Excellence Award” from Boeing. . In 2019, we received “Powertrain Supplier of the Year” from Fiat Chrysler Automobiles (now called Stellantis N.V.) and “Zero Defect Supply” from Toyota Kirloskar Motor. In 2018, we received “Supplier Quality Award” from KTM and “Quality Excellence Award” from India Yamaha Motors. We received the “Quality Excellence Award” from General Motors for 2021 and 2018, after having received four such consecutive awards between 2013 and 2016. In Fiscal 2017, we received the “Quality Performance Award” from Volkswagen AG, the “Best Quality Performance Award” from Fiat India and the “Delivery Performance Award” from Polaris.

Financial performance that has outperformed the industry trends, with industry leading metrics

In Fiscal 2021 compared to Fiscal 2020, two-wheeler production volume in India declined by approximately 12.6% and the passenger vehicle production volume declined by approximately 11%. (Source: the CRISIL Report, pages 25 and 50). In CY 2020 compared to CY 2019, the global Light Vehicle and CV segments registered a decline in production of approximately 17.8% and 4.4%, respectively. (Source: the Ricardo Report, pages 5 and 17). Despite these decreases in production volumes, our revenue from sale of products increased by 4.58% to ₹ 14,568.90 million for Fiscal 2021 from ₹ 13,930.38 million for Fiscal 2020.

In Fiscal 2020 compared to Fiscal 2019, two-wheeler production volume in India declined by 14.1% and the passenger vehicle production volume declined by 15%. (Source: the CRISIL Report, pages 25 and 50). In CY 2019 compared to CY 2018, the global Light Vehicle and CV segments registered a decline in production of approximately 22.5% and approximately 6.2%, respectively. (Source: the Ricardo Report, pages 5 and 17). Despite these decreases in production volumes, our revenue from sale of products decreased by only 8.77% to ₹ 13,930.38 million for Fiscal 2020 from ₹ 15,269.81 million for Fiscal 2019.

Further, over the preceding two challenging fiscal years, we have been able to increase our profits and reduce our borrowings. Our profit for the year (after tax) increased from ₹ 980.64 million in Fiscal 2019 to ₹ 1,098.60 million in Fiscal 2021 while our Net Debt reduced from ₹ 5,637.63 million in Fiscal 2019 to ₹ 4,846.07 million in Fiscal 2021.

We have managed to outperform the industry trends through the introduction of new product families and the acquisition of new customers. For details, see “Management’s Discussion and Analysis of Financial Condition and Results of Operations – Our Results of Operations” on page 300.

Our total operating income (revenue from operations) has grown at a CAGR of 12.8% from Fiscals 2016 to 2020 as compared to the average CAGR of 7.4% for the top 10 listed auto-component manufacturers in India by market capitalization, in the same period. (Source: the CRISIL Report, pages 210 and 217).

According to the CRISIL Report, as compared to the publicly listed top 10 auto-component manufacturers in India by market capitalisation, we are the top auto-component manufacturer in India in terms of operating EBITDA margin for Fiscal 2020 and one of the top five auto-component manufacturers in India in terms of profit after tax margin in Fiscal 2020.

Skilled and experienced board of directors and management team, with an employee culture that emphasises teamwork and collaboration across functions

Our Promoter, Chairman and Managing Director, Subramonia Sekhar Vasana, founded the Company in 1981 and continues to provide guidance on machine and automation design, metallurgical advancement and engineering, apart from overseeing overall performance of our Company. Our Promoter and Joint Managing Director, Fatheraj Singhvi, joined us on a full-time basis in 2006 and provides guidance on our strategy, customer relationships, finance, human resource development and CSR activities, apart from overseeing the general performance of our Company.

We are an employee-driven, professionally managed organisation. We take pride in our employee culture that emphasises teamwork and collaboration across functions, which helps ensure that our employees are able to suggest and implement ideas, regardless of their roles. Our management team is led by our Group CEO, Bindiganavile Raghunath Preetham, our Vice President of Group Operations, Praveen Chauhan, and our CFO, Vikas Goel, none of whom are our Promoters or family members of our Promoters. Bindiganavile Raghunath Preetham (Group CEO since 2013) has been with our Company for more than 28 years and has oversight across all areas of our business, including developing and maintaining relationships with our customers and suppliers. Praveen Chauhan (Vice President of Group Operations since 2016) has been with our Company for more than 16 years and is responsible for our day-to-day operations.

We believe our highly experienced and professional management team provides us with a key competitive advantage. Most members of our senior management have been with our Company for more than 10 years and have extensive experience in the precision components manufacturing industry, including in operations, business development, quality assurance, customer relationships and human resources. This results in effective operational coordination and continuity of business strategies. Our management team has led our organisation through multi-pronged diversification of the business, acquisitions and development of new systems and products over the last several years.

We are further supported by an experienced board of directors with diversified expertise. Raunak Gupta, nominee director of Client Ebene Limited, actively contributes to and participates in our growth and diversification strategy. We also have oversight from the Independent Directors on our board which include Muthuswami Lakshminarayan, an auto industry veteran with approximately 28 years of experience, of which over 21 years were at Bosch India Limited, Sylvain Bilaine, who worked with Renault for 26 years, as well as Revathy Ashok, who has previously worked at Tishman Speyer India Private Limited, Syntel Inc. and is a board member of various listed companies.

Our management team has ownership stakes in our Company through ESOP schemes with a view to align their interests with our performance. We also have incentive schemes for employees at various levels, as well as in-house talent development programmes and career progression pathways.

Our Strategies

Consolidate and strengthen global market share in our existing automotive product portfolio and diversify into new products to cater to the expected increase in electrification of vehicles

As OEMs focus their resources on the final assembly of vehicles, they are increasingly looking to external suppliers for content that they have previously produced in-house. This trend is underpinned by OEMs' growth outside their home markets, consumer expectations with regard to product complexity and feature integration and an increased focus on safety and the environment. (Source: the CRISIL Report, page 189). Accordingly, we intend to take advantage of this outsourcing trend that has led to an increase in OEM dependency on suppliers that are capable of managing complex component production while maintaining high quality standards across multiple geographies.

We intend to focus on consolidating our leading market share, both globally and in India across our existing product portfolio. Our long-standing experience in supplying most complex and critical engine and transmission components, makes us well positioned to diversify into other segments such as suspension, braking, steering, chassis and other systems within the automotive sector. Our recent foray into suspension products such as stem comp and scale up of this business over the last couple of years further corroborates our ability to continually diversify our business.

Further, we intend to develop multiple technology driven systems and components to cater to growing opportunities in electrification of vehicles. We are in the process of setting up a dedicated facility for hybrid and electric components in Plant 2 and we expect this facility to be commissioned during Fiscal 2022.

Two-wheelers

For Fiscals 2021, 2020 and 2019, our revenue from sales of products to the two-wheelers segment was 50.39%, 50.30% and 47.60% of our total revenue from sales of products, respectively.

Within the two-wheeler segment in India, we have a dominant position across all of our key product families. Specifically, we are the largest supplier of connecting rods, rocker arms and gear shifter forks, as well as a leading manufacturer of crankshafts, in the two-wheeler segment in India. (Source: the CRISIL Report, pages 191, 194, 198 and 201). CRISIL Research expects two-wheeler rocker arms, connecting rods, gear shifter forks and crankshafts in India to grow at a CAGR of 12.0%, 12.3%, 12.2% and 12.3%, respectively, over the next five years from Fiscal 2021 to Fiscal 2026. (Source: the CRISIL Report, pages 193, 196, 200 and 203).

We have been able to consolidate our market share in our key product categories in the two-wheeler segment over the years. We have recently added TVS Motor as our customer and have started supplying all our existing key products from Fiscal 2021. Further, one of the leading two-wheeler OEM has outsourced the connecting rod and crankshaft business to us, which was previously being carried out in-house by the same OEM. Our integral crankshaft products are currently being supplied to Royal

Enfield and a leading U.S. premium motorcycle brand and can be supplied to other customers. We intend to further continue to consolidate our market share by capitalising on the increasing outsourcing trend by the OEMs and by increasing content per vehicle for our existing customers.

CRISIL Research estimates that by Fiscal 2026, electric vehicle (“EV”) penetration in 2W-scooters will be approximately 25% to 27%, while EV penetration in 2W-motorcycles will be less than 1%. For Fiscals 2021, 2020 and 2019, our revenue from sales of products to the scooter segment was 10.02%, 11.77% and 10.64% of our revenue from sale of products, respectively, and our revenue from sales of products to the motorcycle segment was 40.37%, 38.53% and 36.96% of our revenue from sale of products, respectively.

As part of our strategy to diversify into technology agnostic products and to cater to growing opportunities with respect to electric powertrains, we have added multiple new components in the two-wheeler segment over the last couple of years:

- We are currently supplying our recently developed suspension component, stem comp, to one OEM. We commenced supplies of these components in Fiscal 2020 and for Fiscal 2021, our revenue from sales of stem comp was ₹ 550.54 million, representing 3.78% of our revenue from sale of products. CRISIL Research expects the two-wheeler stem comp market to grow at a CAGR of 13.8% over the next five years from Fiscal 2021 to Fiscal 2026. (*Source: the CRISIL Report, page 205*). We expect to consolidate our market share for this product by supplying to multiple customers across both ICE and electric two-wheelers.
- We have recently secured business with a leading electric-two-wheeler OEM for supplies of multiple precision forged and machined suspension and axle (drive train) components. CRISIL Research forecasts the two-wheeler axle market to grow at a CAGR of 13.5% over the Fiscal 2021 to Fiscal 2026 period. We commenced supplies of these components in August 2021 and we plan to supply similar components to other OEMs.
- Our aluminium forged products currently cater to high-end premium motorcycles. We commenced supplies of these components in Fiscal 2020. With the expected growth in the high-end premium motorcycles market and the expected growth in electrification of vehicles, we expect increasing usage of aluminium forged components going forward. CRISIL Research forecasts the demand for premium motorcycles to grow at approximately 14% CAGR over Fiscal 2021 to 2026 period. (*Source: the CRISIL Report, page 39*).
- We supply arm relay, a suspension system part, to a leading 2W OEM for their premium motorcycles. We expect the demand for this product to witness steady growth in line with the growing share of premium motorcycles. We intend to supply this product to other OEMs as well.

Passenger Vehicles / Light Vehicles

For Fiscals 2021, 2020 and 2019, our revenue from sales of products to the passenger vehicles segment was 24.12%, 23.29% and 24.04% of our revenue from sale of products, respectively.

Within the passenger vehicles segment in India, we are the largest supplier of connecting rods and rocker arms. (*Source: the CRISIL Report, pages 191 and 198*). CRISIL Research expects the passenger vehicle connecting rods, gear shifter forks and crankshafts market in India to grow at a CAGR of 12.9%, 13.5% and 14.0% and the passenger vehicle rocker arm market in India to decline at a CAGR of approximately 1.7%, respectively, over the next five years from Fiscal 2021 to Fiscal 2026. (*Source: the CRISIL Report, page 200*).

We are one of the top 10 global suppliers of connecting rods within the Light Vehicles segment. We have been gaining market share in connecting rods for Light Vehicles with a global market share of 2.3% based on our production volume (units) in CY 2020 compared to a global market share of 0.9% in CY 2015. (*Source: the Ricardo Report, page 32*). Ricardo expects the connecting rod market for the global Light Vehicles segment to increase at a CAGR of 2.7% from 289.3 million units in CY 2020 to 331.2 million units in CY 2025. (*Source: the Ricardo Report, page 31*).

We have secured multiple new programs for the supply of connecting rods across geographies from our existing customers and we expect to further consolidate our global market share in connecting rods. For details, see “-Business Pipeline - Automotive Pipeline” on page 167. We also expect to consolidate our market share going forward based on the continued need for connecting rods in all hybrid vehicles.

Ricardo estimates that between CY 2020 and CY 2025, share of hybrid vehicles (micro, mild and full) in the global Light Vehicles segment will increase from 61.2% to 70.2%, while BEV penetration in the global Light Vehicles segment is expected to reach 12.2% over the same period. (*Source: the Ricardo Report, page 8*). Within the Indian market, CRISIL Research estimates that by Fiscal 2026, EV penetration in passenger vehicles in terms of sales volume (units) will be approximately 4%. (*Source: the CRISIL Report, page 68*).

As part of our strategy to diversify into technology agnostic products and to cater to growing opportunities in electrification of vehicles:

- We have recently secured business for multiple drive train components, specifically for hybrid EVs, from a leading global passenger vehicle OEM. We expect to commence supplies of these components in Fiscal 2023. Ricardo expects the global market value for these hybrid components to grow from US\$343 million to US\$1,247.5 million, representing a CAGR of 29.4% over the five years to CY 2025. (Source: *the Ricardo Report, page 48*). We plan to increase the number of our customers we supply these components to and increase the number of components we supply for use in hybrid EVs.
- We have secured orders for braking system components from a leading Indian passenger vehicle OEM and for multiple steering components from an Indian Tier 1 supplier. We have also been supplying multiple drive train and chassis components for a global Japanese OEM. We plan to supply these components to other OEMs.
- We supply aluminium forged products developed for high-end two-wheelers. With growing light weighting and electrification trends, we expect increasing usage of aluminium forged components going forward in passenger vehicles and we plan to cater for these requirements.

Commercial Vehicles

For Fiscals 2021, 2020 and 2019, our revenue from sale of products to the CV segment was 13.14%, 12.99% and 14.77% of our revenue from sale of products, respectively.

We were one of the top 10 global suppliers of connecting rods within the CV segment in CY 2020. We have been gaining market share in connecting rods for CVs with a global market share of 3.0% based on our production volume (units) to the CV segment in CY 2020 compared to 0.9% in CY 2015. Ricardo expects the connecting rod market for CVs to grow at a CAGR of 0.7% to 35.9 million units by CY 2025 from 34.8 million units in CY 2020. (Source: *the Ricardo Report, page 33*).

We plan to further consolidate our global market share in connecting rods by increasing our share of business from existing customers and adding new customers. We have secured new programs for the supply of connecting rods across multiple geographies from our existing customers. In addition, we have secured business to supply one of our key product families, gear shifter forks, to CNHi and leading European CV OEMs, and added new customers, such as leading global suppliers of braking systems, across multiple new geographies in the CV segment. For details, see “-Business Pipeline-Automotive Pipeline” on page 167.

Ricardo estimates that BEV penetration in the global CV segment will reach 4.0% by CY 2025 to 6.9 million units. (Source: *the Ricardo Report, page 18*). Within the Indian market, CRISIL Research estimates that by Fiscal 2026, EV penetration in the overall commercial vehicles market will be approximately 4%, driven by electrification in light CVs and buses, while EV penetration in HCV market will be negligible. (Source: *the CRISIL Report, pages 87 and 88*).

As part of our diversification strategy, we have recently started supplying precision components for cabin tilt systems, which are part of the chassis of HCVs. We currently supply our components for the Indian arm of a global manufacturer of these systems and intend to increase our supplies and cater to global requirements of our customer. We have developed components that are part of the braking system of heavy commercial vehicles, such as guide bushes and integral crankshafts. We intend to increase the number of precision components that can be used in multiple subsystems of CVs.

For further details, see “- Business Pipeline – Automotive Pipeline” on page 167.

Continue to leverage our existing capabilities to diversify further into non-automotive businesses and expand addressable market

With a track record of developing complex and critical precision engineered components for the automotive sector over multiple decades, we believe our manufacturing capabilities can be extended to manufacture precision components for several non-automotive segments, such as aerospace, off-road, agriculture and engineering and capital goods. Further, our existing key product families in the automotive sector have multiple applications across various non-automotive sectors.

CRISIL Research expects the market for precision engineered components for non-automotive applications (including defence, engineering and capital goods, power, aircraft and other niche applications such as tractors, construction equipment, railways, medical etc.) to grow at a CAGR of approximately 8.3% over the next five years to reach ₹ 2,655 billion by Fiscal 2026 from ₹ 1,780 billion in Fiscal 2021. (Source: *the CRISIL Report, page 147*).

Within the non-automotive segment, we primarily focus on manufacturing precision engineered components that require complex engineering capabilities, resulting in high value addition by us.

Aerospace Sector

For Fiscals 2021, 2020 and 2019, our revenue from sale of products to the aerospace segment was 3.76%, 5.84% and 4.42% of our total revenue from sale of products, respectively.

Fleet renewal is likely to be the main driver of order books for Airbus and Boeing till CY 2025. China and India are expected

to be the first and third most important markets by delivery value. Aircraft deliveries by Airbus and Boeing are expected to increase at a CAGR of 10-12% between CY 2020 and CY 2025. (Source: the CRISIL Report, page 117).

Over the years, our strategy in the aerospace segment has been to increase our revenue by supplying high value components. We started by supplying components for cargo, structural, lighting and seating systems, with an objective to eventually graduate to supply critical and complex precision components for actuation systems and engine and landing gear systems.

- We have been supplying actuation components to Collins Aerospace for eventual supply to leading aircraft OEMs.
- We have secured business from a leading domestic aerospace supplier for manufacturing and supply of machined engine casings for aircraft engines.

We intend to increase the number of engine and landing gear components and graduate to supply of subsystems and assemblies. In addition, we plan to expand the end use application of our components from civilian aerospace to defence aerospace. In order to facilitate this strategy, we plan to construct a new greenfield manufacturing facility in Bangalore dedicated to aerospace and defence. This facility is planned to have a built up area of 13,020 square metres compared to a built up area of 4,000 square metres for our current facility for aerospace, which is Plant 9. We expect the facility to be commissioned during Fiscal 2023. For more details, see “-Manufacturing-Planned New Manufacturing Facilities” on page 174.

Off-road Sector

For Fiscals 2021, 2020 and 2019, our revenue from sales of products to the off-road segment was 4.17%, 2.98% and 3.64% of our revenue from sale of products, respectively.

All-terrain vehicles (“ATV”) sales volume (units) increased by 33.8% in the United States in CY 2020 on account of increased interest in recreational activities, a rise in rural demand for ATVs as a replacement for bikes, and increased demand for ATVs in agriculture and defence. (Source: the CRISIL Report, page 118).

On a high base of 2020, ATV sales volume (unit) is projected to grow at 3-5% CAGR between CY 2020 and CY 2025. (Source: the CRISIL Report, page 119).

We have recently secured additional business for supplying multiple new components, including suspension parts, for an existing customer’s new program. We have also added another customer in the off-road segment for eventual supplies in Canada and the European Union. We intend to increase our revenue from the off-road sector by adding new products and customers.

Agriculture Sector

For Fiscals 2021, 2020 and 2019, our revenue from sale of products to the agriculture segment was 2.48%, 2.15% and 2.56% of our revenue from sale of products, respectively.

The global tractor market is expected to grow at a CAGR of 5.0% to reach 2.8 million units by CY 2025 from 2.2 million units in CY 2020. (Source: the Ricardo Report, page 24).

As per CRISIL Research, the Indian tractor market is expected to grow at a CAGR of 0 to 2% to reach 1.03 million units by Fiscal 2026 from 965,000 units in Fiscal 2021. (Source: the CRISIL Report, page 130).

We have developed several new components for the agriculture sectors, such as a common rail for tractors and Euro VI fuel pump components. Further, we have secured new business from existing customers for supplying our existing and new components. We intend to increase our revenue from the agriculture segment by adding new products and customers.

Other Non-Automotive Sectors

For Fiscals 2021, 2020 and 2019, our revenue from sale of products to other non-automotive sectors was 1.14%, 1.17% and 1.49% of our total revenue from sale of products, respectively.

- We have developed and started supplying multiple components including connecting rods for industrial engines and construction equipment. In addition, we have added multiple new products such as fan hub for various industrial applications.
- Some of the other components we have developed for non-automotive sectors include precision components for the power transmission and railways segments.
- We supply various components catering to power tool segment demand from residential and industrial sectors. Our key customers include a leading global power tools manufacturer and an Indian Tier 1 supplier.

We plan to develop and manufacture additional precision components for other non-automotive applications where we can

leverage our engineering capabilities.

For further details, see “– *Business Pipeline – Non-Automotive Pipeline*” on page 168.

Retain and strengthen our technological leadership through continued focus on our engineering capabilities

Our customers’ demand for higher performance and top-quality products is growing. In response to this, we have placed emphasis on continually improving our design and engineering capabilities so that we can focus on providing high value-added and technology-driven components, which we expect will present us with opportunities to capture shifts in customer preferences as well as evolving regulatory requirements, such as heightened emissions control standards. Further, this would increase opportunities for us to become a preferred supplier to our customers, thus giving us the opportunity to consolidate our position with our customers.

Leveraging our years of engineering know how in product design, validation through simulation, testing and manufacturing engineering, we have recently developed or are currently developing (i) complex machined drive train components for hybrid transmission systems in passenger vehicles; (ii) intricately shaped aluminium forged and machined components for ICE and electric two-wheeler; (iii) multiple complex and high precision finger followers with diamond-like coating for two-wheeler and passenger vehicles, and (iv) gear shifter forks with moly coating (for high wear resistance) and case carburised split connecting rods for super premium motorcycles for multiple global OEMs.

Further, our machine building, automation and advanced engineering capabilities enable us to de-risk our business against product obsolescence and reconfigure machines to suit new products in various verticals.

To enhance our capabilities, we have undertaken a number of initiatives:

- We have commissioned a new fatigue testing machine, with which we have tested our products to conform design assumptions or characteristics. We expect this to further enhance our ability to analyse and enhance product reliability, durability and performance.
- We have added five-axis machining capabilities for machining large structural components for aerospace, both in aluminium and other precious metals.
- We have commissioned aluminium forging lines complementing our existing machining capabilities, which we believe will make us well-positioned to capitalise on the growing demand and increasing need for components that are lighter in weight and environmentally friendly, as OEMs strive to reduce the ecological footprint of their vehicles.

Focus on operational efficiencies to improve returns

We have been able to deliver a RoCE of 15.11%, 12.88% and 19.36% for Fiscals 2021, 2020 and 2019, respectively, in challenging market conditions. For details on our RoCE, see “*Management’s Discussion and Analysis of Financial Condition and Results of Operations – Key Performance Indicators and Certain Non-GAAP Measures*” on page 288. We continue to focus on improving operational efficiency, including by way of the following key initiatives:

- Our operations are integrated across the product cycle, and almost all of our manufacturing processes (encompassing forging, heat treatment and machining) are carried out in-house. This allows us to respond quickly and efficiently to any customer requirements or changes in product specifications without needing to depend on any external vendors. This helps us closely monitor product quality, production costs and delivery schedules.
- Our ability to design and build computer numerical control special purpose machines allows us savings in operational and capital expenditure through savings in capital cost, footprint, power and maintenance costs, etc. which would otherwise have been higher. This is because we are able to build these machines only for the specific process required rather than having to purchase standard machines, which are generally built to cater for several processes as against a specific process requirement. Further, we are able to reconfigure these machines to be used interchangeably across products and verticals, thus de-risking our business.
- We have adopted a number of initiatives to increase our operational efficiency, such as (i) improving production line output by constantly improving productivity at the bottleneck operation through implementing TPM (total productive maintenance) methodology on the shop floor and balancing line output through partial investments (if required), (ii) inventory management (working towards single piece flow and streamlining material movement), (iii) optimising shop floor layouts through simulation software to streamline people and material movement, (iv) utilising simulations to improve input raw material yield in forgings, (v) optimising tool consumption to increase tool life and reduce costs, (vi) reduction in internal rejection or rework by streamlining manufacturing processes, and (vii) energy costs reduction through efficient power sourcing and reduction in consumption through implementation of EMS (energy management systems), with all our plants being EMS certified by TUV NORD.
- We have implemented several automation projects in-house, including pick and place systems, material handling

gantries, machine tending robots, automated assembly and automated inspection cells. We have automated a number of our forging and machining operations and as at July 31, 2021, we had more than 130 robots installed across all our manufacturing facilities in India.

- We have a practice of sharing and horizontally deploying kaizens and QCC (quality controls circles) results implemented in any one plant, across various plants. This helps plants to improve SPQCD (safety, productivity, quality, cost and delivery) simultaneously. This practice is monitored centrally as a corporate function.
- We closely monitor operational efficiency at each of our individual plants, benchmarking performance to relevant key performance indicators through which we distribute our business to optimise capacity utilization at each plant.

Corporate Structure

The chart below sets forth the corporate structure and ownership of our Company and our Subsidiaries as on the date of this Red Herring Prospectus.

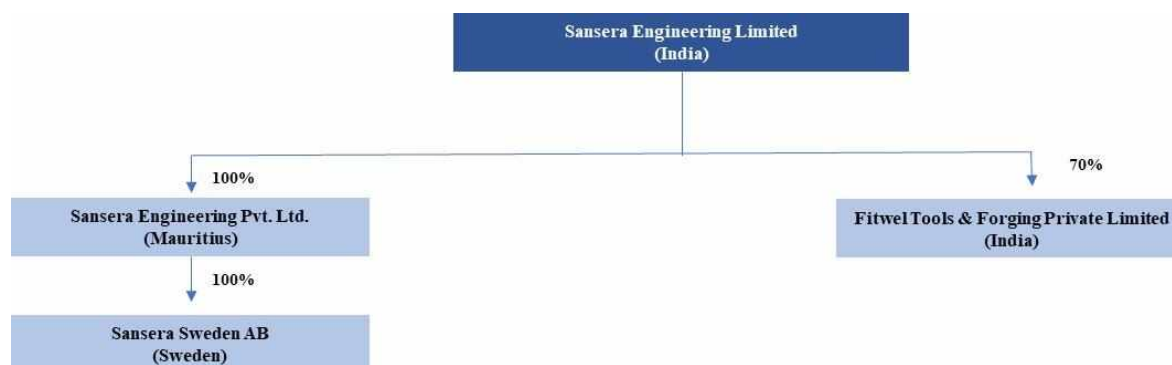

Notes:

- (1) For details of the shareholding of our Company, see “Capital Structure” on page 68.
- (2) The remaining 30.00% in Fitwel is owned by Doddaballapur Ramarao Subramanya and his family.

Our Subsidiaries

Fitwel

Fitwel commenced commercial production in 1987 with the manufacturing of hand tools as its core business. Fitwel supplies forged and machined components for automotive as well as non-automotive segments such as agriculture, engineering and capital goods, railways and others. Our Company has a 70.00% stake in Fitwel. Fitwel owns two plants in Tumkur and its manufacturing facilities include multiple forging lines comprising hammers, friction screw press and pneumatic press lines along with several CNC machining lines. Fitwel supplies components to our Company and various other customers. For further details, see “-Manufacturing – Facilities” on page 173.

Sansera Mauritius

Sansera Mauritius, in which our Company has a 100% stake, owns a 100% stake in Sansera Sweden. Sansera Mauritius does not have any operations.

Sansera Sweden

In April 2017, Sansera Mauritius acquired a 100% stake in Sansera Sweden, which is primarily engaged in the manufacturing of connecting rods for heavy commercial vehicles mostly in the European market. Sansera Sweden runs its operations from one manufacturing facility in Trollhättan, Sweden. For further details, see “-Manufacturing” on page 173.

For more details on our Subsidiaries, see “History and Certain Corporate Matters - Our Subsidiaries” on page 193.

Our Products

We manufacture and supply a range of precision forged and machined components with close tolerances (as low as three to 10 microns) that are critical for engine, transmission suspension, braking, chassis and other systems for the two-wheeler, passenger vehicle and commercial vehicle verticals in the automotive sector. We also manufacture and supply a range of precision components for non-automotive sectors, such as aerospace, off-road, agriculture and other segments, including engineering and capital goods.

Most of the components that we supply are fully finished. For some of our customers, we may start supplying semi-finished products and eventually progress towards supplying products in fully finished form. For example, we supply fully finished crankshafts to Yamaha, having graduated from supplying crankshafts in semi-finished condition. Similarly for Toyota, we

started supplying multiple components in semi-finished form and now also supply many components in fully finished form. We also currently supply split and integral crankshafts to some of the leading 2W OEMs in semi-finished form. Our strategy is to graduate to supplying these products in fully-finished form, thereby enhancing our value addition.

In order to increase our share of business with customers, we typically enter into a new customer relationship with one or a few product families, seeking to demonstrate the quality and cost efficiency of our products before seeking to strengthen our relationship by expanding into other product lines, which results in overall business growth. For example, we supplied three product families to Royal Enfield in Fiscal 2014, and in Fiscal 2021, we supplied them six product families. Similarly, we supplied two product families to TVS Motor in Fiscal 2019 and in Fiscal 2021, we supplied them seven product families.

The key product families that we manufacture for various verticals in the automotive and non-automotive sectors, are as follows:

Sector/Segment/Vertical	Product families supplied
Automotive	
Two-wheelers	Connecting rod, rocker arm, gear shifter fork, crankshaft assembly, stem comp, integral crankshaft, aluminium forged components
Passenger vehicles	Connecting rod, rocker arm, sprocket, gear shifter forks, yoke universal joint, rocker shaft, hub front axle, end rear axle
Commercial vehicles	Connecting rod, cabin tilt systems, integral crankshaft, bracket, pump barrel
Non-Automotive	
Aerospace	Multiple products for various subsystems such as aerostructure, actuation, equipment housing, cargo, seating and lighting
Off-road	Crankshaft assembly, balancer shaft, connecting rod, gear shifter fork
Agriculture	Cam shaft, connecting rod, pump barrel, lever, link
Others	Connecting rod, pump barrel, integral crankshaft

As of March 31, 2021, our Company supplied 69 product families. Our product range has grown consistently as shown in the table below:

	As of March 31, 2021	As of March 31, 2020	As of March 31, 2019
Number of Product Families	69	58	51

Details of the key product families that we manufacture for our customers are as follows:

Products common for Automotive and Non-Automotive segments

Connecting Rod: A connecting rod is a critical component and converts the reciprocating motion of a piston into the rotary motion of a crankshaft and vice versa. Since the connecting rod is a moving part in an engine and is subject to wear and tear, the tensile strength of the connecting rod is a key parameter for consideration in the designing process.

Connecting rods may be integral, split or fractured-split and find usage in multiple automotive and non-automotive applications as depicted below.

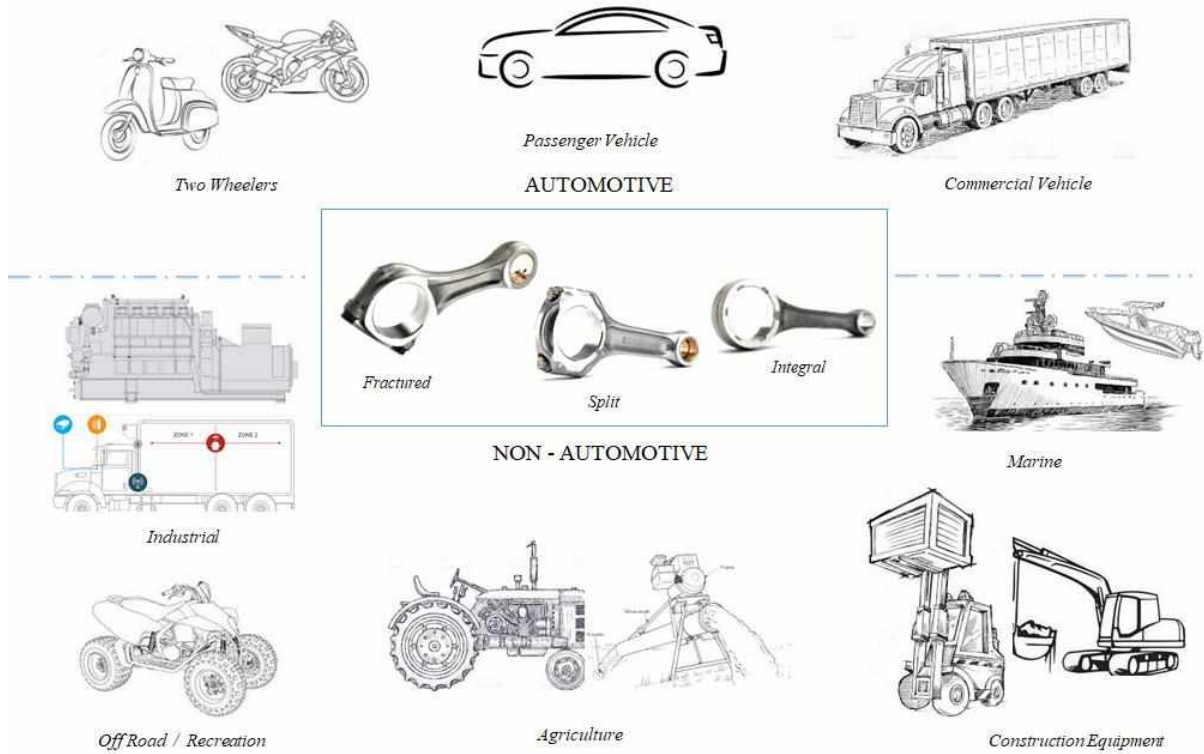

Integral connecting rods are used by two-wheelers and off-road vehicles, split connecting rods by two-wheelers, passenger vehicles and light commercial vehicles, and fractured-split connecting rods by two-wheelers, passenger vehicles, commercial vehicles and various non-automotive segments such as, off-road vehicles, tractors, construction equipment and various industrial applications.

Rocker Arm: A rocker arm is an oscillating lever that conveys radial movement from the camshaft into linear movement at the intake or exhaust valves. The rotating camshaft pushes the rocker arm up and down, allowing the intake or exhaust valves to be opened and closed. A rocker arm is in continuous contact with the valve, which produces a lot of friction. Therefore, the raw material used is carefully selected such that the noise produced by the engine is reduced, the weight of the rocker arm is lower and the rocker arm has more strength for higher efficiency in operations.

Rocker arms come in various configurations, such as chrome plated, sintered tip, roller type and DLC-coated. DLC rocker arms find applications in premium 2Ws and high-performance passenger vehicles.



Crankshaft: The crankshaft is a critical part in an engine's assembly that is connected to the piston on one side and the flywheel on the other. A crankshaft converts reciprocating motion of the pistons into rotational motion for the flywheel, which is in turn connected to the axles to put the vehicle in motion.

Crankshafts are available in two configurations, namely integral (single piece) and built-up. Built-up crankshafts are primarily used in single cylinder engines of two-wheelers with less than 300 cc capacity and off-road vehicles.

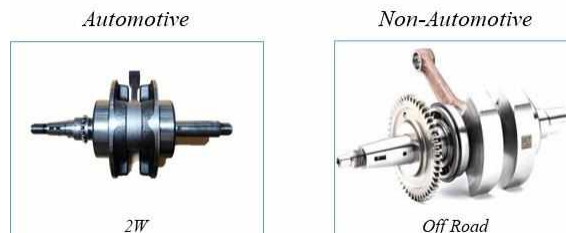

Integral Crankshaft: As there are limitations on the ability of built-up crankshafts to bear the force exerted by pistons (during a power stroke), integral (single piece) crankshafts are preferred for higher cc engines such as premium motorcycles and passenger vehicles on account of their ability to reduce vibrations and control balancing. In the case of integral crankshafts, the crank pin is integral to the rest of the crankshaft, rather than being press fitted as in the case of built-up crankshafts. As this design renders the manufacturing process from forging to machining more complicated, a higher tonnage capacity of forging presses as well as special and more costly machines for various machining operations are required.

We set up an integral (single piece) crankshaft line in 2015, keeping in view the gradual shift towards the premium bikes in the domestic market and a substantial opportunity available in the export market. Further, integral crankshafts also find application in braking systems of CVs as well as in industrial engines.



Gear Shifter Fork: A gear shifter fork is used to slide gears into or out of engagement with other gears to change the gear ratio in a manual transmission.

We supply induction hardened, chrome-plated and DLC-coated gear shifter forks for automotive and non-automotive segments.



Automotive Products

Stem Comp: Stem comp is the intermediate part of the front-fork assembly in a two-wheeler, and it connects with the handlebar at the top of the assembly and mates with suspension guides in the lower part of the assembly. The role of the component is to withstand torsional stress and enable manoeuvrability of the front wheel.



We received a letter of intent from a leading two-wheeler OEM for supply of stem comp in Fiscal 2019 and commenced mass production in Fiscal 2020. For Fiscal 2021, our revenue from sales of stem comp was ₹ 550.54 million, representing 3.78% of our revenue from sale of products.

Aluminium forged components: With the worldwide introduction of stringent emission norms, light weighting of vehicles has become one of the key focus areas, especially in premium vehicles. Our recently demonstrated capabilities in aluminium forging

complement our existing machining capabilities, which we believe make us well-positioned to capitalise on the growing demand and increasing need for lighter, more environmentally friendly components.

We received a letter of intent from a leading two-wheeler OEM for supply of multiple aluminium forged components for their premium motorcycles in Fiscal 2019. These components have intricate machining requirements given their aesthetic use in premium vehicles. We commenced mass production of these components in Fiscal 2020 after the commissioning of our first aluminium forging press. For Fiscal 2021, our revenue from sales of aluminium forged products was ₹ 98.74 million, which represented 0.68% of our total revenue from sale of products. Our second press was commissioned in January 2021 to tap growing opportunities in this segment.



Non-Automotive Products

Components for Aerospace: We supply multiple components within various sub systems of an aircraft such as aerostructure, actuation, equipment housing, cargo, seating and lighting.



Components for Off-road Segment

Our key product families for the automotive segment, such as crankshaft assembly, balancer shaft, connecting rod and gear shifter fork, are also supplied for use in recreational vehicles, such as ATVs.

Components for Agriculture Segment

We supply multiple types of cam shaft forgings to a leading Indian diesel fuel injection system supplier for applications in segments such as agriculture and marine. We also supply pump barrels, which are a common feature in all diesel fuel pumps and find application in agriculture and construction equipment segments.



Installed Capacity and Capacity Utilisation by Product Family

The table below sets forth the installed capacity and capacity utilisation of our product families.

Products	Installed Capacity and Capacity Utilisation					
	Fiscal 2021		Fiscal 2020		Fiscal 2019	
	Installed capacity ⁽¹⁾ in units	Capacity Utilisation ⁽²⁾ (%)	Installed capacity ⁽¹⁾ in units	Capacity Utilisation ⁽²⁾ (%)	Installed capacity ⁽¹⁾ in units	Capacity Utilisation ⁽²⁾ (%)
Connecting rods	29,566,200	56%	28,557,000	58%	29,031,600	72%
Rocker arms	48,990,000	55%	47,040,000	61%	44,160,000	80%
Crankshafts	5,784,000	67%	5,427,000	72%	5,427,000	84%
Gear shifter forks	23,580,000	55%	23,932,800	55%	23,932,800	89%
Stem comp	1,920,000	51%	1,920,000	20% ⁽³⁾	-	-
Aerospace products	252,282	48%	260,981	86%	243,582	77%
Integral crankshaft	378,000	31%	330,000	24%	330,000	14%
Others ⁽⁴⁾	N/A	N/A	N/A	N/A	N/A	N/A

Notes:

- (1) Installed capacity varies with product mix based on cycle times.
- (2) Capacity utilisation in Fiscal 2021 is computed as volume of products sold in Fiscal 2021 divided by the total installed capacity of products at the end of Fiscal 2020. The same basis applies for the calculation of capacity utilisation in Fiscals 2020 and 2019.
- (3) For Fiscal 2020, capacity utilisation for stem comp is computed based on the number of months of installed capacity available during Fiscal 2020. Commercial production of stem comp started in August 2019.
- (4) Others comprise multiple product families and the capacity is fungible.

Products Recently Developed / Under Development

Automotive Components

Components for Electric Two-wheelers

Drive Train Components

An axle is used as a mounting point to integrate the wheel with the steering assembly on the front side of a two-wheeler. On the rear side, the axle is used to integrate the wheel with the prime mover or hub of the vehicle. Axles are used in motorcycles, scooters and mopeds. Each two-wheeler (including electric two-wheelers) comes with a pair of axles – a front axle and rear axle. (Source: the CRISIL Report, page 206).



Suspension Components

Torque links are components used to link the fork assembly and suspension to the wheel on the front side of scooters. Torque links play a critical role in improving ride quality of the scooter by absorbing the jerks / load on the front wheel and minimising the load on the front shock absorber. Usage of torque links depends on the design of the scooter and a few upcoming models have been designed to have a pair of torque links comprising upper and lower torque links. (Source: the CRISIL Report, page 208).

We received a letter of intent from a leading electric two-wheeler OEM for supply of the above drive train and suspension components in Fiscal 2021. These components are a mix of steel and aluminium forgings with precision machining requirements. We commenced supplies of these components during August 2021.

Components for BEVs

Drive Train Components

We are currently developing proto samples for drive train components for a leading global BEV OEM.

Components for Hybrid EVs / BEVs

Drive Train Components

Motor generator shaft can potentially be used in several hybrid / BEV architectures, including those in which separate transmission has not been provided for motor. The rest of the parts (i.e., pinion differential drive and gear counter drive) can find usage in hybrid architectures that feature modified / specific transmission for motor. (Source: the Ricardo Report, page 46).



We received a letter of intent from a leading global passenger vehicle OEM in Fiscal 2021 for development of the above components for hybrid EVs. We expect to commence commercial supplies of these components during Fiscal 2023.

Components for Passenger Vehicles

Steering System Components



Input shafts are part of the steering assembly of a vehicle and are required for hydraulic assist steering. This is a common feature in vehicles above the compact SUV segment and its usage is expected to increase as customers become more quality focused.

We have recently developed these steering system components for an Indian supplier to PV OEMs for onward supplies to a global steering system player. We started supplying these components in June 2021.

Braking System Components



A ring retainer is a braking system component in passenger vehicles. We have received a letter of intent from a leading passenger vehicle OEM during Fiscal 2021 for the supply of ring retainers and we expect to start supplies in Fiscal 2023.

Components for HCVs

Chassis (Cabin Tilt System) Components

Cabin tilt systems are part of the chassis of HCVs and are used to tilt the driver's cabin and enable easy access of under-cabin parts. The addition of a cabin tilt system provides safety and saves valuable time for service centres and fleet owners. A common feature in overseas markets so far, the usage of these systems in Indian markets is expected to increase. We have developed multiple components for cabin tilt systems for a global supplier of these systems and supplies commenced in Fiscal 2021.



Braking System Components

A guide bush is a braking system component used in disc brake assembly of MHCVs. We have received a letter of intent from a leading global supplier of braking systems in Fiscal 2021 for the supply of guide bushes and we expect to commence supplies from Fiscal 2022.



Non-Automotive Components

Components for Aerospace

Machined Engine Casings

We have received a letter of intent to develop machined engine casings from a leading aerospace organisation in April 2021 and we started supplies in July 2021. The engine casing involves complex and intricate machining on a 5-axis simultaneous multitasking machines using advanced cutting tools.



Components for Off-road

Suspension Parts

Taper housing and bearing housing are part of the suspension system for ATVs and connect the suspension with the wheel. Processing of these parts involves welding as well as precision machining. We received a letter of intent to supply these components from one of our existing customers in Fiscal 2021 and we started supplies in June 2021.



Components for Agriculture

Common Rail

Common rail is an integral part of Common Rail Direct Injection (“**CRDI**”) systems for diesel engines. CRDI systems are popular for agriculture and CV applications due to their higher fuel efficiency. Processing of these parts involve high precision machining including a deep hole drilling of a very long length. Metallurgically, common rails call for very high precision control. We have received a purchase order to supply common rail systems in Fiscal 2021 and we expect to start supplies in Fiscal 2023.



Business Pipeline

As at July 31, 2021, we have been awarded business from 35 customers in the automotive sector and from 21 customers in the non-automotive sector across our product portfolio. The tables below set forth a list of this business awarded to us up to July 31, 2021, along with their corresponding details, where the start of production is either Fiscal 2021 or a period subsequent to Fiscal 2021. Accordingly, some of these programs have commenced production in Fiscal 2021, while others are expected to commence production in a period subsequent to Fiscal 2021. There is no assurance in relation to the sales volumes and revenue that any of these programs will eventually generate for us.

Automotive Pipeline

S. No	Customer	End Segment	# of LOI / PO	Application	Customer Location	
1	Indian OEM of Electric 2Ws	Electric 2W (Scooter)	1	Drive Train, Suspension	India	
2	Leading Indian 2W OEM - 1	2W (Scooter and Motorcycle), 3W	9	Engine, Transmission	India	
3	Leading Indian 2W OEM - 2	2W (Motorcycle)	5	Engine	India	
4	Chinese 2W OEM		1	Transmission	China	
5	European 2W OEM - 1		1	Transmission	EU	
6	Leading Indian 2W OEM - 3		2	Engine, Transmission	India	
7	Leading Indian 2W OEM - 4		12	Chassis, Engine, Suspension, Transmission	India	
8	Leading Global 2W OEM		2	Engine	Asia	
9	Indian 2W OEM		4	Engine, Transmission	India	
10	Leading Indian 2W OEM - 5		4	Engine	India	
11	European 2W OEM - 2		2	Chassis, Engine	EU	
12	European 2W OEM - 3		1	Engine	EU	
13	European 2W OEM - 4		1	Transmission	EU	
14	European 2W OEM - 5		1	Engine	EU	
15	Leading Indian 2W OEM - 6		1	Engine	India	
16	European 2W OEM - 6		2	Transmission	EU	
17	UK 2W OEM		20	Engine, Transmission	UK	
18	Chinese 2W, ATV OEM		2	Engine, Transmission	China	
19	Indian EV OEM		e-2W (Motorcycle)	1	Rotor	India
20	Leading Global PV OEM		Hybrid EVs	4	Chassis, Drive Train, Engine	India
21	Global PV OEM - 1	PV	2	Engine	USA	
22	Tier 1 powertrain supplier to Global PV OEM		1	Engine	Asia	
23	Leading Indian PV OEM		5	Braking systems, Engine	India	
24	Global PV OEM - 2		1	Engine	India	
25	Indian Tier 1 supplier to PV and CV OEMs		1	Steering systems	India	
26	Manufacturer of fuel injection systems		1	Fuel injection systems	India	
27	Global CV OEM		Electric CV / CV	5	Engine, Transmission	EU
28	Global supplier of braking systems - 1	CV	1	Braking Systems	USA	
29	Global supplier of braking systems - 2		3	Braking Systems	EU / India	
30	European CV OEM - 1		2	Engine, Transmission	EU	
31	European CV OEM - 2		1	Transmission	EU	
32	Global supplier of actuation and motion control systems		5	Chassis (Cabin Tilt System)	India	
33	Supplier of critical parts for auto, defence, railways etc.		7	Transmission	India	
34	Indian arm of global manufacturing and supply chain management company		1	Chassis	India	
35	Global engine manufacturer - 1		2	Engine	India	

Non-Automotive Pipeline

S. No	Customer	End Segment	# of LOI / PO	Application	Customer Location
1	Global Tier 1 supplier to Aircraft OEMs - 1	Aerospace	4	Cargo systems	India (Deemed Exports)
2	Global Tier 1 supplier to Aircraft OEMs - 2		2	Cargo systems	USA
3	Global Civil Security and Defence OEM		2	Aerostructures / Structural	EU, USA
4	Global North American Aircraft OEM		3	Aerostructures	USA
5	Tier 1 Supplier to Defence Sector	Defence	3	Engine Casings	India
6	Tier 1 Supplier to Defence Sector		3	Structural parts (Radar)	India
7	Tier 1 Supplier to Defence Sector		1	Mechanical assembly (Telescope)	India
8	Global Recreational Vehicle OEM	Off-Road	6	Engine, Suspension, Transmission	USA
9	Vehicle and powertrain development service provider		5	Engine	India
10	Global Tractor and CV OEM	Agriculture	1	Engine	EU
11	Manufacturer of precision components		1	Hydraulic Pump	India
12	Global trading house		1	Common Rail	Asia
13	Indian arm of a Global Tier 1 supplier	Agriculture / Others	2	Engine	India
14	Global engine manufacturer - 1	Others	1	E&CG (Stationary Engines)	India
15	Global engine manufacturer - 2		2	E&CG (Stationary Engines)	India
16	Indian arm of Global engine-based fuel and air management systems company		3	E&CG (Stationary Engines)	India
17	Manufacturer of precision components for Automobile, Aerospace, Medical etc.		1	Medical Equipment	India
18	Indian arm of Global manufacturing and supply chain management company		2	Power Transmission, Railways	India
19	Manufacturer of metal castings and fabricated components		1	Others	India
20	Global manufacturer of power transmission solutions		1	Bicycles	Canada
21	European OEM of earth moving / material handling equipment		1	E&CG (Stationary Engines)	EU

Design and Engineering, Machine Building and Automation Capabilities

We are engineering-led in our capabilities, with integrated operations across the product cycle. As of July 31, 2021, we had a team of 201 personnel working in our design, engineering, machine building, automation and technical support divisions to cater to the different product requirements specified by our customers.

Design and Engineering Capabilities

We possess design and engineering capabilities from product conceptualisation to execution.

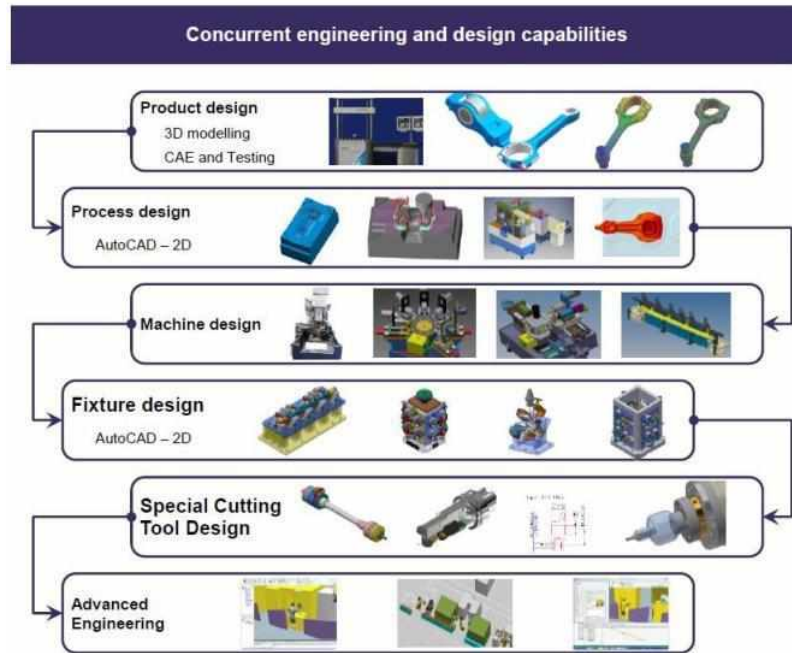

Product Design, Validation and Testing: Increasingly, requests for quotations for supply of new components include only a statement of requirements instead of technical specifications or drawings.

We use our computer aided design tools to convert statements of requirements into specifications and three-dimensional models. The forging designs are validated using metal flow simulation and stress analysis software, enabling design engineers to optimise the design and process parameters to ensure higher operational efficiency and productivity. The metal flow simulation process also optimises raw material usage. We also conduct finite element analysis to identify critical features of a product to eliminate potential design failure areas. If required, the designs then undergo fatigue testing to evaluate their sturdiness. These designs generated by us are then sent for customer approvals before initiating the prototype development process. We utilise specialised software to generate the tool path and virtual measurements of the component using integrated coordinate measuring machines.

This participation in the design of components solidifies our position as the customer's preferred supplier and provides a significant competitive advantage.

Process Design: Our process design follows a well-structured process comprising die and forging tool design, forging simulation and optimisation, tool path generation and die milling, forging and machining and related documentation. The process is designed to optimise performance while ensuring production of complex components to the required designs and specifications.

Machine Design: Our machine design capabilities have evolved from manual and low throughput machines to fully automated and high-capacity production lines. We have designed machines such as automated cells, four and eight station SPMs, double disc grinding machines, internal grinding machines and vertical honing machines. As an example, our eight station special purpose machines are suited for mass production of components which involve operations such as turning, boring, facing, drilling, reaming and tapping.

Fixture Design: We design and manufacture jigs and fixtures which are used in production, inspection and assembly. With processes and resources such as parametric three-dimensional modelling, standard part libraries, mistake proofing, quick setup changes, multi-model adoption and integration with machining and automation design, we seek to prevent incorrect assemblies, detect errors at various stages of the production process, improve equipment uptime and reduce maintenance costs. Using iLOGIC technology, we are able to automate variations to our designs and configure our products more easily with new assembly functions, resulting in quicker design time. For instance, the design time using iLOGIC technology is generally two to three days shorter than the regular design time for our key automotive sector products.

Cutting Tool Design: We design and develop cutting tools and holders for optimisation of process and cost per component. These tools are then integrated with machines and fixtures and can be standardised across product families.

Advanced Engineering: Our advanced engineering capabilities include ergonomic analysis, robotics and automation design to reduce air-cutting time as well as for product validation checks. With advanced engineering capabilities, we are able to improve the throughput of the production line and determine the size of buffers and the number of machines the intended throughput

requires. We are also able to investigate how failures affect the throughput and the utilisation of the machines.

Robot simulation and machine kinematics simulation optimise cycle times through time-based simulations. This allows us to plan our personnel needs more efficiently, manage the cost of investment in production lines and optimise the performance of existing production systems.

Machine Building Capabilities

We possess machine building capabilities with special purpose machines being manufactured in-house. Our Company has a dedicated facility in Bengaluru for machine building and machine design with 56 personnel employed as of July 31, 2021.

Special purpose machines are customised machines deployed to automate industrial processes to ensure high productivity. Designed to operate for 24 hours a day with minimum supervision, special purpose machines are mostly product-specific and need to be designed and developed as per individual requirements. The capability to produce special purpose machines requires design expertise, industry knowledge and technical know-how. While competition is high in the manufacture of less complex special purpose machines, machines requiring high precision and design standards are produced by relatively few manufacturers in India. (Source: the CRISIL Report, page 156).

Our CNC SPMs are designed and developed in-house, including electrical components assembly, spindle assembly, laser calibration, and integration with automation, trials and prove-outs, save for standard parts such as controllers, ball screws, castings and machine covers. This provides us with quality, operating efficiency and cost advantages, and also enables us to respond quickly to any change in specifications by our customers, thereby ensuring a shorter supply time. As of July 31, 2021, we had more than 900 computer numerical control special purpose machines built in-house, and we manufactured 65 machines during Fiscal 2021. We have also manufactured specific special purpose machines in India for use by Sansera Sweden.

Details of our specific complex special purpose machines are as follows:

Automated Cells: We have designed and built several automated cells, some of which consist of 10 special purpose machines performing 10 different operations, and are being utilised towards bolt hole machining operations for connecting rods. An overhead gantry is used for transferring pallets between each station. Salient features include industry 4.0 capabilities wherein machines are connected on the network from which they can be accessed remotely for data acquisition and maintenance, and with a requirement of only two operators for the entire automated cell of 10 special purpose machines. We have extended the same concept towards our suspension component production lines, thus establishing fungibility of capex over multiple product segments.

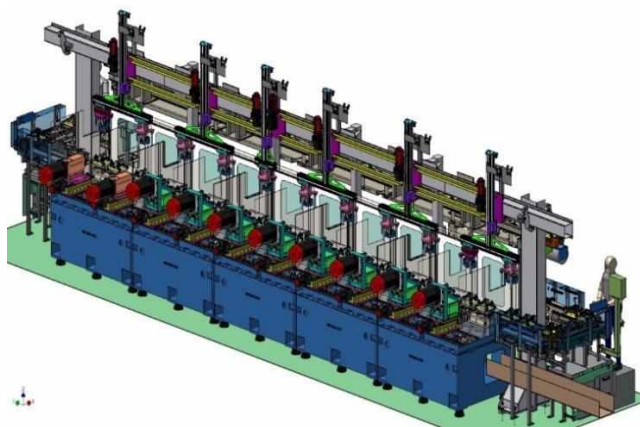

Four-Station Special Purpose Machines: Our four-station special purpose machines result in high part quality as all pre-machining operations (such as pin hole drilling and pre-finish boring of pin hole for bush fitting and crankpin pre-boring) are combined in single special purpose machines and single clamping.

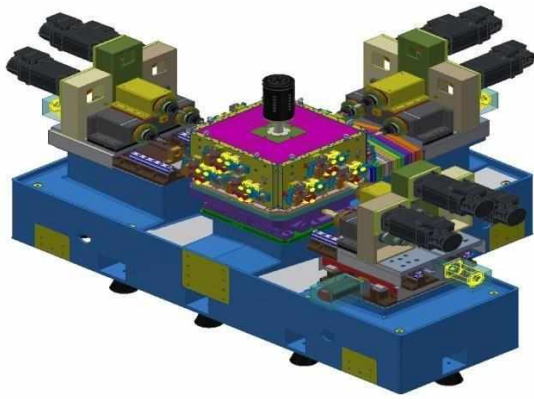

Double Disc Grinding Machines: Salient features of these machines include high speed and high precision grinding with part inspection features. Components for a range of engine categories can be grinded using these machines. The components are fed through a guided chamber in a rotating carrier plate.

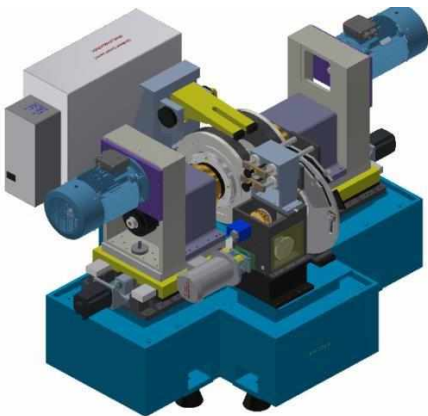

Vertical Honing Machines: We design and manufacture our four-station honing machines which have multiple part honing capabilities with a range of honing diameters. These machines have a servo actuated tool expansion. These machines help us to achieve precision on cylindricity tolerance.

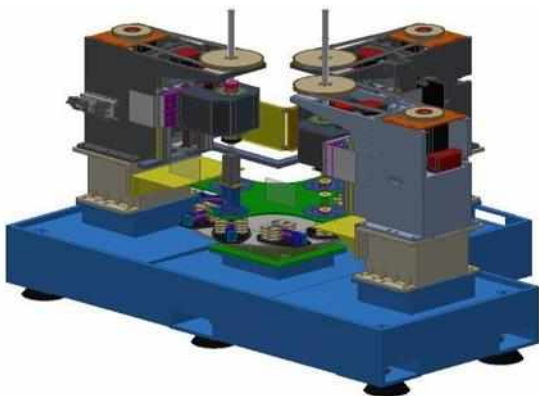

Internal Grinding Machines: We have designed and built high precision ID grinding machine in house. The salient features of this machine include high speed and high precision grinding with part inspection features. This machine can grind components for a range of categories. To ensure a very high degree of repeatability, this machine is equipped with precision work head with axis servo motor driven system and linear scale for size control axis. Development of this machine has helped us in reducing our dependence on expensive and high lead time imported internal grinding machines.

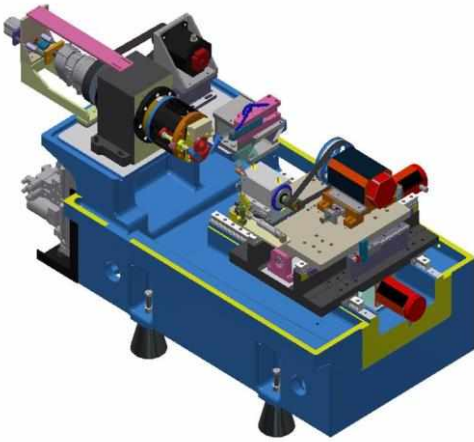

Automation Capabilities

Our Company’s automation division included a team of 27 personnel as of July 31, 2021 who work concurrently with machine and fixture design and have implemented multiple automation projects intended to increase our productivity and control labour costs. We focus on operational efficiency through the implementation of multiple automation projects for higher productivity and cost control. Key automation projects implemented in-house include assembly automation, automated inspection cells, pick and place systems, material handling gantries and machine tending robots.

Details of our key automation projects are as follows:

Automated Fracture and Bolt Assembly Cells: Our automated assembly cells for connecting rods perform six operations and two inspection processes via the use of five robots. The operations include pin bore inspection, laser grooving, fracture of crank-end, brushing, air-blast cleaning, bolt insertion and torque and chip off inspection. The assembly cell with the abovementioned operations has a “takt time” (which refers to the average time between the start of production of one piece and the start of production of the next piece) of 15 seconds per piece. These automated assembly cells are configured with SCADA (Supervisory Control and Data Acquisition) control system architecture.

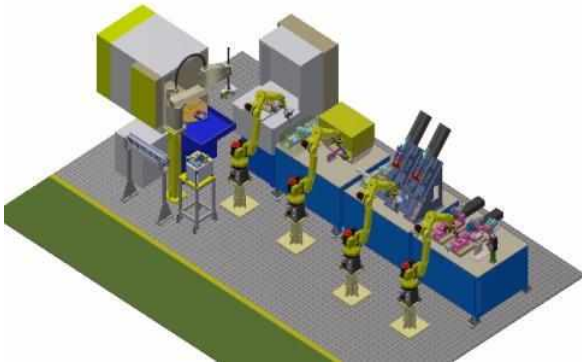

Robotic Final Inspection Cells: Our automated final inspection cell has two robots for measuring 14 critical dimensional parameters and differential weight between the pieces. It is programmed with laser marking and grade segregation abilities. The automated final inspection cell has a takt time of 12 seconds per piece.

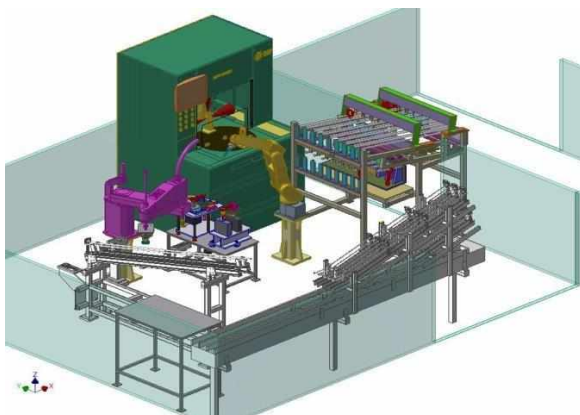

We have leveraged our design and engineering, machine building and automation capabilities as summarised above in our existing production facilities to stay competitive. As an example, the following chart shows the evolution of our fractured-split connecting rod lines over six generations and eight years:

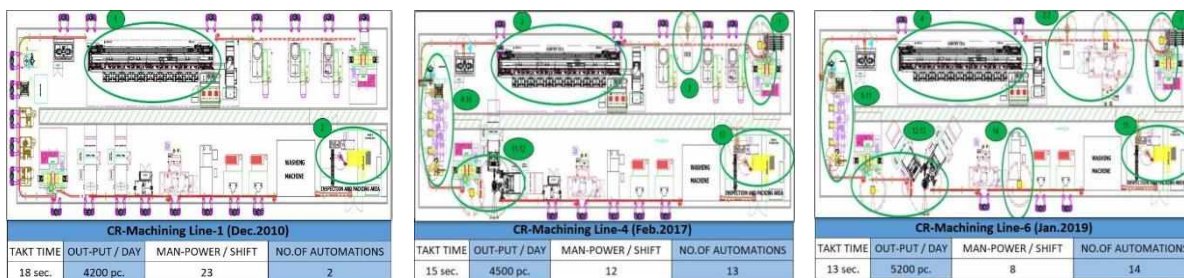

As indicated above, we have progressively been able to reduce takt time and increase productivity by increasing the number of automations. Adopting a similar approach, we have designed and built automated gantry lines for our suspension component, stem comp, wherein, apart from multiple machining operations, welding operation automation has also been incorporated. This has helped us to improve productivity and reduce manpower requirements significantly. We now plan to deploy these capabilities across our manufacturing lines for existing and new products.

Manufacturing

Facilities

As of July 31, 2021, we had 16 manufacturing facilities, 15 of which are in India in the states of Karnataka (Bengaluru, Bidadi and Tumkur), Haryana (Manesar), Maharashtra (Chakan), Uttarakhand (Pantnagar) and Gujarat (Mehsana)—and one is in Trollhättan, Sweden, which is operated by Sansera Sweden. Of our 15 manufacturing facilities in India, Fitwel operates two manufacturing facilities in Tumkur. The map below shows the locations of our manufacturing facilities.

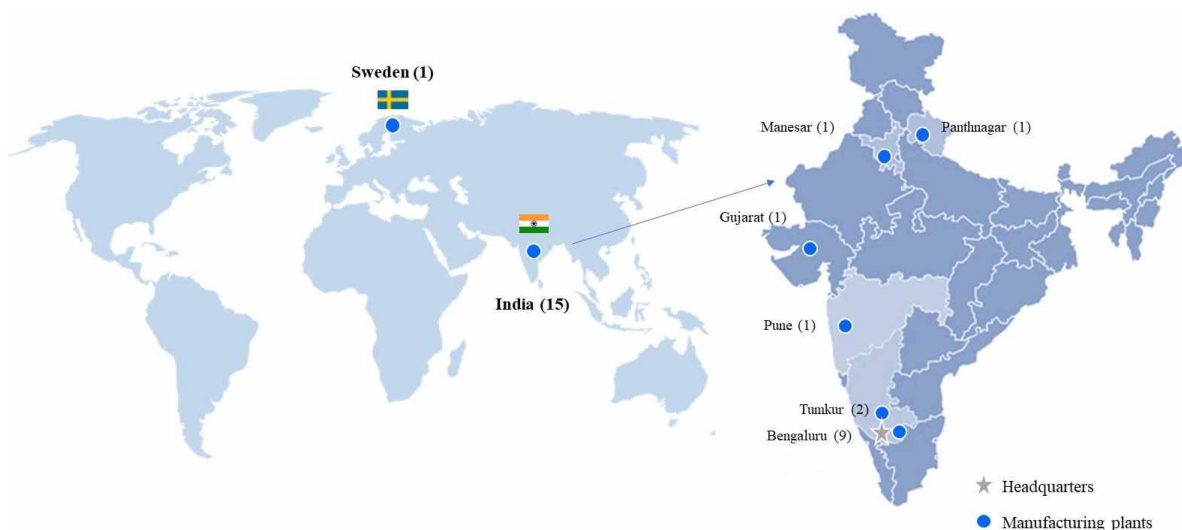

Our plant configurations are flexible, allowing us to move our machinery from one location to another to interchange capacity and product mix. We can also shift production lines between certain products based on customer and operational requirements, thereby enhancing our machine productivity. All of our automotive components are capable of being designed, engineered and manufactured in at least two of our manufacturing facilities (excluding the facility in Trollhättan, Sweden).

All our facilities in India are ordinarily operated around the clock for six days a week (closed on Sundays), except on national holidays.

Details of our manufacturing facilities are as follows:

Manufacturing Facility ⁽¹⁾	Key Products	Facilities
Plant 1	Rocker arm, crankshaft assembly	Machining and assembly
Plant 2	Rocker arm, connecting rod, rocker shaft, gear shifter fork, drive train and chassis components	Machining, assembly and heat treatment, metallurgy and metrology laboratory, and die milling

Manufacturing Facility⁽¹⁾	Key Products	Facilities
Plant 3	Rocker arm, crankshaft, balancer shaft, integral crankshaft and arm relay	Machining and assembly
Plant 4	Rocker arm, connecting rod and piston assembly	Machining, heat treatment, and assembly
Plant 5	Rocker arm, crankshaft, connecting rod, integral crankshaft	Forging and heat treatment, machining and assembly and tool room
Plant 6	Rocker arm, connecting rod, crankshaft, gear shifter fork, sprocket	Forging and tool room, machining and heat treatment, and chrome plating and assembly
Plant 7	Connecting rod	Engineering, testing, forging and tool room, and machining and assembly
Plant 9	Aerospace components	Machining and assembly
Plant 10	Machine building	Part machining, assembly, painting and automation
Plant 11	Connecting rod, stem comp, aluminium forged parts, and integral crankshaft	Forging, machining, robotic welding, assembly and paint shop
Plant 12	Rocker arm, connecting rod, gear shifter fork, crankshaft, drive train and chassis components	Forging press, drop and hydraulic hammer, and heat treatment.
Plant 14		
Plant 15	Stem comp	Welding, assembly and painting
Fitwel - Plant 1	Rocker arm, connecting rod, crankshaft, gear shifter fork, camshaft, link, lever, barrel, rotor and pump housing	Forging press, drop hammer, heat treatment, friction screw press and tool room
Fitwel - Plant 2		Machining
Sansera Sweden Plant	Connecting rod	Machining

Note:

(1) Plant 8 is used for training, quality systems and new product development and is not used for manufacturing. Our Company does not have a Plant 13.

For more details on our manufacturing facilities, see “-Immovable Properties” on page 181.

Planned New Manufacturing Facilities

We plan to construct a new greenfield manufacturing facility in Bangalore dedicated to aerospace and defence. This facility is planned to have a built up area of 13,020 square metres compared to a built up area of 4,000 square metres for our current facility for aerospace, Plant 9. We expect the facility to be commissioned during Fiscal 2023. The estimated cost to build the new plant is ₹ 200 million. Once this new facility is built, we will move the machinery currently in Plant 9 to the new plant and close Plant 9.

Fitwel, our Company’s subsidiary, has leased additional premises in Tumkur, Karnataka (which we call Fitwel Plant 3) for expansion of its business. We expect the facility to be commissioned during Fiscal 2022.

Manufacturing Processes

Set forth below is a chart and description of the key manufacturing processes for precision forged and machined components at our manufacturing facilities:

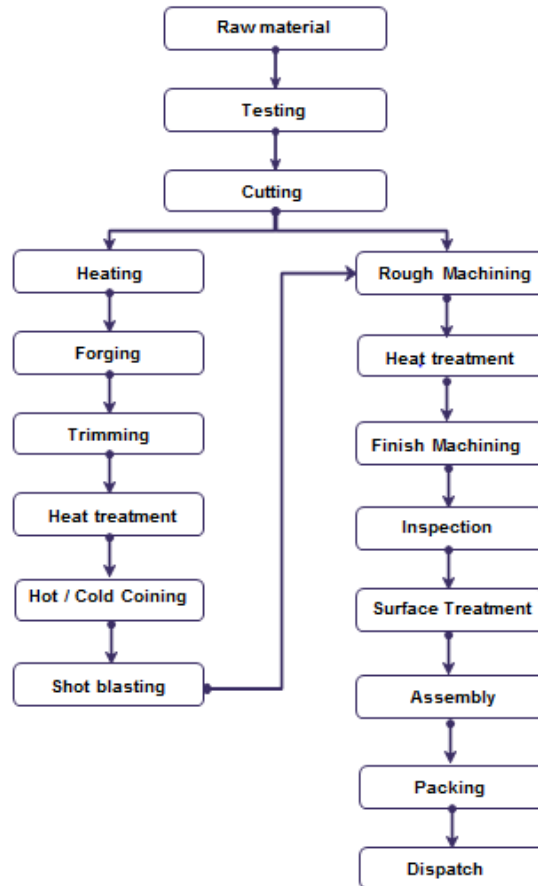

Forging: The manufacturing process typically starts with steel bars (raw material) that are cut into smaller billets by the shearing or sawing process. The billets are heated to stipulated temperatures and then subjected to a process of forging where the metal is pressed, pounded or squeezed under high pressure resulting in high-strength parts with the required shape and size.

Heat Treatment: The forged components are subjected to heat treatment to achieve the required specifications for microstructure and hardness, among others. Our heat treatment facilities include various types of furnaces such as sealed quench furnaces and other batch and continuous furnace lines. Certain parts are also subjected to heat treatment during the process of machining to achieve a more specific microstructure, case depth and hardness.

Shot Blasting: The forgings are then subjected to further operations such as shot blasting, a surface treatment process in which high velocity steel abrasive shots are directed in a controlled manner onto the surface that needs to be treated. Shot blasting is a method through which it is possible to obtain excellent cleaning and surface preparation for subsequent finishing operations.

Machining: Machining refers to the conversion of raw forging into a finished component with exact specifications in relation to size, shape and other performance parameters. Machining operations are usually divided into the two phases, distinguished by purpose and cutting conditions:

- **Roughing:** Roughing is used to remove large amounts of material from the starting work-part (typically a forging) as rapidly as possible, in order to produce a shape close to the desired form but leaving some material on the piece for a subsequent finishing operation.
- **Finishing:** Finishing is used to complete the part and achieve the final dimensions, tolerance and surface finish.

Some of our key machining processes are milling, turning, drilling, slitting, reaming and boring, tapping, honing and grinding (including the inside diameter, outside diameter, double disc, surface and profile grinding).

Machining operations are performed on special purpose machines, which typically are computer numerically controlled. In addition to designing and building these special purpose machines in-house, we also make our own dies (for forgings), jigs (for holding tools in the machine) and fixtures (for holding the work-part in the machine or for inspection) during machining operations.

Surface Treatment: Machined parts are further subjected to specific surface treatment such as hard chrome plating, diamond-like carbon coating and phosphating to provide high performance product life, wear resistance, better surface finish and corrosion resistance.

Testing and Validation: Our in-house capabilities in product testing and validation enable us to test and validate our products

in conformity with customer requirements. This ensures product reliability, reduces the product development cycle time to meet customer's requirements and helps reduce manufacturing throughput time.

Quality Assurance and Quality Control

In the precision components manufacturing industry, adherence to quality standards is a critical factor as any defect in any of the products manufactured by us, or failure to comply with the design specifications of our customers, may lead to cancellations of purchase orders placed by our customers and loss of reputation. In order to maintain the quality standards and comply with the design specifications our customers, we follow a stringent quality control mechanism. At each stage of the manufacturing process, the components are examined by our operators to ensure there is no defect from the previous stage operator. Separately, representatives of our customers regularly inspect our manufacturing facilities and manufacturing processes. We also have a separate team of engineers responsible for quality assurance. For further details, see "*Risk Factors - We are subject to strict performance requirements, including, but not limited to, quality, delivery and development activities, and any failure by us to comply with these performance requirements may lead to the cancellation of existing and future orders, recalls or warranty and liability claims*" on page 30.

Most of our manufacturing facilities in India have been certified for international standards of quality management systems such as International Automotive Task Force ("**IATF**") 16949:2016 and BS EN 9100:2016 (technically equivalent to AS9100D), environmental management system standard ISO14001:2015 as well as occupational health and safety management system standards ISO 45001:2018.

All our manufacturing facilities except Plants 9, 10 and 15 (Plant 15 has successfully completed the audits and is awaiting its certificate) are certified for automotive sector quality management systems as per the IATF requirement. We have AS 9100D and BS EN ISO 9001:2015 certifications by UKAS Management Systems under the Aerospace Sector Certification Scheme for current international standards of quality management systems for our aerospace component manufacturing facility (Plant 9).

Sales and Marketing

Customer Acquisition Process

In the precision components industry, OEMs tend to have extensive and detailed vendor approval processes which typically take 18 to 24 months. While each OEM has its own approval process, the typical sequence of activities for new vendor approvals is as follows:

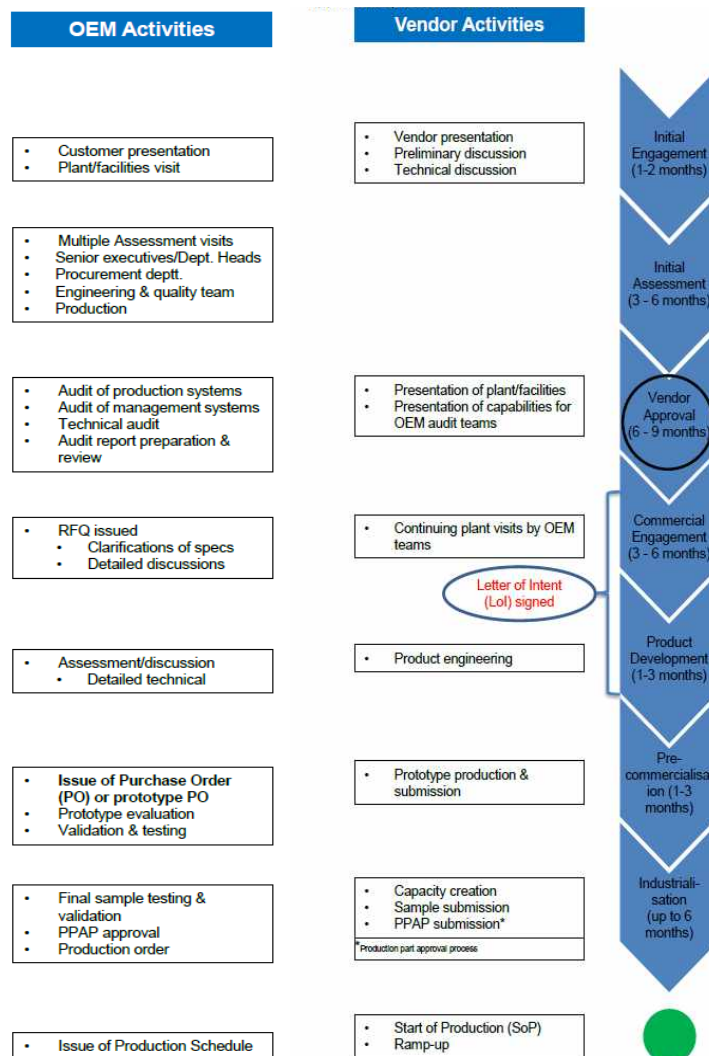

Given the time and effort involved in the approval process as indicated above, OEMs typically do not switch vendors unless there are specific quality and cost issues.

Our customers at times also request us to partner with their own development teams throughout a product cycle, which involves design, engineering and product development. Accordingly, our engineers and sales team work on-site at the customers' location with their in-house engineering and design teams to develop customised solutions, which in turn allows us to maximise our sales opportunities. We believe such arrangements give us the opportunity to embed our products into our customers' expansion and development plans.

Sales and Marketing Team

Our sales and marketing team focuses on developing customer relationships, acquiring new contracts for development and manufacturing, identifying new customers and generating business opportunities. We focus on strategically aligning ourselves with customers to create long-term relationships after the initial sale.

Customers

Our OEM customers include some of the largest Indian and global OEMs. During Fiscal 2021, we had a diverse customer base in India and 24 other countries across North America, Latin America, Europe and Asia, and a consistent track record of adding to our total numbers of customers over the years as indicated below:

	Total Number of Customers ⁽¹⁾		
	Fiscal 2021	Fiscal 2020	Fiscal 2019
Automotive	47	43	41
Non-Automotive	28	28	26
Total⁽²⁾	71	68	64

Notes:

(1) Customers exclude Tier 1 and Tier 2 suppliers supplying to the same OEM customer.

(2) Total is computed post elimination of common customers between automotive and non-automotive segments.

Our key customers across the verticals we supply to are as follows:

Vertical / Sector	Customers
Automotive:	
Two-wheelers	Indian: Bajaj; HMTI; TVS Motor; Royal Enfield; Yamaha Motor India; and Hero MotoCorp. Global: KTM; Triumph; a U.S. 2W OEM; a German 2W OEM; a European 2W OEM; and a Japanese 2W OEM.
Passenger vehicles	Indian: Maruti Suzuki; Honda Cars India; Toyota Kirloskar; and Volkswagen India. Global: Stellantis N.V. (formerly Fiat Chrysler Automobiles); a leading North American PV OEM; a global Tier 1 supplier; and a premium European OEM.
Commercial vehicles	Indian: a leading Indian OEM; Daimler India Commercial Vehicles Private Limited and Engineered Components and Systems India. Global: a leading Swedish OEM; CNH; leading European OEMs; a leading Japanese OEM; a leading U.S. OEM; and global suppliers of braking systems.
Non-Automotive:	
Aerospace	Indian: a leading Indian Tier 1 supplier; and AAI. Global: Collins Aerospace; SAAB; a global North American aircraft OEM; and global Tier 1 suppliers.
Off-road	Global: Polaris.
Agriculture	Indian: Indian arms of a global supplier of fuel injection systems; and the Indian arm of a global engine-based fuel and air management systems manufacturer
Others	Indian: JCB, the Indian arm of a global manufacturer of engines; the Indian arm of a global manufacturing and supply chain management company; and a subsidiary of a leading global power tools manufacturer. Global: a Tier 1 supplier to a global marine engine manufacturer.

Our OEM customers typically have stringent, time-consuming selection, inspection and review procedures for procurement of components from manufacturers. These procedures include review of the manufacturer's expertise, available manufacturing facilities, processes, financial capabilities and logistical capabilities. For further details, see “- Customer Acquisition Process” on page 176.

For details relating to our relationship with key customers and break up of our key customers in various segments in the automotive and the non-automotive sectors, please see “-Our Strengths – Long-standing relationships with well-known Indian and global OEM customers” on page 152.

Customer Agreements

For our domestic customers, we do not generally have firm commitment or long-term purchase agreements with most of our customers and instead rely on purchase orders issued by our customers from time to time. For our export customers, we enter into various purchase and supply agreements. The components are supplied by us under various purchase orders issued by the customers from time to time, under the terms of the master purchase or supply agreement. For further details, see “Risk Factors – We do not have firm commitment long-term supply agreements with our customers. If our customers choose not to source their requirements from us, there may be a material adverse effect on our business and results of operations” on page 24.

The purchase orders issued by customers specify the type of components, the quantity and the cost for each batch of orders placed. Most of our customers provide us with forecasts of order volumes, generally firm for the first month, and a tentative delivery schedule for the following months, as well as annual sales projections that help us estimate the production requirement and capital expenditure for that particular product or business line for facilitating our resource planning. When actual production volumes differ significantly from our estimates, we generally seek to make up any shortfalls through new orders, either with existing or with new customers, which may or may not materialise.

The purchase orders are typically subject to conditions such as ensuring that all products delivered to the customer have been inspected and will be safe for use, that orders will be fulfilled according to predetermined delivery schedules and that all products will be built to customer specifications. Some of our customers, under their respective purchase or supply contracts, have the right to check and verify our relevant manufacturing systems processes, which may include inspection of the manufacturing facilities, review of the manufacturing processes and review of the raw materials. Further our purchase or supply contracts contain a warranty provision which warrants conformity of products to specifications, drawings, samples or descriptions furnished by the customers and further warrants that products delivered will be merchantable, of good material and workmanship and free from defects.

While in practice we have passed the increase in the cost of raw materials onto our domestic customers, there is usually a gap in time between the date of procurement of those raw materials and the date on which we can reset the component prices for our customers so as to account for the increase in the prices of such raw materials. In addition, we may not be able to pass raw material price increases to all our customers as our ability to adjust pricing terms with customers varies based on our specific customer relationships, market practice with respect to the particular raw material or component and other factors such as raw material content and whether medium-term price fluctuations have been factored into our component prices at the time of price finalisation. As a result, for some of our export customers, we may in some instances bear the risk of any price increases that occur.

Raw Materials and Suppliers

Our primary raw materials include (i) alloy steel rounds bars and non-ferrous alloys such as aluminium and titanium, and (ii)

assembled components, such as roller bearings, screws, crank pins, bolts, bushes and sintered tips.

We procure raw materials from our suppliers based on purchase orders and we do not have any purchase agreements or firm commitments executed with them. Pursuant to the terms of our purchase orders, we reserve the right to reject defective materials, and any warranty claims accepted by us for defective materials supplied by our suppliers are passed onto such suppliers. We primarily purchase raw materials back-to-back and in line with the terms and prices that are agreed with our customers, either from suppliers stipulated by our customers or those suggested by us and approved by our customers. We procure from multiple suppliers with whom we have long-term relationships to ensure timely availability of raw materials of the desired quality and quantity. We have a diversified supplier base to reduce supplier concentration risk. For further details, see “*Risk Factors – We depend on third parties with whom we do not have long-term supply contracts for the supply of raw materials. A loss of suppliers or interruptions in the delivery of raw materials or volatility in the prices of raw materials on which we rely may have a material adverse effect on our business and results of operations*” on page 34.

Our suppliers undergo a qualification process and performance rating to ensure that the supplied raw materials are of satisfactory quality. We select our suppliers and sub-contractors based on their performance and delivery and quality rating.

Energy and Water

Our manufacturing processes require an uninterrupted and constant voltage power to ensure that the products are of high quality and also to increase the productivity and lifetime of our machines and equipment. We make arrangements for power purchase from local utilities, independent renewable power producers as well as captive power generation through rooftop solar and generator sets in all our manufacturing facilities. We have invested in Cleanmax Vega Power LLP (a power producer) and entered into an energy supply agreement in Fiscal 2020 for a period of 25 years with a lock in period of five years. Pursuant to such energy supply agreement, we have committed to purchase at least 51% of the total power produced by Cleanmax Vega Power LLP. We are also able to conserve energy through our in-house development of computer numerical control special purpose machines, which are built with optimal energy usage in mind.

Our manufacturing processes require water consumption although they are not water intensive. The requirement for water is met primarily through outside resources, or through local utility companies. In a few of our manufacturing facilities, the water requirement is met through our own bore wells. We undertake water conservation measures on an ongoing basis and reuse water in order to reduce wastage.

For further details, see “*Risk Factors – We have power and water requirements and any disruption to our power or water sources could increase our production costs*” on page 43.

Transportation

Our products are typically shipped to our OEM customers. The mode of transportation for a particular shipment is dependent on the urgency, size and value of the order. Our domestic operations use a number of different modes of third-party transportation, including road, air and rail. We manage the transportation requirements for such domestic or inbound freight directly. Where a shipment is outbound overseas, we use a number of different modes of third-party transportation, including road, air and sea. We also utilise third party freight forwarders who contract with the relevant ocean carriers and airlines on our behalf and engage third party logistics services providers to provide support on our transportation requirements. These third-party service providers are responsible for ensuring our transportation rates are competitive and that our transportation carriers are performing as required. For further details, see “*Risk Factors – We are dependent on third parties for the transportation and timely delivery of our products to customers*” on page 34.

Human Resources

We are focused on developing the expertise, skill sets and know-how of our employees. Our personnel policies are aimed at recruiting talented individuals and promoting the development of their skills, including through in-house as well as external training programmes.

In order to retain flexibility and control costs, we appoint independent contractors who in turn engage on-site contract labour for performance of certain of our operations in India. For more details, see “*Risk Factors-We are dependent on contract labour and if we are unable to obtain the services of skilled and unskilled workmen at reasonable rates it will have an adverse effect on our business and results of operations. In addition, even if we have already paid the independent contractors who directly engage these workmen, we may be responsible for paying the wages of such workers if the independent contractors default on their obligations to them, and such obligations could have an adverse effect on our cash flows until such amount is recovered from the independent contractors and on our results of operations and financial condition in the event we are unable to recover such amount from the independent contractors*” on page 33.

The following table sets forth the breakdown of our workforce as of July 31, 2021:

Particulars	Number
Managerial Staff	287
Engineers	490
Executives	92
Trainee Engineers	46
Assistants	58
Total Staff (A)	973
Confirmed Employees	1,259
Trainees and Apprentices	1,641
Total Associates (B)	2,900
Total Employees (A+B)	3,873
Contract Workmen (C)	4,533
Total (A+B+C)	8,406

As of July 31, 2021, 1,174 of our employees were members of labour unions. We have entered into labour union agreements involving, among others, revised wage structures, ex-gratia payments, attendance bonuses and the provision of or enhancement of insurance policies. For further details, see “*Risk Factors – Our employees are members of unions and we may be subject to industrial unrest, slowdowns and increased wage costs, which may adversely affect our business and results of operations*” on page 28.

Health, Employee Safety and Environment

We endeavour to adhere to laws and regulations relating to protection of health, employee safety and the environment. We carry out our activities while following appropriate standards of work safety and our working conditions seek to promote a healthy and safe work environment. We have an employee health and safety policy to promote workplace health and safety and minimise the risk of accidents at our facilities.

We have taken initiatives to reduce the risk of accidents and prevent environmental pollution at our facilities, including: (i) ensuring that plant employee safety manuals covering employee safety and environmental procedures are in place and that plant level hazard identification and risk assessments are periodically carried out; (ii) providing training and awareness programs on employee safety and environment to all employees, including training on machines and other operations at shop floors, and the use of first aid and other procedures to deal with emergencies; (iii) implementing regular employee safety audits, management review meetings and periodic employee safety meetings; and (iv) conducting periodic emergency mock drills in our plants.

We have experienced work-related injuries, such as burn injuries sustained by two contract workers pursuant to a fire accident at Plant 12, and a cut and crush injury sustained by a contract worker while removing scrap struck at the hydraulic cylinder area of a compactor machine at Plant 9. After each incident, we conducted a thorough internal investigation as to the reasons that the incident occurred and implemented policy and process changes aimed at minimising the risk of similar future incidents. For further details, see “*Outstanding Litigation and Material Development – Litigation involving our Company – Litigation against our Company*” on page 316.

In addition, we have implemented initiatives to reduce the environmental impact of our operations. Such initiatives include: (i) organising periodic workshops to enhance the capabilities of plant heads and their teams with respect to environment compliance management; (ii) setting up and periodically upgrading effluent and sewage treatment plants at our manufacturing facilities to treat and recycle treated wastewater; (iii) installing solar panels and sourcing power for our operations from renewable energy sources; and (iv) switching to LED lights from a conventional lighting system.

We have obtained, or are in the process of renewing, all material environmental consents and licenses from the relevant governmental agencies that are necessary for us to carry on our business. Our activities are subject to the environmental laws and regulations of India, which govern, among other things, air emissions, wastewater discharge, and handling, storage and disposal of hazardous substances and wastes. Sansera Sweden is subject to Swedish regulations relating to environmental, health and safety measures.

All our existing manufacturing facilities, except for Plants 1, 10 and 15, are certified for environmental system standard ISO 14001:2015 and for the occupational, health and safety system standard ISO 45001:2018.

We have been subject to closure orders and two demand notices for Plants 6 and 12 and one show cause notice for Plant 4 in relation to non-compliance or alleged non-compliance with environmental laws. For further details, see “*Risk Factors – Our operations are subject to environmental, health and safety laws, which could result in material liabilities in the future*” and “*Outstanding Litigation and Material Developments – Litigation involving our Company – Litigation against our Company*” on pages 31 and 316, respectively.

Intellectual Property

We rely on a combination of trademark laws, confidentiality procedures and contractual provisions to protect our intellectual property. For details of our registered trademarks, see “*Government and Other Approvals – Intellectual Property Rights*” on page 323. We cannot be certain that the steps we have taken will prevent unauthorised use of our intellectual property. For more

details, see “Risk Factors - If we fail to keep our technical knowledge confidential, it may erode our competitive advantage and have a material adverse effect on our business, financial condition, results of operations and cash flows” on page 28. We have not made any applications for registration of copyrights or patents under applicable laws.

Immovable Properties

Our Company’s Registered Office and Corporate Office is located at Plant No. 7, No. 143-A, Jigani Link Road, Bommasandra Industrial Area, Anekal Taluk, Bengaluru, Karnataka 560 105.

Details of the land on which our manufacturing facilities are located are set forth in the table below.

Manufacturing Facility	Address	Owned/ Leased (term of lease)
Plant 1	Survey No. 26/6, Village Yarandahalli, Jigani Hobli, Anekal Taluk, Bommasandra Industrial Area, Bangalore – 560099	Leased (April 15, 2019 to April 14, 2024)
Plant 2	Plot No. 260/A (P), 261/C and 262/A, Bommasandra Industrial Area, Bommasandra Village, Attibele Hobli, Anekal Taluk, Bengaluru, Karnataka	Owned
Plant 3	Plot No. 1, Bommasandra, Jigani Link Road, Industrial Area, Yarandahally Village, Jigani Hobli, Anekal Taluk, Bengaluru, Karnataka	Owned
Plant 4	Plot No. 22-23, Sector – 6, Industrial Estate, I.M.T. Manesar, Gurgaon, Haryana	Owned
Plant 5	Plot No. B-18, Chakan, MIDC, Industrial Area, within village limit of Nighoge Taluka, Khed, Pune, Maharashtra	Leased (December 10, 2004 to December 9, 2099)
Plant 6	Plot No. 18, Sector 9, SIDCUL, Integrated IE Pantnagar, Udham Singh Nagar, Uttarakhand	Leased (June 5, 2006 to June 4, 2096)
Plant 7	Plot No. 143-A, Bommasandra-Jigani Link Road Industrial Area, Kyalasanahally village, Jigani Hobli, Anekal Taluk, Bengaluru, Karnataka	Owned
Plant 9	Plot No. 125-126, 4 th Phase, Bommasandra, Jigani Link Road, Industrial Area, Yarandahalli Village, Jigani Hobli, Anekal Taluk, Bengaluru, Karnataka	Leased (May 15, 2015 to May 14, 2025)
Plant 10	Plot No. 102, Bommasandra, Jigani Link Road, Anekal Taluk, Bengaluru Urban District, Karnataka	Leased (April 1, 2021 to March 31, 2022)
Plant 11 ⁽¹⁾	Plot No. 48, Bidadi Industrial Area, Phase-II, Sector-II, Shyanumangala, Bidadi Hobli, Ramanagara Taluk, Bengaluru, Karnataka	Leased (August 8, 2014 to August 7, 2024)
Plant 12	Site No. A1, Khata No 344, Hebbagodi Village, Attibele Hobli, Anekal Taluk, Bangalore 560099, Karnataka.	Owned
	Plot No. 143, C-2, Bommasandra Industrial Area, Hebbagodi Village, Hobli, Bengaluru, Karnataka.	Owned
	Plot No. 143, B-8, Bommasandra Industrial Area, Hebbagodi Village, Hobli, Bengaluru, Karnataka.	Lease cum sale (sale deed execution is pending)
	Plot No. 143, B-8 (Part), Bommasandra Industrial Area, Hebbagodi Village, Hobli, Bengaluru, Karnataka.	Lease cum sale (sale deed execution is pending)
	Plot No. 143, C-2, Sy.No.77, Bommasandra Industrial Area, Hebbagodi Village, Hobli, Bengaluru, Karnataka	Leased (December 1, 2020 to November 30, 2023)
Plant 14	Plot No. 34, Jigani Industrial Area, II Phase, Jigani Hobli, Anekal Taluk, Bengaluru, Karnataka	Leased (December 1, 2017 to November 30, 2027)
	Plot No. 35, Jigani Industrial Area, II Phase, Jigani Hobli, Anekal Taluk, Bengaluru, Karnataka	Leased (December 1, 2017 to November 30, 2027)
	Plot No. 36, Jigani Industrial Area, II Phase, Jigani Hobli, Anekal Taluk, Bengaluru, Karnataka	Leased (December 1, 2017 to November 30, 2027)
Plant 15	Plot No. E1-E3, Mascot Industrial Park, Jadavpura Cross Road, Kadi-Vithalapur Highway, Kadi, Distt. Mehsana, Gujarat	Leased (December 1, 2018 to November 30, 2023)
Fitwel Plant 1 ⁽²⁾	Unit No. 5, KHT Complex, Antharasanahalli, Bengaluru, Karnataka	Leased
	Unit No 6, Press Line, Unit No 6 KHT Complex, Antharasanahalli Tumkur 572106	Owned
	C 11 & 12, Die & Tools, C 11, 12 KHT Complex, Antharasanahalli Tumkur 572106	Owned
	C 13, DG Room and Control Panel Room,C 13, KHT Complex, Antharasanahalli Tumkur.	Owned
	C 14, DG Room and Control Panel Room,C 14, KHT Complex, Antharasanahalli Tumkur.	Owned
	Survey no 47/1 Antharasanahalli,Tumkur 572106	Owned
	Canteen Building, Building, Land, overhead tank and a huge sump, Behind Forge Shop,Antharasanahalli,Tumkur 572106.	Owned
Fitwel Plant 2	Unit No. 11, KHT Complex, Antharasanahalli, 1 st stage, Tumkur	Owned
Sansera Sweden Plant	461 38 Trollhättan, Elektroden 4, Sweden	Leased (September 1, 2018 to August 31, 2038)

Notes:

- (1) It includes land of 60,786.60 sq.mts. allocated by Karnataka Industrial Area Development (KIADB) at Plot No. 48, 2nd Phase, Sector-2, Bidadi Industrial Area for a period of 10 years with effect from August 8, 2014 to the Company on a lease cum sale basis.
- (2) Karnataka Small State Industrial Development Corporation (KSSIDC) has allotted land measuring 4,257 sq. mt. at Unit No. 5, KHT Complex, Antharasanahalli, Tumkur, Karnataka on a lease cum sale basis for a period of four years with effect from January 8, 1987, with specified terms and conditions to be complied with by each party. Subsequently, KSSIDC failed to comply with the terms of the agreement, hence the Group retained possession of the land. Pursuant to the communications with the KSSIDC, the Group has paid an amount of ₹ 2.01 million as consideration for the

land, which has been capitalised. As at the balance sheet date, negotiations are in progress and the Group awaits the final approval of KSSIDC with respect to the registration of the land in the name of the Fitwel.

Other properties that our Company owns or leases are listed below.

Use	Address	Owned/ Leased (term of lease)
Plant 8, which is used for training, quality systems and new product development	Plot No. 100, Bommasandra, Jigani Link Road, Industrial Area, Jigani Hobli, Bengaluru (Urban), Karnataka	Leased (October 17, 2012 to October 16, 2022)
Proposed additional facility for Aerospace and Defence	Sy. No. 101/3, Sy. No. 101/4 and Sy. No. 105/3, Jigani Village, Jigani Hobli, Anekal Taluk, Bangalore	Leased (October 1, 2021 to September 30, 2041)
Business development office	Office Unit No. STS- 424, 4th Floor, DLF Star Tower, Adjacent to Star Mall, NH-8, Gurugram, Haryana	Leased (June 1, 2019 to May 31, 2024)
Guest House	Apartment No. C-2301, Tower C, 23rd Floor, ARAYA, Sector 62, Gurugram (HR)	Leased (March 10, 2020 to March 09, 2022)
Warehouse	Plot no – 242, Sector 6, IMT Manesar Gurugram-122052, India	Leased (March, 1, 2021 to February 28, 2031)
Guest house	A-203 Amazon, Omaxe Revira, Distt. Udham Singh Nagar, Rudrapur, Uttarakhand 263153	Lease (September 7, 2007 to September 6, 2097)
Tenements	R-5 & F-6 (First floor) in 'D' Type of Bommasandra Industrial Area situated in Sy no. 288 of Bommasandra village, Attibele Hobli, Anekal taluk, Bangalore.	Owned
Additional land in Gujarat	Old survey number 280,281,282, New survey number 859, 860 and 863 Moje, Vittlapur, near Kadi, Taluka Mandal, Ahmedabad, Gujarat	Owned
Fitwel Plant 3	Plot No. 7, 2nd Phase, Antharasanahalli Indl Area, Thimalapura Kasaba Hobli, Tumkur-572 106	Leased (April 01, 2021 to March 31, 2024)

We have been issued notices and orders in the past in relation to matters involving our immovable properties, such as the execution of a sale deed for a plot of land our Company had leased pursuant to an agreement dated July 12, 2002. Some of these matters are currently pending. For further details, see “*Outstanding Litigation and Material Developments – Litigation involving our Company – Litigation against our Company*” on page 316.

Competition

We face competition, both domestically and internationally, in relation to specific products and our product ranges. The following table indicates our key competitors in the domestic market and the product families that they compete in.

Product family	Segment/Vertical	Key Competitors
Connecting rods	Two-wheeler	Bajaj Motors, Musashi
	Passenger vehicle	Amtek Auto, Amul Industries, Magal Tech
Rocker arms	Two-wheeler	Bajaj Motors, FIE Group
	Passenger vehicle	Micro Turner, Schaeffler India
Crankshafts	Two-wheeler	Kay Jay Forge, Laxmi-Agni
Gear shifter forks	Two-wheeler	Bajaj Motors, FIE Group
	Passenger vehicle	Kalyani Forge, Micro Turner, RICO Auto
Stem comp	Two-wheeler	Bajaj Motors, Endurance Technologies, Modern Automotive
Aerospace	Aerospace	Aeques, CIM Tools, Dynamatic, Godrej & Boyce, PMI Engineering Exports

(Source: the CRISIL Report, pages 185, 191, 194, 198, 201 and 205).

While the precision components manufacturing industry is extremely competitive, we believe that our core expertise in all aspects of design and engineering, our diversified portfolio of products, our ability to meet our customers’ varying requirements, and the long-standing relationships that we have built with well-known Indian and global OEM customers differentiate us from our competitors. We also believe that there are a number of barriers to entry into the market, including precision components manufacturing being a capital-intensive business and involving complex technology, machinery and systems.

Information Technology

Our design and engineering facilities comprise IT enabled processes such as computer aided design, computer aided manufacturing and computer aided engineering facilities and design software. We also have information technology systems that aid in design, development and prototyping, such as Autodesk, Tecnomatrix, QFORM, Minitab, Creo and Forge. We have implemented SAP platforms encompassing business functions including production, materials, finance, inventory, maintenance, and human resource management. We make efforts to consistently upgrade our systems to ensure efficiency and business continuity. We have also implemented a product lifecycle management system, which manages all our product data from the design stage to commercialisation.

Insurance

Our operations are subject to various risks inherent in the automotive and non-automotive industries as well as fire, theft, earthquake, flood acts of terrorism and other force majeure events. We maintain insurance policies for our manufacturing facilities in India and abroad, including buildings, machinery and godowns (warehouses), as well as for personal accident coverage, product liability coverage and workmen compensation. In addition, we maintain insurance policies covering directors' and officers' liability, cyber security, commercial general liability (except for aircraft products) and policies that provide coverage for risks during the shipment of products. We are not insured against consequential damages, environmental damages, terrorist acts and war related events.

We believe that our insurance coverage is in accordance with industry custom, including the terms of and the scope of the coverage provided by such insurance. However, our policies are subject to standard limitations, including with respect to the maximum amount that can be claimed. For example, in the case of business interruption, limitations apply with respect to the length of the interruption covered and the maximum amount that can be claimed. Therefore, insurance might not necessarily cover all losses incurred by us and we cannot provide any assurance that we will not incur losses or suffer claims beyond the limits of, or outside the relevant coverage of, our insurance policies. For further details on risks related to our insurance policies, see *“Risk Factors - Our insurance coverage may not be adequate to protect us against all potential losses, which may have an adverse effect on our results of operations, cash flows and financial condition”* on page 34.

Awards and Recognition

We have been recognised with numerous awards by our customers for the quality of our products. In 2021, we received “Zero Defect Supplies” and “Best Quality Supplier (Auto)” awards from Toyota Industries Engine India Pvt Ltd. In 2020, we received the “Silver Boeing Performance Excellence Award” from Boeing. In 2019, we received the “Powertrain Supplier of the Year” award from Fiat Chrysler Automobiles (now called Stellantis N.V.) and “Zero Defect Supply” Award from Toyota Kirloskar Motor. In 2018, we received Supplier Quality Award from KTM and Quality Award Gold from Bajaj. In 2017, we received the “Quality Performance Award” from Volkswagen, the “Zero Defect Supply Award” from Toyota, the “Best Quality Performance Award” from Fiat India Automobiles Private Limited and the “Delivery Performance Award” from Polaris. We received the “Supplier Quality Excellence Award” from General Motors for 2021 and 2018 for our quality performance, after having received four such consecutive awards between 2013 and 2016. In 2015, we received the “Best Express Award” from GKN Aerospace and were accredited by Fiat Chrysler Automobiles (now called Stellantis N.V.) for having “Perfect Quality” in 2013. For further details, see *“History and Certain Corporate Matters – Awards, accreditations, and recognitions received by our Company”* on page 190.

Corporate Social Responsibility

We seek to be a socially responsible corporation and we believe that CSR is an integral part of our operations. To this end, we established the Sansera Foundation in Bengaluru in 2007 to spearhead our CSR efforts. The Sansera Foundation is focused on demonstrating care for the community through three broad areas, namely (i) education and skill development, (ii) health and wellness and (iii) environmental sustainability, energy and water conservation. We have given ₹ 20.32 million, ₹ 27.50 million and ₹ 14.25 million in Fiscals 2021, 2020 and 2019, respectively, to the Sansera Foundation.

The Companies Act, 2013 mandates that we spend, in each fiscal year, at least 2% of our average net profits during the three immediately preceding fiscal years on CSR activities. We did not meet the required minimum expenditure towards CSR activities for Fiscals 2021, 2020 (on an accumulative basis) and 2019. For details, see *“Risk Factors-We did not meet the required minimum expenditure towards corporate social responsibility (“CSR”) activities under the Companies Act, 2013 for Fiscals 2021, 2020 and 2019 and we may be subject to penalties”* on page 38.

Recent Developments – Effects of COVID-19

For information on the effects of COVID-19 on our business, see *“Risk Factors – The COVID-19 pandemic has had, and we expect it to continue to have, a material adverse effect on our business, financial condition, results of operations and cash flows”* and *“Management’s Discussion and Analysis of Financial Condition and Results of Operations – Significant Factors Affecting our Results of Operations – Effects of COVID-19”* on pages 22 and 283, respectively.

KEY REGULATIONS AND POLICIES

The following description is a summary of certain sector specific laws currently in force in India, which are applicable to our Company. The information detailed in this section has been obtained from publications available in the public domain. The regulations set out below are not exhaustive and are only intended to provide general information to the investors and are neither designed nor intended to be a substitute for professional legal advice. The statements below are based on the current provisions of Indian law, and the judicial and administrative interpretation thereof, which are subject to change or modifications by subsequent legislative, regulatory, administrative or judicial decisions.

For details of regulatory approvals obtained by us in compliance with the applicable regulations, see “Government and Other Approvals” on page 321.

Regulations applicable to the production and manufacturing sector

Industries (Development and Regulation) Act, 1951, as amended (“IDR Act”)

The IDR Act has been liberalized under the New Industrial Policy dated July 24, 1991 and all industrial undertakings are exempt from licensing except for certain industries, including, among others, all types of electronic aerospace, defence equipment, ships and other vessels drawn by power. The IDR Act is administered by the Ministry of Industries and Commerce through the DPIIT. The main objectives of the IDR Act is to empower the Government to take necessary steps for the development of industries; to regulate the pattern and direction of industrial development; and to control the activities, performance and results of industrial undertakings in the public interest. The DPIIT is responsible for formulation and implementation of promotional and developmental measures for growth of the industrial sector.

The Legal Metrology Act, 2009 (the “Metrology Act”)

The Metrology Act has replaced the Standards of Weights and Measures Act, 1976 and the Standards of Weight & Measurement (Enforcement) Act, 1985. The Metrology Act provides for establishment and enforcement of standards of weights and measures and for regulation of trade and commerce in weights, measures and other goods which are sold or distributed by weight, measure, or number. The key features of the Metrology Act include appointment of government-approved test centres for verification of weights and measures, allowing companies to authorize any of its directors to be responsible to ensure that no offence is committed by a company under the Metrology Act and penalties for violation of the provisions of the Metrology Act.

Environmental laws

The Environment Protection Act, 1986 (the “Environment Protection Act”)

The Environment Protection Act was enacted to act as an “umbrella” legislation designed to provide a framework for coordination of the activities of various central and state authorities established under previous laws. The Environment Protection Act authorises the Central Government to protect and improve environment quality, control, and reduce pollution. The draft Environment (Protection) Amendment Rules, 2020 provide for regulations on use of membrane based water purification system which, if passed, shall be applicable to all filtration based purification or wastewater treatment system, where polymer based membrane is used and discarded at the end of its life.

Air (Prevention and Control of Pollution) Act, 1981 (the “Air Act”)

The Air Act was enacted and designed for the prevention, control and abatement of air pollution and establishes Central and State pollution control boards for the aforesaid purposes. In accordance with the provisions of the Air Act, any person establishing or operating an industrial plant in an air pollution control area must apply in a prescribed form and obtain consent from the state pollution control board prior to commencing any activity.

The Water (Prevention and Control of Pollution) Act, 1974 (the “Water Act”)

The Water Act was enacted to provide for the prevention and control of water pollution and the maintaining or restoring of wholesomeness of water. Further, the Water Act also provides for the establishment of boards with a view to carrying out the aforesaid purposes for conferring on and assigning to such boards powers and functions relating thereto.

Hazardous and Other Wastes (Management and Transboundary Movement) Rules, 2016 (the “Hazardous Waste Rules”)

The objective of the Hazardous Waste Rules is to control the collection, reception, treatment and storage of hazardous waste. The Hazardous Waste Rules prescribes for every person who is engaged in generation, treatment, processing, packaging, storage, transportation, use, collection, destruction, conversion, recycling, offering for sale, transfer or the like of hazardous and other wastes to obtain an authorisation from the relevant state pollution control board.

The Public Liability Insurance Act, 1991 (the “PLI Act”)

The PLI Act imposes liability on the owner or controller of hazardous substances for any damage arising out of an accident involving such hazardous substances. The government by way of a notification has enumerated a list of hazardous substances. The owner or handler is also required to obtain an insurance policy insuring against liability under the legislation. The rules made under the PLI Act mandate that the owner has to contribute towards the environmental relief fund a sum equal to the premium paid on the insurance policies. The amount is payable to the insurer.

Tax laws

In addition to the aforementioned material legislations which are applicable to our Company, some of the tax legislations that may be applicable to the operations of our Company include:

1. Income Tax Act 1961, the Income Tax Rules, 1962, as amended by the Finance Act in respective years;
2. Central Goods and Service Tax Act, 2017, the Central Goods and Service Tax Rules, 2017 and various state-wise legislations made thereunder;
3. The Integrated Goods and Service Tax Act, 2017 and rules thereof;
4. Professional tax-related state-wise legislations; and
5. Indian Stamp Act, 1899 and various state-wise legislations made thereunder.

Labour Legislations

The Factories Act, 1948 (the “Factories Act”)

The Factories Act defines a “factory” to cover any premises which employs ten or more workers and in which manufacturing process is carried on with the aid of power and, any premises where there are at least twenty workers even though there is no electrically aided manufacturing process being carried on. Each State Government has rules in respect of the prior submission of plans and their approval for the establishment of factories and registration and licensing of factories.

The Factories Act provides that an occupier of a factory i.e. the person who has ultimate control over the affairs of the factory and in the case of a company, any one of the directors must ensure the health, safety and welfare of all workers. There is a prohibition on employing children below the age of fourteen years in a factory. The occupier and the manager of a factory may be punished in accordance with the Factories Act for different offences in case of contravention of any provision thereof and in case of a continuing contravention after conviction, an additional fine for each day of contravention may be levied. Other labour legislations

Other labour laws

Further, in respect of our manufacturing facilities, we use the services of certain licensed contractors who in turn employ contract labour whose number exceeds twenty in respect of certain facilities. Accordingly, we are regulated by the provisions of the Contract Labour (Regulation and Abolition) Act, 1970, as amended (the “CLRA Act”), and the rules framed thereunder which requires us to be registered as a principal employer and prescribes certain obligations with respect to welfare and health of contract labour. The CLRA Act imposes certain obligations on the contractor in relation to establishment of canteens, rest rooms, drinking water, washing facilities, first aid, other facilities, and payment of wages. However, in the event the contractor fails to provide these amenities, the principal employer is under an obligation to provide these facilities within a prescribed time-period. Penalties, including both fines and imprisonment, may be levied for contravention of the provisions of the CLRA Act.

The Industrial Disputes Act, 1947, as amended, provides for statutory mechanism of settlement of all industrial disputes, a term which primarily refers to a dispute or difference between employers and workmen concerning employment or the terms of employment or with the conditions of labour of any person.

The Employee’s Compensation Act, 1923 (the “Employee’s Compensation Act”) aims at providing financial protection to employees and their dependents in case of accidental injury by means of payment of compensation by the employers. The compensation is also payable for some occupational diseases contracted by employees during the course of their employment. The Employee’s Compensation Act prescribes that if personal injury is caused to an employee by accident during employment, his employer would be liable to pay him compensation.

We are subject to other laws concerning condition of working, benefit and welfare of our labourers and employees such as:

- The Industrial Employment (Standing Orders) Act, 1946
- The Employees State Insurance Act, 1948
- The Employees (Provident Fund and Miscellaneous Provisions) Act, 1952
- The Payment of Gratuity Act, 1972
- The Payment of Bonus Act, 1965
- The Minimum Wages Act, 1948
- The Payment of Wages Act, 1936
- The Equal Remuneration Act, 1976
- The Child Labour (Protection Regulation) Act, 1986
- The Maternity Benefit Act, 1961
- The Apprentices Act, 1961
- The Sexual Harassment of Women at Workplace (Prevention, Prohibition and Redressal) Act, 2013
- The Interstate Migrant Workmen Act, 1979
- The Trade Unions Act, 1926

The Occupational Safety, Health and Working Conditions Code, 2020 (enacted by the Parliament of India and assented to by the President of India) will come into force on such date as may be notified in the official gazette by the Central Government and different dates may be appointed for different provisions of the Occupational Safety, Health and Working Conditions Code, 2020. Once effective, it will subsume, *inter alia*, the Factories Act and the CLRA Act.

The Code on Social Security, 2020 (enacted by the Parliament of India and assented to by the President of India) will come into force on such date as may be notified in the official gazette by the Central Government and different date may be appointed for different provisions of the Code on Social Security, 2020. Once effective, it will subsume, *inter alia*, the Employees ‘Compensation Act, 1923, the Employees ‘State Insurance Act, 1948, the Employees Provident Funds and Miscellaneous Provisions Act, 1952, the Maternity Benefit Act, 1961 and the Payment of Gratuity Act, 1972.

The Code on Wages, 2019 (enacted by the Parliament of India and assented to by the President of India) will come into force on such date as may be notified in the official gazette by the Central Government and different date may be appointed for different provisions of the Code on Wages, 2019. Once effective, it will subsume the Equal Remuneration Act, 1976, the Minimum Wages Act, 1948, the Payment of Bonus Act, 1965 and the Payment of Wages Act, 1936.

The Industrial Relations Code, 2020 (enacted by the Parliament of India and assented to by the President of India) will come into force on such date as may be notified in the official gazette by the Central Government and different date may be appointed for different provisions of the Industrial Relations Code, 2020. Once effective, it will subsume the Trade Union Act, 1926, the Industrial Employment (Standing Orders) Act, 1946 and the Industrial Dispute Act, 1947.

Other Applicable Laws

Electricity Act, 2003 (“Electricity Act”)

The Electricity Act is the central legislation which covers, amongst others, generation, transmission, distribution, trading and use of electricity. It governs the establishment, operation and maintenance of any electricity generating company and prescribes technical standards in relation to the connectivity of generating companies with the grid. As per provisions of the Electricity Act, generating companies are required to establish, operate and maintain generating stations, sub-stations and dedicated transmission lines.

Under the Electricity Act, the State Electricity Regulatory Commissions (“**SERCs**”) are required to promote cogeneration and generation of electricity from renewable sources of energy and sale of electricity to any person from sources other than the incumbent distribution licensee under the provisions of open access. The Electricity Act further requires the SERCs to specify, for the purchase of electricity from renewable sources, a percentage of the total consumption of electricity within the area of a distribution licensee, which has been implemented in the form of renewable purchase obligations (“**RPOs**”).

National Electricity Policy, 2005 (“National Electricity Policy”)

The Government of India approved the National Electricity Policy on February 12, 2005, in accordance with the provisions of the Electricity Act. The National Electricity Policy lays down the guidelines for development of the power sector including renewable energy and aims to accelerate the development of power sector by providing supply of electricity to all areas and protecting interests of consumers and other stakeholders. The National Electricity Policy, *inter alia*, provides that the SERCs should specify appropriate tariffs in order to promote renewable energy, until renewable energy power producers relying on non-conventional technologies can compete with conventional sources of energy.

Consumer Protection Act, 2019 (the “Consumer Protection Act”)

The Consumer Protection Act was designed and enacted to provide simpler access to redress consumer grievances. It seeks, *inter alia* to promote and protects the interest of consumers against deficiencies and defects in goods or services and secure the

rights of a consumer against unfair trade practices, which may be practiced by manufacturers or service providers or traders. It establishes consumer disputes redressal forums and commissions for the purposes of redressal of consumer grievances. In addition to awarding compensation and/or corrective orders, the forums and commissions under the Consumer Protection Act are empowered to impose imprisonment of not less than a month, but not exceeding three years, or a fine of not less than ₹25,000, but not more than ₹100,000 or both.

Intellectual Property Laws

Certain laws relating to intellectual property rights such as trademark protection under the Trade Marks Act, 1999 (the “**Trade Marks Act**”) are applicable to us. The Trade Marks Act, which came into force on December 30, 1999, along with the rules and regulations made thereunder govern the law pertaining to trade marks in India. A trade mark is essentially any mark capable of being represented graphically and distinguishing goods or services of one person from those of others and includes a device, brand, heading, label, ticket, name, signature, word, letter, numeral, shape of goods, packaging or combination of colours or any combination thereof. In India, trademarks enjoy protection under both statutory and common law. Registration of a trade mark grants the owner a right to exclusively use the trade mark as a mark of goods and services and prevents the fraudulent use of marks in India.

The Trade Marks Act permits the registration of trade marks for goods and services. Certification trademarks and collective marks can also be registered under the Trade Marks Act. The Registrar of Trade Marks is the authority responsible for, among other things, registration of trade marks, settling opposition proceedings and rectification of the register of trade marks. The Trade Marks (Amendment) Act, 2010 has been enacted to cover Indian nationals as well as foreign nationals to secure simultaneous protection of trade marks in other countries. The Trade Marks (Amendment) Rules, 2013 were enacted to give effect to the Trade Mark (Amendment) Act, 2010.

The Bureau of Indian Standards Act, 2016 (the “BIS Act”)

The BIS Act provides for the establishment of bureau for the standardization, marking and quality certification of goods. Functions of the bureau include, *inter-alia*, (a) recognizing as an Indian standard, any standard established for any article or process by any other institution in India or elsewhere; (b) specifying a standard mark which shall be of such design and contain such particulars as may be prescribed to represent a particular Indian standard; and (c) conducting such inspection and taking such samples of any material or substance as may be necessary to see whether any article or process in relation to which the standard mark has been used conforms to the Indian Standard or whether the standard mark has been improperly used in relation to any article or process with or without a license.

Other Indian laws

In addition to the above, we are also governed by the provisions of the Companies Act and rules framed thereunder, relevant central and state tax laws, foreign exchange and investment laws and foreign trade laws and other applicable laws and regulation imposed by the Central Government and State Governments and other authorities for over day to day business, operations and administration.

HISTORY AND CERTAIN CORPORATE MATTERS

Brief history of our Company

Our Company was incorporated as Sansera Engineering Private Limited on December 15, 1981 at Bengaluru, Karnataka, India as a private limited company under the Companies Act, 1956. Our Company was converted into a public limited company pursuant to a special resolution passed by our Shareholders at the EGM held on June 19, 2018 and the name of our Company was changed to Sansera Engineering Limited. A fresh certificate of incorporation consequent upon conversion to a public limited company was issued by the Registrar of Companies, Karnataka on June 29, 2018.

Changes in Registered Office

Except as disclosed below, there has been no change in registered office of our Company since the date of incorporation.

Date of change of Registered Office	Details of the address of Registered Office	Reasons for change in the Registered Office
June 27, 1997	From 51, Ranga Rao Road, Basavangudi, Bengaluru 560 004, Karnataka, India to 261/C Bommasandra Industrial Area, Hebbagodi Post, Anekal Taluk, Bengaluru 560 099, Karnataka, India	Operational efficiency
July 31, 2018	From 261/C Bommasandra Industrial Area, Hebbagodi Post, Anekal Taluk, Bengaluru 560 099, Karnataka, India to Plant -7 Plot No. 143/A, Jigani Link Road, Bommasandra Industrial Area, Anekal Taluk, Bengaluru 560 105, Karnataka	Operational efficiency

Main Objects of our Company

The main objects contained in the Memorandum of Association of our Company are as follows:

- To carry on the business of manufacture of engineering products such as parts, assemblies and sub-assemblies for automobiles, trucks, Earth moving machinery, locomotives, aircraft, two and three wheelers, industrial machinery, textile machinery, compressors, agricultural pumps and equipment, transmission and transmission bodies, suspension, internal combustion engines and other equipment including machine tools.*

“Engineering products” as used above is meant to include products, parts, fitment assemblies and sub-assemblies in the fields of mechanical, electrical, electronic, hydraulic, pneumatic engineering and other areas in engineering.”
- To carry on the business as agents, distributors, representatives, and dealers in all types of engineering products as detailed above.*
- To offer consultancy services and to act as Consultants in the above fields.*
- To do research and develop tools in the above categories.*
- To undertake, carry out, promote and sponsor rural development, including any programme for promoting the social and economic welfare of, or the uplift of the public in any rural area and to incur any expenditure on any programme of rural development and to assist execution and promotion there of either directly or through an independent agency or in any other manner. And without prejudice to the generality of the foregoing, it is hereby declared that “Programme of rural development” shall also include any programmed for promoting the social and economic welfare of or the uplift of the public in any rural area which the company may consider likely to promote and assist rural development, and that the words “rural area” shall include such areas as may be regarded as rural areas under Section 35CC of the income Tax Act, 1961 or any other modification or re-enactment thereof for the time being in force or any other law relating rural development for the time being in force or any may be regarded by the company as rural areas and the company may, at their discretion, in order to implement any of the above mentioned objects or purposes transfer without consideration or at such fair or concessional value as the company may think fit and divest ownership of any property of the company to or in favour of any Public or Local Body or Authority or Central or State Government, as the Company may deem fit.*
- To undertake, carry out, promote or sponsor or assist any activity for the promotion and growth of national economy and for discharging what the company may consider to be social and moral responsibility to the public or any section of the public as also any activity which the Company considers likely to promoter national welfare or social, economic or moral uplift of the public or any section of the public and in such manner and by such means as the company may think fit and the company may without prejudice to the generality of the foregoing, undertake, carry out, promoter and sponsor any activity for publication of any books, literature, newspapers, etc., or for organizing lectures or seminars likely to advance these objects or for giving merit awards, or for giving scholarships, loans or any other assistance to deserving students or other scholars or person to enable them to pursue their studies or academic pursuits or researches and for establishing, conducting or assisting any body, institution, fund, trust, etc., having any one or more of the aforesaid objects as one or more of its objects by giving donation or otherwise in any other manner and the Company may, in order to implement any of the above mentioned objects or purposes, transfer without consideration*

or at such fair or concessional value as the company may think fit and divest the ownership of any property of the Company to or in favour of any Public or Local Body or Authority or Central or State Government or any Public Institution or Trust as the company deems fit.

7. To carry on the business of manufacturers, fabricators, exporters and importers, dealers in repairs, cleaners, stores and warehouses of automobiles parts and components, sheet metal articles, of any type or for any purpose, gears, engine parts, filters, pumps, boilers, turbines, dynamos, stoves, iron monger, hardware, wireless goods, sewing machines, motor lorries, omnibuses, coaches, ships, marine engines, two and three wheelers, tram cars, locomotives, carriages, trucks, cycles, bicycles, tricycles and other vehicles, plant machinery, machine parts and accessories tools implements and accessories of every kind.
8. To carry on the business of Iron and Steel Founders, Brass Founders, Metal Workers, Metallurgists, Job workers, Mechanical, Civil and Electrical Engineers and Structural Engineers.
9. To manufacture, purchase, sell, use and import and export forgings, heavy castings, medium and light castings and casting in brass, iron, steel, aluminium, copper, gunmetal and plastics, rubber, bakelites, petrochemical products, etc. which are capable of being conveniently made or sold in any of the business aforesaid.
10. To manufacture, import and export Pig Iron, Ferrosilicon, Ferrochrome and other ferrous substances and compounds and also of non-ferrous metals such as aluminium, brass, tin, etc.
11. To carry on the business of founders in all metal, mechanical engineers and generally to deal with the by-products obtained in the process of manufacturing articles for which the Company is established.
12. To transact or carry on all kinds of Agency business including the business of Buying Agents, Selling Agents, Commission Agents, Distributors, etc.”

The main objects as contained in the Memorandum of Association enable our Company to carry on the business presently being carried out.

Amendments to the Memorandum of Association

Set out below are the amendments to our Memorandum of Association in in the last 10 years:

Date of Shareholders' Resolution	Particulars
July 1, 2013	Clause V of the MoA was amended to reflect the increase and reclassification in the authorized share capital of the Company from ₹ 10,000,000 divided into 4,000 cumulative redeemable preference shares of ₹ 100 each and 96,000 Equity Shares of ₹ 100 each to ₹ 220,000,000 divided into 1,150,000 Equity Shares of ₹ 100 each, 300,000 Series A compulsorily convertible preference shares of ₹ 100 each and 750,000 Series B compulsorily convertible preference shares of ₹ 100 each
June 19, 2018	Clause I of the MoA was amended to reflect the change in the name of our Company from Sansera Engineering Private Limited to Sansera Engineering Limited pursuant to the conversion of our Company from a private limited company to a public limited company
July 28, 2018	Clause V of the MoA was amended to reflect the sub-division in the authorized share capital of the Company from ₹220,000,000 divided into 1,150,000* Equity Shares of ₹ 100 each, 300,000 Series A compulsorily convertible preference shares of ₹ 100 each and 750,000 Series B compulsorily convertible preference shares of ₹ 100 each to ₹230,000,000 divided into 62,500,000 Equity Shares of ₹ 2 each, 300,000 Series A compulsorily convertible preference shares of ₹ 100 each and 750,000 Series B compulsorily convertible preference shares of ₹100 each
August 8, 2018	<p>Clause III of the MoA was amended to include the following other objects appearing under Clause III (C) of the MoA in the main objects appearing under Clause III (A) of the MoA:</p> <ol style="list-style-type: none"> 1. “To carry on the business of manufacturers, fabricators, exporters and importers, dealers in repairs, cleaners, stores and warehouses of automobiles parts and components, sheet metal articles, of any type or for any purpose, gears, engine parts, filters, pumps, boilers, turbines, dynamos, stoves, iron monger, hardware, wireless goods, sewing machines, motor lorries, omnibuses, coaches, ships, marine engines, two and three wheelers, tram cars, locomotives, carriages, trucks, cycles, bicycles, tricycles and other vehicles, plant machinery, machine parts and accessories tools implements and accessories of every kind. 2. To carry on the business of Iron and Steel Founders, Brass Founders, Metal Workers, Metallurgists, Job workers, Mechanical, Civil and Electrical Engineers and Structural Engineers. 3. To manufacture, purchase, sell, use and import and export forgings, heavy castings, medium and light castings and casting in brass, iron, steel, aluminium, copper, gunmetal and plastics, rubber, bakelites, petrochemical products, etc. which are capable of being conveniently made or sold in any of the business aforesaid.

Date of Shareholders' Resolution	Particulars
	4. To manufacture, import and export Pig Iron, Ferrosilicon, Ferrochrome and other ferrous substances and compounds and also of non-ferrous metals such as aluminium, brass, tin, etc.
	5. To carry on the business of founders in all metal, mechanical engineers and generally to deal with the by-products obtained in the process of manufacturing articles for which the Company is established.
	6. To transact or carry on all kinds of Agency business including the business of Buying Agents, Selling Agents, Commission Agents, Distributors, etc."

*The authorised equity share capital of our Company was increased from 1,150,000 Equity Shares of ₹ 100 each to 1,250,000 Equity Shares of ₹100 each, effective from April 1, 2017, pursuant to the scheme of amalgamation under Section 233 of the Companies Act, 2013 read with Rule 25 of the Companies (Compromises, Arrangements and Amalgamations) Rules, 2016 for amalgamation of Gearock Forge Private Limited with our Company. For details, see "Details regarding acquisition of business/ undertakings, mergers, amalgamation, revaluation of assets, if any – Scheme of amalgamation of Gearock Forge Private Limited with our Company" on page 192. However, our Company did not reflect an increase in the authorized share capital by way of an amendment to the MoA Further, please refer to "Risk Factors – Our Company was incorporated in 1981 and we are unable to trace some of our historical records. We cannot assure you that no legal proceedings or regulatory actions will be initiated against our Company in the future in relation to the missing filings and corporate records, which may impact our financial condition and reputation." on page 39.

Major events and milestones of our Company

The table below sets forth the key events and milestones of our Company:

Year	Particulars
1986	<ul style="list-style-type: none"> Received first purchase order from Maruti Udyog Limited
1996	<ul style="list-style-type: none"> Commenced operations at Plant 2 situated in Bengaluru which also functions as our Company's headquarters
2000	<ul style="list-style-type: none"> Commenced operations at Gearock Forge, formerly, a 100% subsidiary of our Company
2004	<ul style="list-style-type: none"> Commenced operations at Plant 3 situated in Bengaluru
2005	<ul style="list-style-type: none"> Commenced operations at Plant 4 situated in Manesar, Haryana Commenced operations at Plant 5 situated in Pune
2007	<ul style="list-style-type: none"> Commenced operations at Plant 6 situated in Pantnagar for Bajaj
2008	<ul style="list-style-type: none"> Installed forging and heat treatment facilities in Plant 5 and Plant 6 Commenced operations at Plant 7 situated in Bengaluru
2009	<ul style="list-style-type: none"> Commenced production of connecting rods
2012	<ul style="list-style-type: none"> Commenced operations at Plant 8 situated in Bengaluru
2013	<ul style="list-style-type: none"> Investment by Client Ebene Limited (formerly called CVCIGP II Client Ebene Limited) and CVCIGP II Employee Ebene Limited in our Company
2014	<ul style="list-style-type: none"> Commenced supply of machined connecting rods to TIEI (formerly known as Kirloskar Toyota Textile Machinery Private Limited)
2015	<ul style="list-style-type: none"> Commenced operations at Plant 9 situated in Bengaluru as an aerospace division of our Company
2017	<ul style="list-style-type: none"> Acquired Mape Sweden AB (Trolhattan Sweden), a European manufacturer of machined connecting rods for Heavy commercial vehicles. Mape Sweden AB was subsequently renamed to Sansera Sweden AB Commenced production of brackets for a global aircraft OEM Merged Gearock with Sansera Engineering. Gearock facilities formed Plant 12 of Sansera Expanded forging operations at Plant 14, Bangalore
2018	<ul style="list-style-type: none"> Designated Plant 10 in Bangalore as independent premises for machine building operations Shifted Sansera Sweden to a completely new leased premises, built to our specifications, with scope for further expansion Commenced mass production of Integral Crankshafts
2019	<ul style="list-style-type: none"> Commenced operations at Sansera's largest plant, Plant 11 situated at Bidadi, Bangalore; Commissioned manufacturing line for suspension products - stem comp and started supplies; Commissioned manufacturing line for aluminium forged products and started mass production; Commenced operations at Plant 15 situated at Gujarat
2020	<ul style="list-style-type: none"> Commenced development of multiple drive train components for hybrid vehicles for a global PV OEM Commenced development of suspension and drive train components for a domestic electric 2W OEM; Added TVS as a customer and acquired business across multiple components; Started supplies of braking assembly components and Fitwel started supplies of chassis (cabin tilt system) components for HCVs Fitwel commenced development of steering components for a Tier 1 supplier to PV OEMs
2021	<ul style="list-style-type: none"> Signed a lease for moving current aerospace facility (Plant 9 with built up area of 4,000 sq. m) to a new facility dedicated to aerospace and defence (with a built up area of 13,020 sq. m) Commenced development of braking assembly components for a PV OEM Secured orders and commenced development of machined engine casings in aerospace business Commenced development of BEV drivetrain components for a global electric PV OEM Fitwel Tools and Forgings Private Limited Commenced development of bicycle components for a global manufacturer of power transmission solutions Commenced development of components for the defence segment

Awards, accreditations and recognitions received by our Company

Our Company has received the following awards, accreditations and recognitions:

Year	Awards and Accreditations
2001	<ul style="list-style-type: none"> Awarded the Best Machining award by Yamaha Motors Private Limited
2004	<ul style="list-style-type: none"> Awarded the Supplier award for quality from Honda Motorcycles and Scooters India Private Limited
2005	<ul style="list-style-type: none"> Awarded the Vendor Performance award by Maruti Suzuki India Limited
2007	<ul style="list-style-type: none"> Awarded the Samman Patra Award by the Ministry of Finance, Department of Revenue, Government of India
2008	<ul style="list-style-type: none"> Received ISO 14001:2004 certification for Plant 2 and Plant 3 by TUV NORD CERT GmbH Received BS OHSAS 18001:2007 certification for Plant 2 and Plant 3 by TUV NORD CERT GmbH
2009	<ul style="list-style-type: none"> Awarded the Grand Award for QCDDM by Honda Motorcycles and Scooters India Private Limited
2010	<ul style="list-style-type: none"> Received ISO 14001:2004 certification for Plant 4 and Plant 6 by TUV NORD CERT GmbH Received BS OHSAS 18001:2007 certification for Plant 4 and Plant 6 by TUV NORD CERT GmbH
2011	<ul style="list-style-type: none"> Awarded the Quality and Service Award by Ducati Motor Holding Spa, Italy Received a certificate of recognition as a Star Export House by the Ministry of Commerce and Industry, Government of India Received ISO 14001:2004 certification for Plant 7 by TUV NORD CERT GmbH Received BS OHSAS 18001:2007 certification for Plant 7 by TUV NORD CERT GmbH
2012	<ul style="list-style-type: none"> Received ISO 14001:2004 certification for Plant 5 by TUV NORD CERT GmbH Received BS OHSAS 18001:2007 certification for Plant 5 by TUV NORD CERT GmbH
2013	<ul style="list-style-type: none"> Awarded the Perfect Quality Award by Fiat Received ISO/TS 16949:2009 certification for Plant 5 by TUV NORD CERT GmbH. Awarded the Silver Award for part development by India Yamaha Motors Private Limited Awarded the Quality Excellence Award from General Motors Company Awarded the Prashamsa Suraksha Puraskara by the National Safety Council, Karnataka Chapter Received ISO 14001:2004 certification for Plant 9 by TUV NORD CERT GmbH Received BS OHSAS 18001:2007 certification for Plant 9 by TUV NORD CERT GmbH Rated as "ICRA A1" for short term fund based facilities Rate as "ICRA A" for long term fund based facilities
2014	<ul style="list-style-type: none"> Awarded the Best Collaboration Award by Ducati Motor Holding Spa, Italy Received ISO/TS 16949:2009 certification for Plant 4 by TUV NORD CERT GmbH. Awarded the Quality Excellence Award by General Motors Company Awarded a "3 star rating" by Confederation of Indian Industry – EHS Rated as "ICRA A1" for short term fund based facilities Rated as "ICRA A+" for long term fund based facilities
2015	<ul style="list-style-type: none"> Awarded the Quality Excellence Award by General Motors Company Awarded the Competitiveness Award by General Motors Company Received ISO 9001: 2008 certification for Plant 2, Plant 3 and Plant 7 by TUV India Private Limited Received ISO/TS 16949:2009 certification for Plant 2, Plant 3, Plant 6 and Plant 7 by TUV NORD CERT GmbH Awarded the Express Development Award by GKN Aerospace Rated as "ICRA A-" for long term bank facilities Rated as "ICRA 1+" for short term bank facilities
2016	<ul style="list-style-type: none"> Awarded the Quality Excellence Award by General Motors Company Awarded a "4 star rating" by Confederation of Indian Industry – EHS Received EN ISO 50001:2011 certification for Plant 2 by TUV NORD CERT GmbH Rated as "ICRA AA -" for long term bank facilities Rated as "ICRA A1+" for short term bank facilities
2017	<ul style="list-style-type: none"> Awarded the Quality Performance Award by Volkswagen AG Awarded the Prashamsa Suraksha Puraskara by the National Safety Council, Karnataka Chapter Received ISO/IEC 17025:2005 certification for all facilities situated in Karnataka by National Accreditation Board for Testing and Calibration Laboratories Awarded the Zero Defect Supplies Award by Toyota Kirloskar Motor Awarded the Best Quality Performance Award by Fiat India Automobiles Private Limited Awarded the "2017 Delivery Performance Award" by Polaris Rated as "ICRA AA -" for long term bank facilities Rated as "ICRA A1+" for short term bank facilities
2018	<ul style="list-style-type: none"> Received AS9100D and BS EN ISO 9001:2015 for Plant 9 by UKAS Management System under the Aerospace Sector Certification Scheme Rated as "ICRA AA -" for long term bank facilities Rated as "ICRA A+" for short term bank facilities Awarded the Quality Award Gold from Bajaj Auto Limited for Plant-1, Plant-2 & Plant-7 Awarded the Quality Excellence Award from India Yamaha Motors Awarded Supplier Quality Award from KTM Austria Awarded the Zero PPM & Zero Warranty Award from Fiat India Automobiles Private Limited Awarded the "4 STAR Award from "CII Southern Region Environment, Health & Safety(EHS) Excellence Award

Year	Awards and Accreditations
	<ul style="list-style-type: none"> Awarded the Best Energy Efficient Case Study By Confederation Of Indian Industry (CII)
2019	<ul style="list-style-type: none"> Awarded the FCA EMEA from Fiat- 2019 Awarded the Zero Defect Supply Award from Toyota Kirloskar Motor Awarded the TPM Excellence Award from JIPM – for Plant 6 Awarded the “5 STAR Award” from Confederation of Indian Industry (CII) Health & Safety(EHS) Excellence Award
2020	<ul style="list-style-type: none"> Awarded the Silver Boeing Performance Excellence Award for 2019 from the Boeing Company Awarded the IGBC Green Factory Building Platinum Certification Award to Plant 11 From Confederation Of Indian Industry (CII)
2021	<ul style="list-style-type: none"> Awarded the Supplier Quality Excellence Award from General Motors for Outstanding 2020 performance to General Motors Awarded the Zero Defects Supplies Award from Toyota Industries Engine India Private Limited for 2020 Awarded the Best Quality Supplier Award (Auto) from Toyota Industries Engine India Private Limited for 2020

Time and cost over-runs

There have been no time and cost over-runs in respect of our business operations.

Defaults or re-scheduling, restructuring of borrowings with financial institutions/banks

There have been no defaults that have been called by any financial institution or bank in relation to borrowings availed by our Company from any financial institutions or banks. However, in response to the COVID-19 pandemic, the RBI allowed banks and lending institutions to offer moratoriums to their customers to defer payments under loan agreements until August 31, 2020. Pursuant to such measures, one of our Subsidiaries, Fitwel, applied for availing a moratorium on the term loan/bills discounting amount to ₹16.39 million. For further details, see “*Risk Factors – The COVID-19 pandemic has had, and we expect it to continue to have, a material adverse effect on our business, financial condition, results of operations and cash flows*” on page 22.

Significant financial or strategic partners

As of the date of this Red Herring Prospectus, our Company does not have any significant financial or strategic partners.

Launch of key products or services, entry into new geographies or exit from existing markets, capacity/ facility creation or location of plants

For details of key products or services launched by our Company, entry into new geographies or exit from existing markets, capacity/facility creation and location of our manufacturing facilities, see “*Our Business*” on page 147.

Accumulated Profits or Losses

There are no accumulated profits or losses of any of our Subsidiaries that are not accounted for by our Company in the Restated Consolidated Financial Statements.

Capacity/facility creation and location of plants

For details of our manufacturing capacities and location of plants, see “*Our Business - Manufacturing – Facilities*” on page 173.

Details of guarantees given to third parties by our Promoter Selling Shareholder

As of the date of this Red Herring Prospectus, none of our Promoters have provided guarantees to any third parties.

Details regarding material acquisitions or divestments of business/undertakings, mergers, amalgamation, or any revaluation of assets, in the last 10 years:

Except as disclosed below, our Company has neither acquired any entity, business or undertaking nor undertaken any merger, amalgamation or revaluation of assets, in the last 10 years:

Scheme of amalgamation of Gearock Forge Private Limited (“Gearock Forge”) with our Company as approved by the Ministry of Corporate Affairs, Regional Director, South East Region, Hyderabad (“Scheme of Amalgamation”)

Our Company filed a scheme of amalgamation under Section 233 read with Rule 24 of the Companies (Compromises, Arrangements and Amalgamations) Rules, 2016 before the Regional Director for the transfer and vesting of the entire business and undertaking of Gearock Forge, a wholly owned subsidiary of our Company, with our Company. The rationale for the merger was for securing capital, enabling economic expansion and increasing business operations.

The Scheme of Amalgamation was approved by the Regional Director, South East Region, Ministry of Corporate Affairs through an order dated March 13, 2018 (“**Order**”). Pursuant to the Order, with effect from April 1, 2017, *inter alia*, (i) all the assets and properties (movable, immovable, tangible or intangible, present, future and contingent); (ii) all agreements, rights, contracts (including but not limited to agreements in relation to immovable properties used by Gearock Forge by way of lease, license and business arrangements, licenses, registrations, permits in relation to the business of Gearock Forge); (iii) all intellectual property rights, records, sales materials, computer programmes, manuals, data, brands, including all trademark and patent applications that are pending in the name of Gearock Forge; (iv) all amounts claimed from any governmental authority, refund of taxes, debts (secured and unsecured), liabilities (contingent liabilities) and all other obligations of Gearock Forge; and (v) all employees of Gearock Forge were transferred to our Company. In consideration of the amalgamation, the investment made by our Company in the equity share capital of Gearock Forge were cancelled and no shares were issued by our Company, without there being any further act or deed in furtherance thereof.

The Scheme of Amalgamation came into effect from March 13, 2018 which was the date on which a certified copy of the Order was filed with the RoC, and the amalgamation becoming operative with effect from April 1, 2017.

Share purchase agreement dated August 1, 2014 entered into between our Company, Fitwel, Subramanya Doddaballapur Ramarao, D Narayan, D L Shakunthala, Kavitha Rama Shekar (“Sellers”) and certain key individual shareholders and other shareholders of Fitwel

Our Company entered into a share purchase agreement dated August 1, 2014 with Fitwel, the Sellers, certain key shareholders, other shareholders of Fitwel, in relation to the sale of 67,556 equity shares of Fitwel aggregating to 19.00% of the share capital of Fitwel for a consideration of ₹74,100,150. At the time of execution of the share purchase agreement, our Company was a shareholder of Fitwel, holding 50.99% of the equity shares of the Company. The said 50.99% shareholding comprising of 181,316 equity shares was acquired by our Company on March 20, 2007. Accordingly, the shareholding of our Company in Fitwel increased to 70.00%.

Share purchase agreement dated April 14, 2017 entered into between MAPE Technology S.r.l. and Sansera Mauritius

Sansera Mauritius entered into a share purchase agreement dated April 14, 2017 with MAPE Technology S.r.l. in relation to the purchase of 1,000 shares of MAPE Sweden AB aggregating to 100.00% of the share capital of MAPE Sweden AB for a consideration of EUR 3,500,000 along with expenses incurred for payment of any dividends, fees, asset transfers transaction related expenses.

Our Holding Company

As on the date of this Red Herring Prospectus, and Client Ebene Limited CVCIGP II Employee Ebene Limited are identified as our holding companies in our Restated Financial Statements and the Promoters of our Company are Subramonia Sekhar Vasan, Fatheraj Singhvi, Unni Rajagopal Kothenath and Devappa Devaraj .

Our Subsidiaries

Our Company has three Subsidiaries. Unless stated otherwise, information in relation our Subsidiaries is as on the date of this Red Herring Prospectus.

1. *Fitwel Tools and Forgings Private Limited (“Fitwel”)*

Corporate Information

Fitwel was incorporated on November 19, 1983 under the Companies Act, 1956 as a private limited company. It has its registered office at Unit No. 5, KHT Complex, Antharasanahalli, Tumkur, Karnataka 572 106.

Fitwel is authorized to, *inter-alia*, engage in the business of supplying precision components for automotive as well as non-automotive segments as authorized under the objects clause of its memorandum of association.

Capital Structure

The authorised share capital of Fitwel is ₹15,000,000 divided into 1,500,000 equity shares of face value of ₹10 each and the issued and paid up share capital of Fitwel is ₹3,555,560 divided into 355,556 equity shares of face value of ₹10 each.

Shareholding

Our Company directly holds 248,872 equity shares of face value of ₹10 each aggregating to 70.00 % of the issued and paid up share capital of Fitwel.

2. **Sansera Engineering Pvt. Ltd., Mauritius (“Sansera Mauritius”)**

Corporate Information

Sansera Mauritius was incorporated on November 4, 2016 under the Section 24 of the Mauritius Companies Act, 2001 as a private limited company. It has its registered office at C/o IQ EQ Corporate Services (Mauritius) Ltd, 33, Edith Cavell Street, Port Louis, 11324, Republic of Mauritius. Sansera Mauritius has category 1 global business license issued under the Financial Services Act, 2007.

Sansera Mauritius is authorized to *inter-alia* engage in carrying out global business activities under the Financial Services Act, 2007.

Capital Structure

The stated share capital of Sansera Mauritius is EUR 9,400,000 divided into 10,000 ordinary shares of face value of EUR 10 each, 490,000 optionally redeemable preference shares of face value of EUR 10 each, 30,000 series A optionally redeemable preference shares of face value of EUR 10 each, 30,000 series B optionally redeemable preference shares of face value of EUR 10 each and 380,000 series C optionally redeemable preference shares of face value EUR 10 each.

Shareholding

Our Company directly holds an aggregate of 940,000 shares of Sansera Mauritius comprising of 10,000 ordinary shares of face value of EUR 10 each, 490,000 optionally redeemable preference shares of face value of EUR 10 each, 30,000 series A optionally redeemable preference shares of face value of EUR 10 each, 30,000 series B optionally redeemable preference shares of face value of EUR 10 each and 380,000 series C optionally redeemable preference shares of face value EUR 10 each.

3. **Sansera Sweden AB (“Sansera Sweden”)**

Corporate Information

Sansera Sweden was incorporated on March 24, 2009 with the Swedish Companies Registration Office under the Companies Act 2001 Sweden as a Swedish private limited liability company. It has its registered office at Flygmotorvägen 26, 461 38 Trollhättan, Sweden.

Sansera Sweden is authorized to, *inter-alia*, engage in the business of manufacturing automobile components as authorized under the objects clause of its memorandum of association.

Capital Structure

The authorized share capital of Sansera Sweden is 400,000 SEK divided into 4,000 shares of 100 SEK each and its registered share capital is 100,000 SEK divided into 1,000 shares of 100 SEK each.

Shareholding

Sansera Mauritius directly holds 1,000 shares of face value of SEK 100 each aggregating to 100% of the registered share capital of Sansera Sweden.

Our Associates

Our Company does not have any associate companies.

Our Joint Ventures

As on the date of this Red Herring Prospectus, our Company does not have any joint ventures.

Summary of Key Agreements for our Company

Shareholders’ agreement dated May 29, 2013 entered into amongst our Company, EEL, Client Ebene Limited (formerly called CVCIGP II Client Ebene Limited), Subramonia Sekhar Vasana, Fatheraj Singhvi, Unni Rajagopal Kothenath, Devappa Devaraj, Karthik Das and Anjana Iyer, as amended on March 23, 2016 (collectively, “Shareholders Agreement”)

Our Company, EEL, Client Ebene Limited, Subramonia Sekhar Vasana, Fatheraj Singhvi, Unni Rajagopal Kothenath, Devappa

Devaraj, Karthik Das and Anjana Iyer have entered into a shareholders' agreement *inter-alia* recording their rights and obligations in relation to the operation and management of our Company. Pursuant to the terms of this agreement, Subramonia Sekhar Vasam and Fatheraj Singhvi have agreed, that they shall not directly or indirectly compete with the business of the Company during the subsistence of the agreement. Further, in terms of the agreement, CVCIGP II Employee Ebene Limited and Client Ebene Limited are entitled to appoint four or more directors on the Board of the Company and Subramonia Sekhar Vasam, Fatheraj Singhvi and Unni Rajagopal Kothenath shall be the representatives of the Promoters, on the Board of the Company. The presence of at least two representatives of CVCIGP II Employee Ebene Limited and Client Ebene Limited and one representative of the SHA Promoters are required to constitute valid quorum at Board meetings. Further, CVCIGP II Employee Ebene Limited and Client Ebene Limited are entitled to certain affirmative rights including in respect of issuance of securities, amending the business plan and entering into related party transactions and Promoters are also entitled to certain affirmative rights including in respect of alteration of charter documents, effecting a buy-back and liquidation of our Company. Each Promoter is also entitled to pre-emptive rights in respect of any issuance of securities, periodic information rights in respect of the activities and performance of the Company. Additionally, if the amount realised by CVCIGP II Employee Ebene Limited and Client Ebene Limited is in excess of the investor benchmark rate as specified in the agreement, our Promoters are entitled to 30.00% of the excess amount realized by CVCIGP II Employee Ebene Limited and Client Ebene Limited at the time of their full cash exit, which may be paid in cash or such other method that achieves the same commercial effect.

Amendment agreement dated August 8, 2018 entered into amongst our Company, Singhvi Subramonia Sekhar Vasam, Fatheraj Singhvi, Unni Rajagopal Kothenath and Devappa Devaraj, Client Ebene Limited (“CEL”), CVCIGP II Employee Ebene Limited (“EEL”) and other shareholders, as amended by the first amendment agreement dated March 29, 2019, the second amendment agreement dated November 5, 2019, the third amendment agreement dated January 1, 2020, the fourth amendment agreement dated June 15, 2020, the fifth amendment agreement dated October 21, 2020, the sixth amendment agreement dated January 27, 2021 and the seventh amendment dated April 27, 2021

Pursuant to undertaking the initial public offering of our Company's equity shares, our Company, Singhvi Subramonia Sekhar Vasam, Fatheraj Singhvi, Unni Rajagopal Kothenath and Devappa Devaraj, CEL, EEL and the other shareholders have agreed to waive and amend certain rights as set out in the aforesaid shareholders agreement until the termination of the amendment agreement and terminate the aforesaid shareholders agreement on the date of listing of our Company's Equity Shares on a recognised stock exchange. The parties have agreed to waive the rights of the two investors to adopt Indian GAAP in relation to the financial statements and have agreed to terminate their information rights under the shareholders agreement. Further, the board composition has been amended to reflect that the CEL may nominate one director to the board of our Company, provided that it holds at least 5% of the issued and paid-up capital of our Company on a fully diluted basis and that EEL would not have the right to appoint nominee directors on the board of our Company. Further, the Promoters of our Company are permitted to nominate two directors subject to the Promoters cumulatively holding at least 5% of the issued and paid-up capital on a fully diluted basis. In addition, in the event of a full cash exit by CEL and EEL and the amount realised by CEL and EEL being in excess of the investor benchmark rate, as specified in the agreement, our Promoters are entitled to 30.00% of such excess amount realized by CEL and EEL at the time of their full cash exit, which may be paid in cash or such other method that achieves the same commercial effect (“**Promoter Upside**”). The right of CEL, EEL and the Promoters to appoint nominee directors, and the right of our Promoters to receive the Promoter Upside shall survive the termination of the aforesaid shareholders agreement, subject to receipt of shareholders approval by way of a special resolution, post listing of the Equity Shares pursuant to the Offer. CEL and EEL have waived their right to effect a sale event as prescribed under the shareholders agreement from the date of filing the red herring prospectus until the date of listing of Equity Shares. This amendment agreement will terminate automatically in the event that either of CEL or EEL withdraw their participation in the Offer

Share subscription agreement dated May 29, 2013 entered into amongst our Company, CVCIGP II Employee Ebene Limited, Client Ebene Limited (formerly called CVCIGP II Client Ebene Limited), Subramonia Sekhar Vasam, Fatheraj Singhvi, Unni Rajagopal Kothenath, Devappa Devaraj, Karthik Das and Anjana Iyer, as amended on March 23, 2016

Pursuant to the share subscription agreement, as amended (i) CVCIGP II Employee Ebene Limited subscribed to 107,700 Series A CCPS and 269,250 Series B CCPS of the Company and (ii) Client Ebene Limited subscribed to 192,300 Series A CCPS and 480,750 Series B CCPS of the Company. For further details, see “*Capital Structure – Share capital history of our Company*” on page 68.

Share purchase agreement dated May 29, 2013 entered into amongst our Company, Subramonia Sekhar Vasam, Fatheraj Singhvi, Unni Rajagopal Kothenath, Devappa Devaraj, certain members of the promoter group (as defined in the agreement), CVCIGP II Employee Ebene Limited and Client Ebene Limited (formerly called CVCIGP II Client Ebene Limited)

Pursuant to the share purchase agreement, Subramonia Sekhar Vasam, Fatheraj Singhvi, Unni Rajagopal Kothenath, Devappa Devaraj and certain members of the promoter group (as defined in the agreement) transferred 30,349 Equity Shares of the Company for a consideration of ₹2,283,458,760 to CVCIGP II Employee Ebene Limited and Client Ebene Limited aggregating to 51.00% of the share capital of our Company.

Share Purchase Agreement dated May 29, 2013 entered into amongst our Company, CVCIGP II Employee Ebene Limited and Client Ebene Limited (formerly called CVCIGP II Client Ebene Limited), Monsoon India Select Equity Fund Limited and Monsoon India Select Equity Fund 2 Limited

Pursuant to the share purchase agreement, Monsoon India Select Equity Fund and Monsoon India Select Equity Fund 2 Limited transferred 517 and 913 Equity Shares of the Company aggregating to 2.21% of the equity share capital of our Company to CVCIGP II Employee Ebene Limited and Client Ebene Limited for a consideration of ₹44,408,749 and ₹78,423,961, respectively.

Agreements with Key Managerial Personnel, Director, Promoter or any other employee

Our Promoters are entitled to 30.00% of the excess amount realized by CVCIGP II Employee Ebene Limited and Client Ebene Limited at the time of their full cash exit, which may be paid in cash or such other method that achieves the same commercial effect (“**Promoter Upside**”), and such right to Promoter Upside shall survive the termination of the aforesaid shareholders agreement, subject to receipt of shareholders’ approval by way of a special resolution, post listing of the Equity Shares pursuant to the Offer. As on the date of this Red Herring Prospectus, there are no agreements entered into by a Key Managerial Personnel or Director or any other employee of our Company, either by themselves or on behalf of any other person, with any shareholder or any other third party with regard to compensation or profit sharing in connection with dealings in the securities of our Company.

Common Pursuits between our Company and Subsidiaries

Our Subsidiaries are engaged in lines of business that are similar to our Company. For details, see “*Our Business – Corporate Structure – Our Subsidiaries*” and “*History and Certain Corporate Matters – Our Subsidiaries*” on pages 159 and 193. We shall adopt necessary procedures and practices as permitted by law to address any conflict situations, as and when they may arise. Further, in the event that our Company undertakes a divestment of its shareholding in any of the Subsidiaries, a conflict in operations of our Subsidiaries and our Company may arise to the extent of the common activities. For further details of related business transactions and their significance on the financial performance of our Company, see “*Financial Statements – Note 41 – Related party disclosures*” on page 261.

Business interest of our Subsidiaries in our Company

Except as disclosed in the section “*Other Financial Information – Related Party Transactions*” on page 280, our Subsidiaries do not have or propose to have any business interest in our Company.

OUR MANAGEMENT

Board of Directors

In terms of our Articles of Association, our Company is required to have not less than three Directors and not more than 12 Directors. As on the date of this Red Herring Prospectus, our Board comprises of six Directors, including, two Executive Directors, one Non-Executive Nominee Director and three Non-Executive Independent Directors. Our Board comprises of one woman, independent Director.

The following table sets forth details regarding our Board of Directors:

Sl. No.	Name, designation, address, occupation, nationality, period and term and DIN	Age (years)	Other directorships
1.	<p>Subramonia Sekhar Vasan <i>Designation:</i> Chairman and Managing Director</p> <p><i>Address:</i> #51, Oriental Home, Ranga Rao Road, Basavangudi, Bangalore South, Bengaluru 560 004, Karnataka, India</p> <p><i>Occupation:</i> Business</p> <p><i>Date of birth:</i> March 2, 1953</p> <p><i>Period:</i> Appointed since December 15, 1981</p> <p><i>Term:</i> Appointed for a period of five years i.e. from July 8, 2020 to July 7, 2025. Not liable to retire by rotation.</p> <p><i>DIN:</i> 00361245</p>	68	Nil
2.	<p>Fatheraj Singhvi <i>Designation:</i> Joint Managing Director</p> <p><i>Address:</i> #416 & 232, Shanthi, 8 Vishranthi Enclave, Kankpura Road, Doddakallasandra, Bengaluru 560 062, Karnataka, India</p> <p><i>Occupation:</i> Business</p> <p><i>Date of birth:</i> March 15, 1955</p> <p><i>Period:</i> First appointed on March 3, 1991. Vacated office on June 11, 2018.</p> <p><i>Term:</i> Appointed for a period of five years i.e. from August 6, 2019 to August 5, 2024. Liable to retire by rotation.</p> <p><i>DIN:</i> 00233146</p>	66	<ul style="list-style-type: none"> • Exdion Solutions Private Limited
3.	<p>Raunak Gupta <i>Designation:</i> Non-Executive, Nominee Director*</p> <p><i>Address:</i> B-1608, Oberoi Splendor, JVLR, Andheri (East), Mumbai 400 060, Maharashtra, India</p> <p><i>Occupation:</i> Service</p> <p><i>Date of birth:</i> December 28, 1978</p> <p><i>Period:</i> Appointed since July 8, 2013</p> <p><i>Term:</i> Appointed with effect from July 27, 2018. Liable to retire by rotation.</p> <p><i>DIN:</i> 06624489</p>	42	<ul style="list-style-type: none"> • Leap Green Energy Private Limited
4.	<p>Muthuswami Lakshminarayan <i>Designation:</i> Non-Executive, Independent Director</p>	74	<ul style="list-style-type: none"> • ASM Technologies Limited; • Brose India Automotive Systems Private Limited;

Sl. No.	Name, designation, address, occupation, nationality, period and term and DIN	Age (years)	Other directorships
	<p>Address: #18 Arbors by the Lake, Kyalasanhalli, Off Jigani Link Road, Anekal Taluk, Bengaluru 560 105, Karnataka, India</p> <p>Occupation: Professional</p> <p>Date of birth: September 7, 1946</p> <p>Period: Appointed since July 28, 2018.</p> <p>Term: Appointed with effect from July 28, 2018 for a period of three years. Re-appointed for a period of five years i.e. from July 28, 2021 to July 27, 2026. Not liable to retire by rotation.</p> <p>DIN: 00064750</p>		<ul style="list-style-type: none"> • Dickinson Fowler Private Limited; • Janaadhar (India) Private Limited; • Kirloskar Oil Engines Limited; • Kostal India Private Limited; • Suprajit Engineering Limited; • TVS Automobile Solutions Private Limited; • TVS Electronics Limited; • Wabco India Limited; and • Wendt India Limited
5.	<p>Revathy Ashok</p> <p>Designation: Non-Executive, Independent Director</p> <p>Address: 139/6-2, Domlur Layout, Sharadamma Layout, Bengaluru 560 071, Karnataka, India</p> <p>Occupation: Professional</p> <p>Date of birth: January 16, 1959</p> <p>Period: Appointed since July 28, 2018.</p> <p>Term: Appointed with effect from July 28, 2018 for a period of three years. Re-appointed for a period of five years i.e. from July 28, 2021 to July 27, 2026. Not liable to retire by rotation.</p> <p>DIN: 00057539</p>	62	<ul style="list-style-type: none"> • ADC India Communications Limited; • Astrazeneca Pharma India Limited; • Athena Infonomics India Private Limited; • Khemeia Technologies Private Limited; • Manipal Cigna Health Insurance Company Limited; • Microland Limited; • Qess Corp Limited; • Shell MRPL Aviation Fuels and Services Limited; • Welspun Corp Limited; and • Welspun Tradings Limited.
6.	<p>Sylvain Bilaine</p> <p>Designation: Non-Executive, Independent Director</p> <p>Address: 18-A, Rue Jean Marx Mamer, Luxembourg 8250</p> <p>Occupation: Professional</p> <p>Date of birth: April 13, 1954</p> <p>Period: Appointed since July 28, 2018.</p> <p>Term: Appointed with effect from July 28, 2018 for a period of three years. Re-appointed for a period of one year i.e. from July 28, 2021 to July 27, 2022. Not liable to retire by rotation.</p> <p>DIN: 00128817</p>	67	Nil

*Raunak Gupta is a Nominee Director of Client Ebene Limited.

Relationship between our Directors or to the Key Managerial Personnel

None of our Directors are related to each other or to any of the Key Managerial Personnel.

Brief Biographies of Directors

Subramonia Sekhar Vasan is the Chairman and Managing Director of our Company. He has been a Director of our Company since incorporation. He holds a bachelor's degree in technology from Indian Institute of Technology, Madras and a post graduate diploma in management from Indian Institute of Management, Bangalore. He has over 39 years of professional experience.

Fatheraj Singhvi is the Joint Managing Director of our Company. He is currently the chairman of Pillar 3 of ACMA overseeing the activities of ACT, ASDC, HR, YBLF. He has over 39 years of professional experience. He is a chartered accountant and is a member of the Institute of Chartered Accountants of India. He was a partner at of M/s. Singhvi, Dev & Unni from 1981 to 2006. He manages the Artificial Limb's Centre and Dialysis Centre for Karnataka Marwari Youth Federation since 1982.

Raunak Gupta is a Non-Executive, Nominee Director of our Company. He holds a bachelor's of technology (textile) degree from the Indian Institute of Technology, Delhi and a post graduate diploma in computer aided management from the Indian Institute of Management, Calcutta. He is currently employed with TRG Advisors India Private Limited as a director. He was previously employed with Citi Venture Capital International, Motilal Oswal Investment Advisors Private Limited, Rabo India Securities Private Limited and Infosys Technologies Limited.

Muthuswami Lakshminarayan is a Non-Executive, Independent Director of our Company. He holds a master's degree in technology from Indian Institute of Technology, Bombay. He spent over 21 years at Bosch Limited and over seven years at Harman International (India) Private Limited in the capacities of Managing Director, Country Manager, India and Advisory Chairman.

Revathy Ashok is a Non-Executive, Independent Director of our Company. She holds a post graduate diploma in management with specialisation in habitat and environmental studies from the Indian Institute of Management, Bangalore. She has also been awarded the faculty medal for best performance in Habitat & Environmental Studies from the Indian Institute of Management, Bangalore. She has previously worked at Tishman Speyer India Private Limited and was the chief financial officer of Syntel Inc.

Sylvain Bilaine is a Non-Executive Director, Independent Director of our Company. He holds an engineering degree in electrochemistry and electro metallurgy from the National Higher College, Polytechnic National Institute of Grenoble. He has also successfully completed the program for executive development from the International Institute for Management Development in Lausanne, Switzerland. He has previously worked at Renault for 26 years. Later, he founded and managed SY. B Consulting, a limited liability company involved in the business of management consulting and international business development.

Confirmations

None of our Directors is or was a director of any listed company during the last five years preceding the date of this Red Herring Prospectus, whose shares have been or were suspended from being traded on any of the stock exchanges during the term of their directorship in such company.

None of our Directors is or was a director of any listed company which has been or was delisted from any stock exchange.

No consideration in cash or shares or otherwise has been paid or agreed to be paid to any of our Directors or to the firms or companies in which they are interested by any person either to induce them to become or to help them qualify as a Director, or otherwise for services rendered by them or by the firm or company in which they are interested, in connection with the promotion or formation of our Company.

Terms of appointment of Executive Directors

1. Remuneration to Executive Directors:

- (i) Subramonia Sekhar Vasam is the Chairman and Managing Director of our Company. Our Board and its Shareholders in their meeting held on September 8, 2020 and December 24, 2020 respectively, approved the appointment of Subramonia Sekhar Vasam as the Managing Director for another term for a period of five years with effect from July 8, 2020 to July 7, 2025. The details of remuneration governing his appointment as approved by the Shareholders in their meeting held on December 24, 2020 are as stated below:

Particulars	Remuneration
Basic Salary	₹0.86 million as the basic salary per month
Benefits, Perquisites and allowances	He is entitled to receive benefits, perquisites and allowances including <i>inter alia</i> (i) allowances, contribution towards provident fund, superannuation fund or annuity fund and gratuity fund, as per the rules of our Company; (ii) mediclaim insurance premium per month; (iii) leave in accordance with the rules of our Company. Privilege leave earned but not availed is encashable, in accordance with the rules of our Company; and (iv) carpool, travel expenditure, excluding personal travel, facilities of any one club for business purposes and personal security.

During Fiscal 2021, Subramonia Sekhar Vasam was a paid remuneration of ₹7.45 million by the Company. Further, he has not been paid any remuneration in Fiscal 2021 by our Subsidiaries, including contingent or deferred compensation.

- (ii) Fatheraj Singhvi is the Joint Managing Director of our Company. Our Board in their meeting dated August 6, 2019 and the Shareholders in their meeting dated September 27, 2019 approved the appointment of Fatheraj Singhvi as the Joint Managing Director for a period of five years with effect from August 6, 2019 to August 5, 2024. Further, pursuant

to the Board meeting dated March 18, 2021 and the shareholders meeting dated June 2, 2021, Fatheraj Singhvi's term was amended to be liable to retire by rotation, with effect from March 18, 2021 for a period of five years. The details of remuneration governing his appointment as approved by the shareholders in their meeting held on September 27, 2019 are as stated below:

Particulars	Remuneration
Salary	₹1.25 million per month comprising of ₹0.86million as the basic salary and a special allowance of ₹0.38 million (excluding employer's contribution to provident fund and medical insurance with annual increments)
Benefits, Perquisites, allowances	He is entitled to receive benefits, perquisites and allowances including <i>inter alia</i> (i) contribution towards provident fund, superannuation fund or annuity fund and gratuity fund, as per the rules of our Company; (ii) mediclaim insurance premium per month; (iii) leave in accordance with the rules of our Company. Privilege leave earned but not availed is encashable, in accordance with the rules of our Company; and (iv) carpool, travel expenditure, excluding personal travel, facilities of any one club for business purposes and personal security.

During Fiscal 2021, Fatheraj Singhvi was a paid remuneration of ₹7.45 million by the Company. Further, he has not been paid any remuneration in Fiscal 2021 by our Subsidiaries, including contingent or deferred compensation.

2. Remuneration to Non-Executive Directors:

Independent Directors

Pursuant to the Board resolution dated July 27, 2018 each Non-Executive, Independent Director was entitled to receive sitting fees of ₹25,000 and ₹12,500 per meeting for attending meetings of the Board and Committees of the Board, along with fixed commission of ₹1.20 million per annum respectively, within the limits prescribed under the Companies Act, and the rules made thereunder. Furthermore, in the Board meeting dated September 8, 2020 the Non-Executive, Independent Directors had voluntarily reduced their fixed commission by 50% for the Fiscal 2021. The details of remuneration paid to our independent Directors during Fiscal 2021 are as follows:

S. No.	Name of Director	Sitting fees paid (in ₹ million)	Commission (in ₹ million)
1.	Sylvain Bilaine	0.15	0.53
2.	Muthuswami Lakshminarayan	0.11	0.60
3.	Revathy Ashok	0.16	0.60

No sitting fee was paid to our Non-Executive Nominee Director in the Fiscal 2021.

Arrangement or understanding with major Shareholders, customers, suppliers or others

Pursuant to the Shareholders' Agreement, Raunak Gupta has been appointed as the nominee Director of Client Ebene Limited on our Board. Except as stated above, there is no arrangement or understanding with the major Shareholders, customers, suppliers or others, pursuant to which any of our Directors was appointed on the Board.

Shareholding of Directors in our Company

Our Directors are not required to hold any qualification shares.

The shareholding of our Directors in our Company as of the date of filing this Red Herring Prospectus is set forth below:

Name of Director	Number of Equity Shares	Pre-Offer Percentage Shareholding (%)
Subramonia Sekhar Vasan	12,307,600	23.96
F.R. Singhvi*	3,366,925	6.55

* Pursuant to the provisions of a memorandum of understanding executed between Fatheraj Singhvi and the Singhvi Family Shareholders, dated May 15, 2013, Fatheraj Singhvi is acting in trust in relation to 2,030,000 Equity Shares held by the Singhvi Family Shareholders.

Shareholding of Directors in our Subsidiaries

None of our Directors hold any equity shares in our Subsidiaries.

Appointment of relatives of our Directors to any office or place of profit

None of the relatives of our Directors currently holds any office or place of profit in our Company.

Interest of Directors

All Directors may be deemed to be interested to the extent of fees payable to them for attending meetings of our Board or a Committee thereof as well as to the extent of other remuneration and reimbursement of expenses payable to them under our Articles of Association, and to the extent of remuneration paid to them for services rendered as an officer or employee of our Company and to the extent of benefits arising out of such shareholding and to the extent of the transactions entered into in the

ordinary course of business with the companies in which our Directors hold directorship. The nominee Director of Client Ebene Limited may be interested to the extent of any equity shares held by Client Ebene Limited and to the extent of any benefits arising out of such shareholding.

Except as stated in “*Financial Statements*” on page 219, and to the extent of shareholding in our Company, if any, our Directors do not have any other interest in our business.

None of our Directors have any interest in any property acquired or proposed to be acquired by the Company.

Our Directors have no interest in any transaction by our Company for acquisition of land, construction of building or supply of machinery.

Other than Subramonia Sekhar Vasana and Fatheraj Singhvi who are interested in the promotion of our Company as disclosed in “*Our Promoters and Promoter Group*” on page 211, none of our Directors have any interest in the promotion of our Company other than in the ordinary course of business.

No amount or benefit has been paid or given within the two preceding years or is intended to be paid or given to any of our Directors except the normal remuneration for services rendered as Directors.

No loans have been availed by our Directors from our Company.

None of the beneficiaries of loans, advances and sundry debtors are related to the Directors of our Company.

None of the Directors is party to any bonus or profit sharing plan of our Company other than the performance linked incentives given to each of the Directors.

Changes in the Board in the last three years

Name	Date of Appointment/Change/ Cessation	Reason
Sylvain Bilaine	July 28, 2021	Re-appointed of directorship
Revathy Ashok	July 28, 2021	Re-appointed of directorship
Muthuswami Lakshminarayan	July 28, 2021	Re-appointed of directorship
Sylvain Bilaine	July 28, 2021	Cessation of directorship
Revathy Ashok	July 28, 2021	Cessation of directorship
Muthuswami Lakshminarayan	July 28, 2021	Cessation of directorship
Subramonia Sekhar Vasana	July 8, 2020	Appointed as the Chairman and Managing Director
Fatheraj Singhvi	August 6, 2019	Appointed as the Joint Managing Director
Fatheraj Singhvi	August 6, 2019	Appointed as an Additional Director
Unni Rajagopal Kothenath	August 6, 2019	Resigned as a Non-executive Director

Borrowing Powers of Board

Pursuant to our Articles of Association, and in accordance with the provisions of the Companies Act and the rules made thereunder, our Board is authorised to borrow such monies together with the money already borrowed does not exceed ₹10,000 million

Corporate Governance

The corporate governance provisions of the SEBI Listing Regulations will be applicable to us immediately upon the listing of the Equity Shares with the Stock Exchanges. The corporate governance framework is based on an effective independent Board, separation of the Board’s supervisory role from the executive management team, constitution of the Board committees and formulation of policies, each as required under law, including the SEBI Listing Regulations. We are in compliance with the requirements of the applicable regulations, including the SEBI Listing Regulations, the Companies Act and the SEBI ICDR Regulations, in respect of corporate governance particularly in relation to constitution of the Board and committees thereof and formulation of policies.

Our Board has been constituted in compliance with the Companies Act, 2013 and the SEBI Listing Regulations.

The Board of Directors functions either as a full board or through various committees constituted to oversee specific operational areas. The executive management provides the Board of Directors detailed reports on its performance periodically.

Committees of the Board

In addition to the committees of our Board detailed below, our Board may from time to time, constitute committees for various functions.

Audit Committee

The members of the Audit Committee are:

1. Revathy Ashok, *Chairperson*;
2. Muthuswami Lakshminarayan; and
3. Fatheraj Singhvi

The Audit Committee was constituted by a meeting of the Board of Directors held on July 31, 2018 and was last reconstituted by the Board at their meeting held on August 6, 2019. The scope and functions of the Audit Committee is in accordance with Section 177 of the Companies Act, 2013, Regulation 18 of the SEBI Listing Regulations and its terms of reference include the following:

- a. Overseeing our Company's financial reporting process and disclosure of its financial information to ensure that the financial statement is correct, sufficient and credible;
- b. Recommending to the Board, the appointment, re-appointment, and replacement, remuneration and terms of appointment of the internal auditor, cost auditor and statutory auditor and the fixation of audit fee;
- c. Reviewing and monitoring the auditor's independence and performance and the effectiveness of audit process;
- d. Approving payments to the statutory auditors, internal and cost auditors for any other services rendered by statutory auditors, internal and cost auditors;
- e. Reviewing with the management, the annual financial statements and auditor's report thereon before submission to the Board for approval, with particular reference to:
 - i) Matters required to be stated in the Director's responsibility statement to be included in the Board's report in terms of Section 134(3)(c) of the Companies Act, 2013;
 - ii) Changes, if any, in accounting policies and practices and reasons for the same;
 - iii) Major accounting entries involving estimates based on the exercise of judgment by management;
 - iv) Significant adjustments made in the financial statements arising out of audit findings;
 - v) Compliance with listing and other legal requirements relating to financial statements;
 - vi) Disclosure of any related party transactions; and
 - vii) Qualifications and modified opinions in the draft audit report.
- f. Reviewing with the management, the quarterly, half-yearly and annual financial statements before submission to the Board for approval;
- g. Scrutiny of inter-corporate loans and investments;
- h. Valuation of undertakings or assets of our Company, wherever necessary;
- i. Evaluating internal financial controls and risk management systems;
- j. Approving or subsequently modifying transactions of our Company with related parties, provided that the audit committee may make omnibus approval for related party transactions proposed to be entered into by our Company subject to such conditions as may be prescribed;
Explanation: The term "related party transactions" shall have the same meaning as provided in Regulation 2(1)(zc) of the SEBI Listing Regulations and/or the applicable Accounting Standards and/or Companies Act, 2013.
- k. Reviewing with the management, the statement of uses/application of funds raised through an issue (public issue, rights issue, preferential issue, etc.), the statement of funds utilized for purposes other than those stated in the offer document/prospectus/notice and the report submitted by the monitoring agency monitoring the utilisation of proceeds of a public or rights issue, and making appropriate recommendations to the Board to take up steps in this matter;
- l. Evaluating undertakings or assets of our Company, wherever necessary;
- m. Establishing a vigil mechanism for directors and employees to report their genuine concerns or grievances;
- n. Reviewing, with the management, the performance of statutory and internal auditors and adequacy of the internal control systems;

- o. Reviewing the adequacy of internal audit function, if any, including the structure of the internal audit department, staffing and seniority of the official heading the department, reporting structure coverage and frequency of internal audit;
- p. Discussing with internal auditors on any significant findings and follow up thereon;
- q. Reviewing the findings of any internal investigations by the internal auditors into matters where there is suspected fraud or irregularity or a failure of internal control systems of a material nature and reporting the matter to the Board;
- r. Discussing with statutory auditors, internal auditors, secretarial auditors and cost auditors before the audit commences, about the nature and scope of audit as well as post-audit discussion to ascertain any area of concern;
- s. Looking into the reasons for substantial defaults in the payment to the depositors, debenture holders, shareholders (in case of non-payment of declared dividends) and creditors;
- t. Approving appointment of the chief financial officer (i.e., the whole-time Finance Director or any other person heading the finance function or discharging that function) after assessing the qualifications, experience and background, etc. of the candidate;
- u. Reviewing the functioning of the whistle blower mechanism, in case the same is existing;
- v. Carrying out any other functions as provided under the Companies Act, the SEBI Listing Regulations and other applicable laws;
- w. Formulating, reviewing and making recommendations to the Board to amend the Audit Committee charter from time to time;
- x. Reviewing the utilisation of loan and/or advances from investment by the holding company in the subsidiary exceeding ₹100 crore or 10% of the asset size of the subsidiary, whichever is lower including existing loans / advances / investments; and
- y. Consider and comment on rationale, cost-benefits and impact of schemes involving merger, demerger, amalgamation etc., on the listed entity and its shareholders.

The powers of the Audit Committee include the following:

- a) To investigate activity within its terms of reference;
- b) To seek information from any employees;
- c) To obtain outside legal or other professional advice;
- d) To secure attendance of outsiders with relevant expertise, if it considers necessary; and
- e) To have full access to the information contained in the records of the Company.

The Audit Committee shall mandatorily review the following information:

- a) Management discussion and analysis of financial condition and result of operations;
- b) Statement of significant related party transactions (as defined by the Audit Committee), submitted by management;
- c) Management letters/letters of internal control weaknesses issued by the statutory auditors;
- d) Internal audit reports relating to internal control weaknesses;
- e) The appointment, removal and terms of remuneration of the chief internal auditor; and
- f) Statement of deviations:
 - (i) quarterly statement of deviation(s) including report of monitoring agency, if applicable, submitted to stock exchange(s) in terms of Regulation 32(1) of the SEBI Listing Regulations; and
 - (ii) annual statement of funds utilized for purposes other than those stated in the offer document/prospectus/notice in terms of Regulation 32(7) of the SEBI Listing Regulations.

The Audit Committee is required to meet at least four times in a year under the SEBI Listing Regulations.

Nomination and Remuneration Committee

The members of the Nomination and Remuneration Committee are:

1. Revathy Ashok, *Chairperson*;
2. Raunak Gupta; and
3. Sylvain Bilaine.

The Nomination and Remuneration Committee was constituted as the Compensation Committee by a meeting of the Board of Directors held on July 31, 2018. The scope and functions of the Nomination and Remuneration Committee is in accordance with Section 178 of the Companies Act, 2013 and regulation 19 of the SEBI Listing Regulations. The terms of reference of the Nomination and Remuneration Committee include the following:

- a. Formulating the criteria for determining qualifications, positive attributes and independence of a director and recommend to the Board a policy, relating to the remuneration of the directors, key managerial personnel and other employees;
- b. Formulation of criteria for evaluation of performance of the independent directors and the Board;
- c. Devising a policy on Board diversity;
- d. Identifying persons who are qualified to become directors or who may be appointed in senior management in accordance with the criteria laid down, recommending to the Board their appointment and removal and carrying out evaluation of every director's performance. Our Company shall disclose the remuneration policy and the evaluation criteria in its annual report;
- e. Analysing, monitoring and reviewing various human resource and compensation matters;
- f. Determining our Company's policy on specific remuneration packages for executive directors including pension rights and any compensation payment, and determining remuneration packages of such directors;
- g. Recommending to the board, all remuneration, in whatever form, payable to senior management;
- h. Determining compensation levels payable to the senior management personnel and other staff (as deemed necessary), which shall be market-related, usually consisting of a fixed and variable component;
- i. Reviewing and approving compensation strategy from time to time in the context of the then current Indian market in accordance with applicable laws;
- j. Performing such functions as are required to be performed by the compensation committee under the Securities and Exchange Board of India (Share Based Employee Benefits) Regulations, 2014 including the following:
 - (i) administering the employees' stock option plan (the "**Plan**");
 - (ii) determining the eligibility of employees to participate under the Plan;
 - (iii) granting options to eligible employees and determining the date of grant;
 - (iv) determining the number of options to be granted to an employee;
 - (v) determining the exercise price under the Plan;
 - (vi) deciding on matters such as quantum of and milestones for grant, eligibility of employees who shall be entitled to grant of options, vesting period and conditions thereof, termination policies, etc.; and
 - (vii) construing and interpreting the Plan and any agreements defining the rights and obligations of our Company and eligible employees under the Plan, and prescribing, amending and/or rescinding rules and regulations relating to the administration of the Plan.
- k. Framing suitable policies and systems to ensure that there is no violation, as amended from time to time, of any securities laws or any other applicable laws in India or overseas, including:
 - (i) The Securities and Exchange Board of India (Prohibition of Insider Trading) Regulations, 2015; or

(ii) The Securities and Exchange Board of India (Prohibition of Fraudulent and Unfair Trade Practices relating to the Securities Market) Regulations, 2003;

- l. Determining whether to extend or continue the term of appointment of the independent director, on the basis of the report of performance evaluation of independent directors; and
- m. Performing such other activities as may be delegated by the Board of Directors and/or are statutorily prescribed under any law to be attended to by such committee.

Stakeholders' Relationship Committee

The members of the Stakeholders' Relationship Committee are:

1. Muthuswami Lakshminarayan, *Chairperson*;
2. Fatheraj Singhvi; and
3. Subramonia Sekhar Vasam.

The Stakeholders' Relationship Committee was constituted by our Board of Directors at their meeting held on March 18, 2021. The scope and functions of the Stakeholders' Relationship Committee is in accordance with Section 178 of the Companies Act, 2013 and Regulation 20 of the SEBI Listing Regulations. The terms of reference of the Stakeholders' Relationship Committee include the following:

- a. Redressal of grievances of security holders, including complaints related to the transfer/transmission of shares, non receipt of new/duplicate share certificates and review of cases for refusal of transfer/ transmission of shares and debentures, non-receipt of balance sheet, non-receipt of declared dividends, non-receipt of annual reports, general meetings, etc. and assisting with quarterly reporting of such complaints;
- b. Review of measures taken for effective exercise of voting rights by shareholders;
- c. Review of the various measures and initiatives taken by our Company for reducing the quantum of unclaimed dividends and ensuring timely receipt of dividend warrants/ annual reports/ statutory notices by the shareholders of our Company;
- d. Giving effect to allotment of shares, approval of transfer or transmission of shares, debentures or any other securities;
- e. Dematerialisation of shares and re-materialisation of shares, issue of duplicate certificates and new certificates on split/ consolidation/ renewal;
- f. Review of adherence to the service standards adopted by our Company in respect of various services being rendered by the registrar and share transfer agents;
- g. Oversee the performance of the registrars and transfer agents of our Company and to recommend measures for overall improvement in the quality of investor services; and
- h. Carrying out any other function as prescribed under the SEBI Listing Regulations, Companies Act, 2013 and the rules and regulations made thereunder, each as amended or other applicable law.

Corporate Social Responsibility Committee

The members of the Corporate Social Responsibility Committee are:

1. Subramonia Sekhar Vasam, *Chairperson*;
2. Sylvain Bilaine; and
3. Fatheraj Singhvi.

The Corporate Social Responsibility Committee was constituted by our Board of Directors at their meeting held on March 7, 2014 and was last reconstituted by the Board at their meeting held on August 6, 2019. The terms of reference of the Corporate Social Responsibility Committee of our Company are as per Section 135 of the Companies Act, 2013 and the applicable rules thereunder.

IPO Committee

The members of the IPO Committee are:

1. Subramonia Sekhar Vasan, *Chairperson*;
2. Raunak Gupta; and
3. Muthuswami Lakshminarayan.

The IPO Committee was constituted by our Board of Directors on July 31, 2018. The IPO Committee has been authorized to approve and decide upon all activities in connection with the Offer, including, but not limited to, approving the Draft Red Herring Prospectus, Red Herring Prospectus and the Prospectus, to decide the terms and conditions of the Offer, to appoint various intermediaries, negotiating and executing Offer related agreements and to submit applications and documents to relevant statutory and other authorities from time to time.

Other committees of our Company

Except as disclosed in “*Our Management - Committees of the Board*” on page 201, we do not have any other committees.

Management Organisation Chart

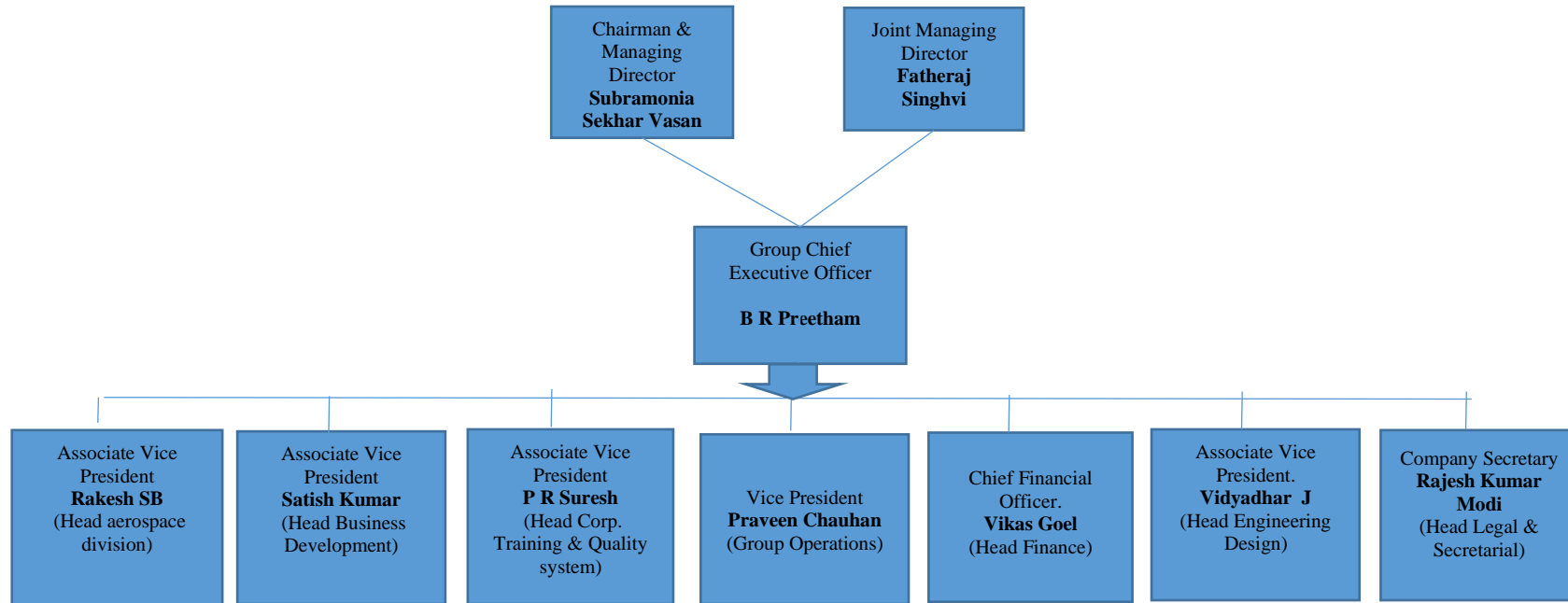

Key Managerial Personnel

The details of the Key Managerial Personnel of our Company, in addition to our Chairman and Managing Director, Subramonia Sekhar Vasan and Joint Managing Director Fatheraj Singhvi are as follows:

B R Preetham is the Group Chief Executive Officer of our Company and has been associated with our Company since September 28, 1992. He is the responsible for supervising the affairs of our Company and our Subsidiaries. He holds a bachelor's degree in engineering from Bangalore University. He has over 28 years of experience and has oversight across all areas of Company's business including developing and maintaining relationships with our companies and suppliers. During Fiscal 2021, he was paid a gross compensation of ₹11.47 million.

Vikas Goel is the Chief Financial Officer of our Company. He has been associated with our Company since July, 2019. He is responsible for supervising the affairs of the finance department of our Company. He is a fellow member of the Institute of Chartered Accountants of India. He is also an associate member of the Institute of Cost and Works Accountants of India. He holds a bachelor's degree in commerce from the University of Delhi. He has previously been associated with Ingersoll-Rand (India) Limited for two years, Stanley Black & Decker India Private Limited from November, 2013 up to June, 2017, and Weir India Private Limited from March, 2003 upto November, 2013. He has also previously worked at Motherson Sumi Systems Limited and Delton cables Limited. During Fiscal 2021, he was paid a gross compensation of ₹11.80 million.

Praveen Chauhan is the Vice President (Group) of our Company and has been associated with our Company since August 1, 2004. He is responsible for supervising the affairs of our Company's plant operations. He holds a diploma in automobile engineering from Board of Technical Education Delhi. He has over 35 years of experience in the field of engineering. Prior to joining our Company, he was associated with Maruti Udyog Limited. During Fiscal 2021, he was paid a gross compensation of ₹7.94 million.

Satish Kumar is the Associate Vice President of our Company and has been associated with our Company since September 27, 2004. He is responsible for supervising the affairs of business development our Company. He holds a bachelor's degree in engineering, specialising in mechanical engineering from Bangalore University. He has over 26 years of work experience in various fields including marketing, plant operation and management. Prior to joining our Company, he was associated with Kirloskar Oil Engines Limited. During Fiscal 2021, he was paid a gross compensation of ₹5.90 million.

P R Suresh is the Associate Vice President of our Company and has been associated with our Company since March 1, 1992. He is responsible for supervising the affairs of corporate training and quality systems department of our Company. He holds a bachelor's degree in engineering, specialising in mechanical engineering from University of Mysore and a master's degree in business administration from Indira Gandhi National Open University. He has undergone apprenticeship training for a year at HMT Limited, prior to joining our Company. He has over 28 years of experience in the fields of quality systems management. During Fiscal 2021, he was paid a gross compensation of ₹4.20 million.

Vidyadhar Janginamath is the Associate Vice President of our Company and has been associated with our Company since April 20, 2007. He is responsible for the engineering department of our Company. He holds a bachelor's degree in engineering, specialising in mechanical engineering from Karnataka University. He has over 28 years of experience in the field of product engineering and development. Prior to joining our Company, he was associated with Motor Industries Company Limited, Bajaj Auto Limited and Bharat Earth Movers Limited. During Fiscal 2021, he was paid a gross compensation of ₹4.01 million.

Rakesh S B is the Associate Vice President – Aerospace Division of our Company and has been associated with our Company since February 20, 2015. He is responsible for supervising the affairs of aerospace division of our Company. He holds a bachelor's degree in engineering, specialising in mechanical engineering from University of Mysore. He has over 19 years of work experience in various fields including sales, marketing and aerospace engineering. Prior to joining our Company, he was associated with Makino India Private Limited. During Fiscal 2021, he was paid a gross compensation of ₹4.27 million.

Rajesh Kumar Modi is the Company Secretary and Compliance Officer of our Company and has been associated with our Company since December 14, 2018. He holds a bachelor's degree in law from Barkatullah University, Bhopal. He is a member of the Institute of Company Secretaries of India. He also has a certificate of management training from the Steel Authority of India Limited. He has over 19 years of experience in the legal and secretarial field. He has previously worked at Infinite Computer Solutions (India) Limited for over two years, TCI Finance Limited for over four years, Claris Lifesciences Limited for over two years, Muscat Pharmacy and Stores LLC for over two years, Lilasons Breweries Limited for five years and Quess Corp Limited for six months. During Fiscal 2021, he was paid a gross compensation of ₹3.46 million.

Relationship between our Key Managerial Personnel and Key Managerial Personnel and Directors

None of the Key Managerial Personnel are related to each other or to any of the Directors of our Company.

All the Key Managerial Personnel are permanent employees of our Company.

Shareholding of Key Managerial Personnel

The details of Equity Shares held by our Key Managerial Personnel as of the date of this Red Herring Prospectus is as follows:

Name of Key Managerial Personnel	Number of Equity Shares	Pre- Offer Percentage Shareholding (%)
Subramonia Sekhar Vasan	12,307,600	23.96
Fatheraj Singhvi*	3,366,925	6.55

*Pursuant to the provisions of a memorandum of understanding executed between Fatheraj Singhvi and the Singhvi Family Shareholders, dated May 15, 2013, Fatheraj Singhvi is acting in trust in relation to 2,030,000 Equity Shares held by the Singhvi Family Shareholders.

Bonus or profit sharing plan of the Key Managerial Personnel

None of our Key Managerial Personnel is party to any bonus or profit sharing plan of our Company, other than the performance linked incentives given to Key Managerial Personnel.

Interests of Key Managerial Personnel

Our Key Managerial Personnel do not have any interest in our Company other than to the extent of the remuneration or benefits to which they are entitled as per their terms of appointment and reimbursement of expenses incurred by them during the ordinary course of business. The Key Managerial Personnel may also be deemed to be interested to the extent of any dividend payable to them and other distributions in respect of Equity Shares held in our Company, if any. Some of our Key Managerial Personnel are entitled to employee stock options and equity shares resulting from the exercise of options issued by our Company.

None of the Key Managerial Personnel have been paid any consideration of any nature from our Company other than their remuneration.

Further, there is no arrangement or understanding with the major shareholders, customers, suppliers or others, pursuant to which any Key Managerial Personnel was selected as member of senior management.

Changes in the Key Managerial Personnel

The changes in the Key Managerial Personnel in the last three years are as follows:

Name	Designation	Date of change	Reason for change
Vikas Goel	Chief Financial Officer	August 6, 2019	Appointed as the Chief Financial Officer of our Company
Fatheraj Singhvi	Chief Financial Officer	August 6, 2019	Resigned as the Chief Financial Officer of our Company
Fatheraj Singhvi	Chief Financial Officer	April 5, 2019	Appointed as the Chief Financial Officer of our Company
Rajesh Kumar Modi	Company Secretary and Compliance Officer	February 6, 2019	Appointed as the Company Secretary and Compliance Officer of our Company
Sourabh Kumar	Company Secretary and Compliance Officer	February 6, 2019	Resigned as the Company Secretary and Compliance Officer of our Company
Ramakrishnan S.	Group Chief Financial Officer	January 17, 2019	Resigned as the Group Chief Financial Officer

Service Contracts with Directors and Key Managerial Personnel

Other than statutory benefits upon termination of their employment in our Company on retirement, no officer of our Company, including our Directors and the Key Managerial Personnel has entered into a service contract with our Company pursuant to which they are entitled to any benefits upon termination of employment.

Contingent and deferred compensation payable to our Director and Key Managerial Personnel

As on the date of this Red Herring Prospectus, there is no contingent or deferred compensation payable to our Directors and KMPs, which does not form a part of their remuneration.

Payment or benefit to Key Managerial Personnel

Except an outstanding loan of ₹3.88 million as on Financial Year 2021, ₹ 3.88 million as on Financial Year 2020 and ₹ 2.88 million as on Financial Year 2019, which was extended to B R Preetham by our Company and as otherwise given in this section, no non-salary amount or benefit has been paid or given to any of our Company's officers including Key Managerial Personnel within the two preceding years or is intended to be paid or given as on the date of this Red Herring Prospectus.

Employee Stock Option Plans

For details in relation to ESOP 2015 and ESOP 2018 and options granted to our Directors and Key Managerial Personnel, see “*Capital Structure – ESOP 2015*” and “*Capital Structure – ESOP 2018*” on page 79 and 82, respectively.

OUR PROMOTERS AND PROMOTER GROUP

Subramonia Sekhar Vasan, Fatheraj Singhvi, Unni Rajagopal Kothenath and Devappa Devaraj are the Promoters of our Company and are in control of the day-to-day affairs of our Company. As of the date of this Red Herring Prospectus, our Promoters hold an aggregate of 21,839,200 Equity Shares, comprising 40.64% of the pre-Offer issued, subscribed and paid-up Equity Share capital (assuming exercise of vested employee stock options) of our Company. For details on shareholding of our Promoters in our Company, details of the Equity Shares held by Fatheraj Singhvi in trust for the Singhvi Family Shareholders, see “*Capital Structure – History of equity share capital held by our Promoters*” and “*History and Certain Corporate Matters – Summary of key agreements of our Company*” on pages 70 and 194, respectively.

The details of our Promoters are provided below:



Subramonia Sekhar Vasan

Subramonia Sekhar Vasan, aged 68 years, is our Chairman and Managing Director and is one of our Promoters. For further details in respect of his address, educational qualifications, experience, positions and posts held in the past, other directorships and special achievements, see “*Our Management*” on page 197.

Other than Vasan & Singhvi, partnership firm, Subramonia Sekhar Vasan is not involved in any other ventures.

His permanent account number is BJPPS4171P and his driving license number is KA05 1970000802. His Aadhar number is [REDACTED].



Fatheraj Singhvi

Fatheraj Singhvi, aged 66 years, is the Joint Managing Director and is one of our Promoters. For further details in respect of his address, educational qualifications, experience, positions and posts held in the past, other directorships and special achievements, see “*Our Management*” on page 197.

Other than Exdion Solutions Private Limited, Lankatiles Private Limited, Eff N Bee Hospitality Private Limited, Mulder (India) Private Limited, Eff N Bee Hiring Private Limited, S Premraj & Sons HUF, F.R. Singhvi & Sons, Praveen Singhvi HUF, Jayaraj Singhvi HUF, Vasan & Singhvi and P. Singhvi Charitable Trust, he is not involved in any other ventures.

His permanent account number is AGHPS5273J and his driving license number is KA05 19740001160. His Aadhar number is [REDACTED].



Unni Rajagopal Kothenath

Unni Rajagopal Kothenath, aged 67 years, is one of our Promoters. He resides at Tarawad, Palanahalli, Yelahanka, Bangalore North, Bengaluru 560 064, Karnataka, India. He holds a bachelor of arts degree from Bangalore University. He is a member of the Institute of Chartered Accountants of India since 1986. He was a partner at Singhvi, Dev & Unni, a chartered accountants’ partnership firm from 1981 to 2018. He has been associated with our Company since 1991.

Other than Unni Rajagopal HUF, he is not involved in any other ventures.

His permanent account number is ABGPR0823H and his driving license number is KA041985000877. His Aadhar number is [REDACTED].



Devappa Devaraj

Devappa Devaraj , aged 68 years, is one of our Promoters. He resides at 14, Ground Floor, Tpl Sepia CV Raman Road, Between Mekhri Circle Sadashivanagar Police Station, Rajamahal Vilas Extension, Sadashivanagar, Bengaluru North, Bengaluru 560 080, Karnataka, India. He is a member of the Institute of Chartered Accountant of India. He was a partner in Singhvi, Dev & Unni, a partnership firm engaged in the business of accounting from 1981 till 2018, when he retired from the partnership firm.

Other than N K Ventures, Rever Events, Rever Hospitalities, Devappa Devaraj HUF, Exdion Solutions Private Limited and Crossdomain Solutions Private Limited, he is not involved in any other ventures.

His permanent account number is AAJPD2185L and his driving license number is KA05 19720001550. His Aadhar number is [REDACTED].

Our Company confirms that the PAN, bank account numbers and passport numbers of our Promoters mentioned above have been submitted to the Stock Exchanges at the time of filing of the Draft Red Herring Prospectus with them.

Change in control of our Company

There has been no change in control or management of our Company in the last five years prior to the date of this Red Herring Prospectus.

Interest of our Promoters

Our Promoters are interested in our Company to the extent (i) that they are currently the Promoters of our Company, (ii) to the extent of their shareholding in the Company, the shareholding of their relatives and entities that they are interested in, in our Company and the dividend payable, if any and other distributions in respect of the Equity Shares held by them; (iii) to the extent of any remuneration, or reimbursement received by them from the Company or its Subsidiaries, in the capacity of Directors of our Company and our Subsidiaries; and (iv) payments made for services rendered by entities in which are Promoters have been interested in. For details on shareholding of our Promoters in our Company, see “*Capital Structure – History of the equity share capital held by our Promoters*”, “*History and Certain Corporate Matters*” and “*Our Management*” on pages 70, 188 and 197, respectively.

No sum has been paid or agreed to be paid to any of our Promoters or to the firms or companies in which our Promoters are interested as members in cash or shares or otherwise by any person, either to induce them to become or to qualify them, as directors or promoters or otherwise for services rendered by our Promoters or by such firms or companies in connection with the promotion or formation of our Company.

Interest of Promoters in the property of our Company

Except as disclosed in this section and the sections “*Other Financial Information – Related Party Transactions*” and “*Offer Document Summary*” on pages 280 and 14, respectively, our Promoters have no interest in any property acquired by or leased to our Company during the three years immediately preceding the date of this Red Herring Prospectus, or proposed to be acquired or leased to our Company. Further, none of the Promoters have any interest in any transaction by our Company for acquisition of land, construction of building or supply of machinery.

Payment of benefits to our Promoter or Promoter Group

Except as stated in this section, “*Our Management – Interest of Directors*”, and “*Financial Statements*” on pages 200 and 219, respectively, no amount or benefit has been paid or given to our Promoters or members of the Promoter Group during the two years preceding the filing of this Red Herring Prospectus nor is there any intention to pay or give any amount or benefit to our Promoters or members of the Promoter Group.

Material guarantees to third parties with respect to the Equity Shares

As on the date of this Red Herring Prospectus, our Promoters have not given any material guarantees to any third party with respect to the Equity Shares.

Companies or firms with which our Promoter has disassociated in the last three years

Except as set out below, our Promoters have not disassociated themselves from any company or firm in the three years immediately preceding the date of this Red Herring Prospectus.

Sr. No.	Name of Promoter	Name of entity	Reason for disassociation	Date of disassociation
1.	Devappa Devaraj	S D U and Co LLP	Retirement from the firm	January 10, 2019
2.	Unni Rajagopal Kothenath	S D U and Co LLP	Retirement from the firm	January 10, 2019

Promoter Group

Natural persons who are part of the Promoter Group

Name of Promoter	Name of relative	Relationship
Subramonia Sekhar Vasana	Manjula Sekhar	Spouse
	Manjula Balakrishnan	Sister
	Kishore S Iyer	Spouse's brother
Fatheraj Singhvi	Lalitha Singhvi	Spouse
	Chandrakala Bafna	Sister
	Suraj Kala Banthiya	Sister
	Manju Surana	Sister
	Praveen Singhvi	Brother
	Jayaraj Singhvi	Brother
	Bela Seth	Daughter
	Swetha Mithesh	Daughter
	Meera Singhvi	Daughter
	Vasanthi Parekh	Spouse's sister
	Kusum Kishorekumar Jain	Spouse's sister
	Prasan Kumar	Spouse's brother
Unni Rajagopal Kothenath	Tara Rajagopal	Spouse
	Ambika Sivaram	Sister
	K S Rajagopal	Brother
	Saikrishna Rajagopal	Brother
	Tarun Unni	Son
	Vikram Unni	Son
	Jyothi Madhavan	Spouse's sister
Devappa Devaraj	Bhagyalakshmi	Spouse
	Sharadamma	Mother
	Shridevi D	Sister
	Ranganath D	Brother
	Niveditha D	Daughter
	Namitha D	Daughter
	Savithramma	Spouse's mother
	B Bhaskar	Spouse's brother
	Banashankari	Spouse's sister
	Balamba	Spouse's sister
	Bhavani	Spouse's sister

Entities forming part of the Promoter Group

- D. Devaraj HUF;
- Eff N Bee Hiring Private Limited;
- Eff N Bee Hospitality Private Limited;
- F R Singhvi & Sons;
- Jayaraj Singhvi HUF;
- Lankatiles Private Limited;
- Mulder (India) Private Limited;
- N K Ventures;
- Praveen Singhvi HUF;

- P Singhvi Charitable Trust;
- S Premraj & Sons HUF
- Rever Events;
- Rever Hospitalities;
- Unni Rajagopal HUF; and
- Vasan & Singhvi, Firm

OUR GROUP COMPANIES

In terms of the SEBI ICDR Regulations and pursuant to the resolution passed by our Board at its meeting held on May 31, 2021, group companies of our Company shall include (i) the companies (other than the Promoters and Subsidiaries) with which there were related party transactions as per the Restated Consolidated Financial Information of the Company for Fiscals ended March 31, 2021, March 31, 2020 and March 31, 2019, and (ii) such other companies as considered material by the Board. For the purposes of (ii) above, the Board has approved that for the purposes of disclosure in connection with the Offer, there is no company considered material by the Board which shall be considered as a group company of the Company.

Accordingly, in terms of the policy adopted by our Board for determining group companies, our Board has identified Client Ebene Limited and CVCIGP II Employee Ebene Limited as the group companies of our Company (“**Group Companies**”).

Details of our Group Companies

1. Client Ebene Limited (“CEL”)

Corporate Information

Client Ebene Limited was incorporated as a private limited company on January 9, 2007 with the Registrar of Companies, Mauritius situated at Republic of Mauritius. The registered office of Client Ebene Limited is located at Sanne House, Bank Street, TwentyEight, Cybercity, Ebene 72201 Mauritius. The corporate identification number of Client Ebene Limited is 067 766 C1/GBL. Client Ebene Limited is registered as a foreign venture capital investor with the SEBI and its registration number is IN/FVCI/07-08/92

Nature of Activities

Client Ebene Limited is engaged in the business of investment holding as is authorized under its constitutional documents.

Financial Information

The financial information derived from the audited financial statements of Client Ebene Limited for the financial years ended December 31, 2020, 2019 and 2018 is set forth below:

Particulars	<i>(USD \$ in million except per share data)</i>		
	Financial year ended December 31 ⁽¹⁾		
	2020	2019	2018
Equity Capital	0.08	0.08	0.08
Reserves (Excluding Revaluation Reserve)	76.01	70.01	87.40
Sales/Income	6.00	-	-
Profit/(Loss) after Tax	5.97	(17.43)	(0.61)
Earnings per Share (Basic) (Face Value of \$1)	79.57	(232.45)	(8.14)
Earnings per Share (Diluted) (Face Value of \$1)	79.57	(232.45)	(8.14)
Net Asset Value ⁽²⁾	76.08	70.08	87.48

(1) Audited year ends on December 31 of each calendar year.

(2) Net asset value calculated by adding all the assets and subtracting external liabilities.

Significant notes of auditors of Client Ebene Limited for the last three financial years

There are no significant notes of auditors of Client Ebene Limited in relation to the aforementioned financial statements for the specified three immediately preceding financial years.

2. CVCIGP II Employee Ebene Limited (“EEL”)

Corporate Information

CVCIGP II Employee Ebene Limited was incorporated on January 9, 2007 under the Companies Act, 2001 with the Registrar of Companies, Mauritius situated at Port Louis. The registered office of CVCIGP II Employee Ebene Limited is located at Sanne House, Bank Street, TwentyEight, cybercity, Ebene 72201, Mauritius. The corporate identification number of CVCIGP II Employee Ebene Limited is 067 767 C1/GBL. CVCIGP II Employee Ebene Limited is registered as a foreign venture capital investor with Securities and Exchange Board of India and its registration number is IN/FVCI/07-08/91

Nature of Activities

CVCIGP II Employee Ebene Limited is engaged in the business of investment holding as is authorized under its constitutional

documents.

Financial Information

The financial information derived from the audited financial statements of CVCIGP II Employee Ebene Limited for the financial years ended December 31, 2020, 2019 and 2018 is set forth below:

(USD \$in million except per share data)

Particulars	Financial year ended December 31 ⁽¹⁾		
	2020	2019	2018
Equity Capital	0.08	0.08	0.08
Reserves (Excluding Revaluation Reserve)	42.54	39.18	48.91
Sales/Income	3.36	-	-
Profit/(Loss) after Tax	3.32	(9.79)	(0.36)
Earnings per Share (Basic) (Face Value of \$1)	44.30	(130.54)	(4.78)
Earnings per Share (Diluted) (Face Value of \$1)	44.30	(130.54)	(4.78)
Net Asset Value ⁽²⁾	42.61	39.26	48.98

(1) Audited year ends on December 31 of each calendar year

(2) Net asset value calculated by adding all the assets and subtracting external liabilities

Significant notes of auditors of CVCIGP II Employee Ebene Limited for the last three financial years

There are no significant notes of auditors of CVCIGP II Employee Ebene Limited in relation to the aforementioned financial statements for the specified three immediately preceding financial years.

Loss making Group Companies

Details of the profits/ (losses) made by our Group Companies in the last three Financial Years is as follows:

(USD \$in million)

Group Company	Financial year ended December 31 ⁽¹⁾		
	2020	2019	2018
Client Ebene Limited	5.97	(17.43)	(0.61)
CVCIGP II Employee Ebene Limited	3.32	(9.79)	(0.36)

(1) Audited year ends on December 31 of each calendar year

Nature and extent of interest of our Group Companies

a. In the promotion of our Company

Our Group Companies do not have any interest in the promotion of our Company.

b. In the properties acquired by us in the preceding three years before filing this Red Herring Prospectus or proposed to be acquired by our Company

Our Group Companies are not interested in the properties acquired by us in the three years preceding the filing of this Red Herring Prospectus or proposed to be acquired by us as on the date of this Red Herring Prospectus.

c. In transactions for acquisition of land, construction of building and supply of machinery

Our Group Companies are not interested in any transactions for the acquisition of land, construction of building or supply of machinery.

Defunct Group Companies

Our Group Companies are not defunct and no applications have been made to the relevant registrar of companies for striking off their names during the five years preceding the date of filing of this Red Herring Prospectus with SEBI.

Group Companies which are a sick industrial company or are under winding up/ insolvency proceedings

Our Group Companies do not fall under the definition of sick companies under the erstwhile Sick Industrial Companies (Special Provisions) Act, 1985 and are not under any winding up or insolvency proceedings under applicable law.

Common Pursuits between our Group Companies and our Company

There are no common pursuits between our Group Companies and our Company.

Related business transactions with the Group Companies and significance on the financial performance of our Company

Other than the transactions disclosed in “*Other Financial Information – Related Party Transactions*” on page 280, there are no other related business transactions with our Group Companies.

Business interest of our Group Companies in our Company

Except as disclosed in “*Other Financial Information – Related Party Transactions*” on page 280, our Group Companies do not have any business interest in our Company

Litigation

Our Group Companies are not party to any pending litigations which will have a material impact on our Company.

Other confirmations

The equity shares of our Group Companies are not listed on any stock exchange.

None of our Group Companies have made any public or rights issue of securities in the preceding three years.

DIVIDEND POLICY

The declaration and payment of dividends is recommended by the Board of Directors and approved by the Shareholders, at their discretion, subject to the provisions of the, Articles of Association of our Company, Companies Act and other applicable law. The dividend, if any, will depend on a number of factors, including but not limited to the earnings, capital requirements, contractual obligations, applicable legal restrictions and overall financial position of our Company and other factors considered relevant by our Board. We may retain all our future earnings, if any, for use in the operations and expansion of our business. As on the date of this Red Herring Prospectus, our Company has no formal dividend policy. For further details, see “*Risk Factors – We cannot assure payment of dividends on the Equity Shares in the future*” on page 45.

In addition, our ability to pay dividends may be impacted by a number of factors, including restrictive covenants under the loan or financing arrangements our Company is currently availing of or may enter into to finance our fund requirements for our business activities. For further details, see “*Financial Indebtedness*” on page 313.

We have not declared any dividends in the three Fiscals immediately preceding the filing of this Red Herring Prospectus or during the period between March 31, 2021 up to the date of filing this Red Herring Prospectus.

SECTION V: FINANCIAL INFORMATION

FINANCIAL STATEMENTS

[The remainder of this page has been intentionally left blank.]

INDEPENDENT AUDITOR'S EXAMINATION REPORT ON RESTATED CONSOLIDATED FINANCIAL INFORMATION

The Board of Directors

Sansera Engineering Limited (formerly known as "Sansera Engineering Private Limited")

Plant-7, No.143/A, Jigani Link Road,
Bommasandra Industrial Area,
Anekal Taluk,
Bengaluru - 560105

Dear Sirs,

1. We have examined, as appropriate (refer paragraph 5, 6 and 7 below), the attached Restated Consolidated Financial Information of Sansera Engineering Limited (formerly known as Sansera Engineering Private Limited) (the "Company") and its subsidiaries (the Company and its subsidiaries together referred to as the "Group"), comprising the Restated Consolidated Statement of Assets and Liabilities as at March 31, 2021, 2020 and 2019, the Restated Consolidated Statements of Profit and Loss (including other comprehensive income), the Restated Consolidated Statement of Cash Flows, the Restated Consolidated Statement of Changes in Equity for the years ended March 31, 2021, 2020 and 2019, the Summary Statement of Significant Accounting Policies, and other explanatory information (collectively, the "Restated Consolidated Financial Information"), as approved by the Board of Directors of the Company at their meeting held on September 6, 2021 for the purpose of inclusion in the Red Herring Prospectus ("RHP") and Prospectus (RHP and Prospectus collectively referred as the "Offer Documents") to be prepared by the Company in connection with the proposed initial public offer of equity shares ("IPO"), prepared in terms of the requirements of:
 - a) Section 26 of Part I of Chapter III of the Companies Act, 2013, as amended (the "Act");
 - b) The Securities and Exchange Board of India (Issue of Capital and Disclosure Requirements) Regulations, 2018, as amended ("ICDR Regulations"); and
 - c) The Guidance Note on Reports in Company Prospectuses (Revised 2019) issued by the Institute of Chartered Accountants of India ("ICAI"), as amended (the "Guidance Note").
2. The Company's Board of Directors is responsible for the preparation of the Restated Consolidated Financial Information for the purpose of inclusion in the Offer Documents to be filed with Securities and Exchange Board of India, in connection with the proposed IPO. The Restated Consolidated Financial Information have been prepared by the management of the Company on the basis of preparation stated in note 1 to the Restated Consolidated Financial Information. The respective Board of Directors of the companies included in the Group responsibilities include designing, implementing and maintaining adequate internal control relevant to the preparation and presentation of the Restated Consolidated Financial Information. The respective Board of Directors are also responsible for identifying and ensuring that the Group complies with the Act, ICDR Regulations and the Guidance Note.
3. We have examined such Restated Consolidated Financial Information taking into consideration:
 - a) The terms of reference and terms of our engagement agreed upon with you in accordance with our engagement letter dated April 29, 2021 in connection with the proposed IPO of equity shares of the Company;
 - b) The Guidance Note. The Guidance Note also requires that we comply with the ethical requirements of the Code of Ethics issued by the ICAI;
 - c) Concepts of test checks and materiality to obtain reasonable assurance based on verification of evidence supporting the Restated Consolidated Financial Information; and

- d) The requirements of Section 26 of the Act and the ICDR Regulations. Our work was performed solely to assist you in meeting your responsibilities in relation to your compliance with the Act, the ICDR Regulations and the Guidance Note in connection with the IPO.
4. The Restated Consolidated Financial Information have been compiled by the management from audited consolidated Ind AS financial statements of the Group as at and for the years ended March 31, 2021, 2020 and 2019, prepared in accordance with the Indian Accounting Standards (referred to as "Ind AS") as prescribed under Section 133 of the Act read with Companies (Indian Accounting Standards) Rules 2015, as amended, and other accounting principles generally accepted in India, which have been approved by the Board of Directors at their meeting held on April 19, 2021, November 23, 2020 and August 6, 2019 respectively.
5. For the purpose of our examination, we have relied on:
- a) Auditors' reports issued by us dated April 19, 2021 on the consolidated Ind AS financial statements of the Group as at and for the year ended March 31, 2021, as referred in Paragraph 4 above; and
- b) Auditors' Report issued by the Company's previous auditors, BSR & Associates LLP (ICAI FRN: 116231W/W-100024) ("the Previous Auditors"), dated November 23, 2020 and August 6, 2019 on the consolidated Ind AS financial statements of the Group as at and for the years ended March 31, 2020 and 2019, as referred in Paragraph 4 above.

The audits for the financial years ended March 31, 2020 and 2019 were conducted by the Previous Auditors, and accordingly reliance has been placed on the restated consolidated statement of assets and liabilities and the restated consolidated statements of profit and loss (including other comprehensive income), restated statements of cash flow and statement of changes in equity, the Summary Statement of Significant Accounting Policies, and other explanatory information and (collectively, the "2020 and 2019 Restated Consolidated Financial Information") examined by them for the said years. The examination report in so far as it relates to the said years is based solely on the examination report submitted by the Previous Auditors. They have also confirmed that the 2020 and 2019 Restated Consolidated Financial Information:

- i. have been prepared after incorporating adjustments for the changes in accounting policies, material errors and regrouping/reclassifications retrospectively in the financial year ended March 31, 2020 and 2019 to reflect the same accounting treatment as per the accounting policies and grouping/classifications followed as at and for the year ended March 31, 2021;
- ii. do not require any adjustment for modification as there is no modification in the underlying audit reports; and
- iii. have been prepared in accordance with the Act, ICDR Regulations and the Guidance Note.

6. As indicated in our audit reports referred in paragraph 5(a) above:

- a) we did not audit financial statements of 2 subsidiaries whose share of total assets, total revenues, net cash inflows included in the consolidated Ind AS financial statements, as at and for the year ended March 31, 2021 is tabulated below, which have been audited by other auditors, and whose reports have been furnished to us by the Company's management and our opinion on the consolidated Ind AS financial statements, in so far as it relates to the amounts and disclosures included in respect of these components, is based solely on the reports of the other auditors:

(Rs. in million)

Particulars	As at / for the year ended March 31, 2021
Total assets	2,497.77
Total revenue	1,388.97
Net cash inflows	176.41

Our opinion on the consolidated Ind AS financial statements is not modified in respect of these matters.

7. Based on examination report dated May 31, 2021 provided by the Previous Auditors, the audit reports on the consolidated Ind AS financial statements issued by the Previous Auditors included following other matters:

- a) we did not audit the financial statements of two subsidiaries of the group for the year ended 31 March 2020 and 31 March 2019, whose share of total assets (before consolidation adjustments), total revenues (before consolidation adjustments) and net cash flows (before consolidation adjustments), included in the audited consolidated Ind AS financial statements of the group for each of the financial years, are tabulated below:

(Rs in million)

Particulars	As at / for the year ended March 31, 2020	As at / for the year ended March 31, 2019
Total assets	2,244.06	1,555.45
Total revenues	1,400.84	1,659.84
Net cash inflows / (outflows)	4.33	(9.55)

These financial statements of two subsidiaries have been audited by other auditors whose reports have been furnished to us by the Company's management and our audit opinion on the consolidated Ind AS financial statements for the relevant years, insofar as it relates to the amounts and disclosures included in respect of these subsidiaries, are based solely on the reports of the other auditors and in case of one subsidiary the conversion adjustments prepared by the Management of the Holding Company and audited by us.

Our opinion on the consolidated Ind AS financial statements is not modified in respect of these matters.

8. Based on our examination and according to the information and explanations given to us and also as per the reliance placed on the examination report submitted by the Previous Auditors for the respective years, we report that the Restated Consolidated Financial Information:

- a) have been prepared after incorporating adjustments for the changes in accounting policies, material errors and regrouping/reclassifications retrospectively in the financial years ended March 31, 2020 and 2019 to reflect the same accounting treatment as per the accounting policies and grouping/classifications followed as at and for the year ended March 31, 2021;

- b) do not require any adjustment for modification as there is no modification in the underlying audit reports; and
 - c) have been prepared in accordance with the Act, ICDR Regulations and the Guidance Note.
9. We have complied with the relevant applicable requirements of the Standard on Quality Control (SQC) 1, Quality Control for Firms that Perform Audits and Reviews of Historical Financial Information, and Other Assurance and Related Services Engagements.
 10. The Restated Consolidated Financial Information do not reflect the effects of events that occurred subsequent to the respective dates of the reports on the consolidated Ind AS financial statements mentioned in paragraph 4 above.
 11. This report should not in any way be construed as a reissuance or re-dating of any of the previous audit reports issued by us or the Previous Auditors, nor should this report be construed as a new opinion on any of the financial statements referred to herein.
 12. We have no responsibility to update our report for events and circumstances occurring after the date of the report.
 13. Our report is intended solely for use of the Board of Directors for inclusion in the Offer Documents to be filed with Securities and Exchange Board of India in connection with the proposed IPO. Our report should not be used, referred to, or distributed for any other purpose except with our prior consent in writing. Accordingly, we do not accept or assume any liability or any duty of care for any other purpose or to any other person to whom this report is shown or into whose hands it may come without our prior consent in writing.

For **Deloitte Haskins & Sells**
Chartered Accountants
(Firm's Registration No: 008072S)

Monisha Parikh
(Partner)
(Membership Number: 47840)
UDIN: 21047840AAAADU8905

Place: Ahmedabad
Date: September 6, 2021

Sansera Engineering Limited (formerly known as Sansera Engineering Private Limited)
Restated Consolidated Statement of Assets and Liabilities

(Amount in ₹ millions)

Particulars	Notes	As at		
		31 March 2021	31 March 2020	31 March 2019
ASSETS				
Non-current assets				
Property, Plant and Equipment	3 (a)	10,000.05	9,421.31	8,890.71
Capital work-in-progress		604.23	683.35	488.55
Goodwill	4	358.37	323.64	324.21
Other intangible assets	3 (b)	19.17	25.72	32.54
Right-of-use-asset	3 (c)	892.35	872.97	896.57
Financial assets				
(i) Investments	5	36.93	36.93	-
(ii) Loans	6	284.54	267.10	257.32
(iii) Other financial assets	7	14.09	34.81	34.24
Tax assets for current taxes (net)	8 (a)	27.14	29.30	62.48
Other non-current assets	9	224.70	204.68	227.03
Total non-current assets		12,461.57	11,899.81	11,213.65
Current assets				
Inventories	10	2,485.69	2,389.18	2,434.59
Financial assets				
(i) Investments	11	5.58	3.53	5.34
(ii) Trade receivables	12	3,129.83	2,591.21	2,712.43
(iii) Cash and cash equivalents	13	365.00	600.08	239.27
(iv) Bank balances other than cash and cash equivalents	14	286.42	116.36	76.73
(v) Other financial assets	15	222.81	236.47	256.46
Other current assets	16	331.93	445.72	516.37
Total current assets		6,827.26	6,382.55	6,241.19
Total assets		19,288.83	18,282.36	17,454.84
EQUITY AND LIABILITIES				
Equity				
Equity share capital	17 (a)	93.87	93.87	93.87
Instruments entirely equity in nature	17 (b)	105.00	105.00	105.00
Other equity	18	8,583.55	7,482.91	6,654.95
Total equity attributable to owners of the company		8,782.42	7,681.78	6,853.82
Non-controlling Interests		104.99	86.78	91.36
Total equity		8,887.41	7,768.56	6,945.18
Liabilities				
Non-Current Liabilities				
Financial liabilities				
(i) Non-current borrowings	19	1,876.52	1,718.25	2,133.84
(ii) Lease liabilities	3 (c)	810.28	788.59	805.71
(iii) Other financial liabilities	20	-	11.04	76.87
Non-current provision	21	151.83	126.89	85.83
Deferred tax liabilities (net)	22	617.98	552.27	702.98
Other non-current liabilities	23	467.16	425.89	421.34
Total non-current liabilities		3,923.77	3,622.93	4,226.57
Current liabilities				
Financial Liabilities				
(i) Current borrowings	24	2,552.32	3,554.12	3,043.08
(ii) Lease liabilities	3 (c)	110.88	96.94	86.48
(iii) Trade payables	25			
- Total outstanding dues of micro enterprises and small enterprises		86.39	67.23	91.18
- Total outstanding dues of creditors other than micro enterprises and small enterprises		2,184.07	1,661.72	1,774.46
(iv) Other financial liabilities	26	1,236.67	1,218.31	1,002.36
Current tax liabilities (net)	8 (b)	0.59	29.52	82.51
Other current liabilities	28	207.63	164.49	137.60
Current provisions	27	99.10	98.54	65.42
Total current liabilities		6,477.65	6,890.87	6,283.09
Total equity and liabilities		19,288.83	18,282.36	17,454.84

The accompanying notes 1 to 57 are an integral part of the restated consolidated financial information.

As per our report of even date attached:

for **Deloitte Haskins & Sells**
Chartered Accountants
Firm's Registration No: 008072S

for **Sansera Engineering Limited (formerly known as Sansera Engineering Private Limited)**
CIN: U34103KA1981PTC004542

Monisha Parikh
Partner
Membership No. 47840

S Sekhar Vasani
Chairman and Managing Director
DIN: 00361245

F.R Singhvi
Joint Managing Director
DIN: 00233146

B R Preetham
Chief Executive Officer

Vikas Goel
Chief Financial Officer

Rajesh Kumar Modi
Company Secretary

Place: Ahmedabad
Date: 6 September 2021

Place: Bengaluru
Date: 6 September 2021

Sansera Engineering Limited (formerly known as Sansera Engineering Private Limited)
Restated Consolidated Statement of Profit and Loss

(Amount in ₹ millions)

Particulars	Notes	For the year ended 31 March 2021	For the year ended 31 March 2020	For the year ended 31 March 2019
Revenue				
Revenue from operations	29	15,492.71	14,571.70	16,244.30
Other income	30	230.93	159.69	163.79
Total income		15,723.64	14,731.39	16,408.09
Expenses				
Cost of material consumed	31	6,678.31	6,281.99	7,220.02
Changes in inventory of finished goods and work in progress	32	(43.71)	(18.95)	(167.01)
Conversion charges		526.15	486.79	468.80
Consumption of stores and spares		1,335.80	1,310.76	1,506.32
Power and fuel		670.65	750.55	841.31
Employee benefit expenses	33	2,137.50	2,134.24	2,174.07
Finance costs	34	473.93	580.90	512.81
Depreciation and amortisation expense	35	1,016.76	939.00	757.54
Other expenses	36	1,466.80	1,379.35	1,309.82
Total expenses		14,262.19	13,844.63	14,623.68
Profit before exceptional items and tax		1,461.45	886.76	1,784.41
Exceptional items		-	-	134.90
Profit before tax		1,461.45	886.76	1,649.51
Tax expenses:	40			
Current tax		303.87	235.05	492.55
Deferred tax (credit)/charge		58.98	(147.34)	176.32
Total tax expenses		362.85	87.71	668.87
Profit for the year		1,098.60	799.05	980.64
Other comprehensive income/(expense)				
<i>Items that will not be reclassified to profit or loss</i>				
Re-measurement of the net defined benefit liability		(25.94)	(13.16)	(2.95)
Income tax relating to items that will not be reclassified to profit and loss		6.59	3.37	1.02
Net other comprehensive income/(expense)	42	(19.35)	(9.79)	(1.93)
<i>Items that will be reclassified subsequently to profit or loss</i>				
Exchange differences on translation of foreign operations		52.92	34.12	(31.85)
Income tax relating to items that will be reclassified to profit and loss		(13.32)	-	-
Net other comprehensive income/(expense)		39.60	34.12	(31.85)
Other comprehensive income/(expense) for the year, net of income tax		20.25	24.33	(33.78)
Total comprehensive income for the year, net of tax		1,118.85	823.38	946.86
Profit attributable to :				
Owners of the Company		1,079.86	803.10	962.13
Non-controlling interests		18.74	(4.05)	18.51
Profit for the year		1,098.60	799.05	980.64
Other comprehensive income attributable to:				
Owners of the Company		20.78	24.86	(33.71)
Non-controlling interests		(0.53)	(0.53)	(0.07)
Total other comprehensive income		20.25	24.33	(33.78)
Total comprehensive income attributable to:				
Owners of the Company		1,100.64	827.96	928.42
Non-controlling interests		18.21	(4.58)	18.44
Total comprehensive income, net of tax		1,118.85	823.38	946.86
Earnings per equity share (face value of ₹ 2 each)				
Basic (in ₹)	37	21.02	15.63	18.73
Diluted (in ₹)	37	20.55	15.28	18.31

The accompanying notes 1 to 57 are an integral part of the restated consolidated financial information.

As per our report of even date attached:

for Deloitte Haskins & Sells
Chartered Accountants
Firm's Registration No: 008072S

Monisha Parikh
Partner
Membership No. 47840

for Sansera Engineering Limited (formerly known as Sansera Engineering Private Limited)
CIN: U34103KA1981PTC004542

S Sekhar Vasani
Chairman and Managing Director
DIN: 00361245

F.R Singhvi
Joint Managing Director
DIN: 00233146

B R Preetham
Chief Executive Officer

Vikas Goel
Chief Financial Officer

Rajesh Kumar Modi
Company Secretary

Place: Ahmedabad
Date: 6 September 2021

Place: Bengaluru
Date: 6 September 2021

Sansera Engineering Limited (formerly known as Sansera Engineering Private Limited)
Restated Consolidated Cash Flow Statement

Particulars	(Amount in ₹ millions)		
	For the year ended 31 March 2021	For the year ended 31 March 2020	For the year ended 31 March 2019
Cash flows from operating activities			
Profit before tax from continuing operations	1,461.45	886.76	1,649.51
Adjustments to reconcile profit before tax to net cash flows:			
Depreciation and amortisation expense	1,016.76	939.00	757.54
Interest income	(22.42)	(10.87)	(5.77)
Income from government grants	(45.11)	(40.89)	(25.05)
Adjustment for rental concession	(2.71)	-	-
(Profit)/ loss on sale of property, plant and equipments, net	(4.77)	(1.05)	2.51
Unrealised foreign exchange gain, net	(49.45)	45.06	24.58
Employee stock compensation expense	-	-	4.47
Loss allowance on trade receivables	-	-	0.50
Insurance claim receivable written off	11.26	10.50	9.23
Finance cost	473.93	580.90	512.81
Adjustment on fair value gain of investments	(2.05)	-	-
Other non-operating income	-	-	(14.24)
	2,836.89	2,409.41	2,916.09
Working capital adjustments			
Changes in trade receivables	(442.92)	206.27	(55.01)
Other current and non-current assets and current financial assets	41.02	59.86	(55.44)
Changes in inventory	(96.51)	45.41	(353.70)
Changes in trade payables and financial liabilities	527.14	(136.57)	35.06
Other liabilities and provisions	25.37	82.58	112.49
Cash generated from operations	2,890.99	2,666.96	2,599.49
Income taxes paid, net	(330.64)	(254.86)	(414.95)
Net cash generated from operating activities (A)	2,560.35	2,412.10	2,184.54
Cash flows from investing activities			
Purchase of property, plant and equipments	(1,351.21)	(1,767.17)	(2,381.33)
Proceeds from sale of property, plant and equipments	11.52	27.33	0.78
Receipt of government grant	92.67	37.16	-
Investments made, net	-	(36.93)	-
Interest received	22.42	10.87	5.77
Movement in fixed deposit, net	(170.06)	(42.14)	(1.28)
Net cash used in investing activities (B)	(1,394.66)	(1,770.88)	(2,376.06)
Cash flows from financing activities			
Proceeds/(repayment) of non-current borrowings:			
Proceeds	1,099.93	809.50	1,255.20
Repayment	(979.92)	(951.69)	(710.20)
Proceeds of current borrowings, net	(992.26)	490.64	148.80
Interest paid	(459.00)	(580.90)	(512.81)
Payment of principal portion of lease liabilities	(60.75)	(56.75)	(36.26)
Net cash (used in)/generated from financing activities (C)	(1,392.00)	(289.19)	144.73
Cash and cash equivalents at the beginning of the year	600.08	239.27	343.37
Effect of exchange differences on translation of foreign currency cash and cash equivalents	(8.77)	8.78	(55.95)
Net increase/(decrease) in cash and cash equivalents	(226.31)	352.03	(48.15)
Cash and cash equivalents at the end of the year (refer below)	365.00	600.08	239.27
For the purpose of statement of cash flows, cash and cash equivalents comprise the following:			
Cash on hand	0.72	1.14	1.00
Balances with banks			
- on current accounts	364.28	598.94	238.27
	365.00	600.08	239.27

The accompanying notes 1 to 57 are an integral part of the restated consolidated financial information.

Sansera Engineering Limited

for **Deloitte Haskins & Sells**
Chartered Accountants
Firm's Registration No: 008072S

Monisha Parikh
Partner
Membership No. 47840

for **Sansera Engineering Limited (formerly known as Sansera Engineering Private Limited)**

CIN: U34103KA1981PTC004542

S Sekhar Vasan
Chairman and Managing Director
DIN: 00361245

F.R Singhvi
Joint Managing Director
DIN: 00233146

B R Preetham
Chief Executive Officer

Vikas Goel
Chief Financial Officer

Rajesh Kumar Modi
Company Secretary

Place: Ahmedabad
Date: 6 September 2021

Place: Bengaluru
Date: 6 September 2021

Sansera Engineering Limited (formerly known as Sansera Engineering Private Limited)
Restated Consolidated Statement of Changes in Equity

A. Equity share capital

	No. of shares	Amount in ₹ millions
Equity shares		
Balance as at 1 April 2018	64,740	6.47
Changes in share capital (refer note 17(a)(ii)(a))	46,871,760	87.40
Balance as at 31 March 2019	46,936,500	93.87
Balance as at 31 March 2020	46,936,500	93.87
Balance as at 31 March 2021	46,936,500	93.87

B. Instruments entirely equity in nature

Compulsorily Convertible Preference Shares	No. of shares	Amount in ₹ millions
A Series, 0.0001% compulsorily convertible preference shares of ₹100 each	300,000	30.00
B Series, 0.0001% compulsorily convertible preference shares of ₹100 each	750,000	75.00
Balance as at 31 March 2019	1,050,000	105.00
Balance as at 31 March 2020	1,050,000	105.00
Balance as at 31 March 2021	1,050,000	105.00

C. Other equity

Particulars	Reserves and Surplus					Employee stock option outstanding account	Other comprehensive income		Attributable to owners of the parent	Non-controlling interest	Total
	Capital redemption reserve	Capital reserve	Securities premium	General reserve	Retained earnings		Foreign currency translation reserve	Remeasurements of actuarial gain and losses			
Balance as at 31 March 2018	0.55	8.17	1,216.76	135.48	4,275.92	177.53	11.37	-	5,825.78	72.92	5,898.70
Impact on account of adoption of Ind AS 116 (Refer note 3 (c) and note 55)	-	-	-	-	(16.32)	-	-	-	(16.32)	-	(16.32)
Balance as at 1 April 2018 (Restated - Refer note 55)	0.55	8.17	1,216.76	135.48	4,259.60	177.53	11.37	-	5,809.46	72.92	5,882.38
Profit for the year (Refer note 55)	-	-	-	-	962.13	-	-	-	962.13	18.51	980.64
Remeasurement of the net defined benefit liability	-	-	-	-	-	-	-	(1.86)	(1.86)	-	(1.86)
Transfer to retained earnings	-	-	-	-	(1.86)	-	-	1.86	-	(0.07)	(0.07)
Exchange differences on translation of foreign operations	-	-	-	-	-	-	(31.85)	-	(31.85)	-	(31.85)
Compensation expense for options granted during the year (Refer to note 43)	-	-	-	-	-	4.47	-	-	4.47	-	4.47
Bonus issue of equity shares (Refer Note 17(a))	-	-	-	-	(87.40)	-	-	-	(87.40)	-	(87.40)
Balance as at 31 March 2019	0.55	8.17	1,216.76	135.48	5,132.47	182.00	(20.48)	-	6,654.95	91.36	6,746.31
Profit for the year (Refer note 55)	-	-	-	-	803.10	-	-	-	803.10	(4.05)	799.05
Remeasurement of the net defined benefit liability	-	-	-	-	-	-	-	(9.26)	(9.26)	-	(9.26)
Transfer to retained earnings	-	-	-	-	(9.26)	-	-	9.26	-	(0.53)	(0.53)
Exchange differences on translation of foreign operations	-	-	-	-	-	-	34.12	-	34.12	-	34.12
Balance as at 31 March 2020	0.55	8.17	1,216.76	135.48	5,926.31	182.00	13.64	-	7,482.91	86.78	7,569.69
Profit for the year	-	-	-	-	1,079.86	-	-	-	1,079.86	18.74	1,098.60
Remeasurement of the net defined benefit liability	-	-	-	-	-	-	-	(18.82)	(18.82)	-	(18.82)
Transfer to retained earnings	-	-	-	-	(18.82)	-	-	18.82	-	(0.53)	(0.53)
Exchange differences on translation of foreign operations	-	-	-	-	-	-	39.60	-	39.60	-	39.60
Balance as at 31 March 2021	0.55	8.17	1,216.76	135.48	6,987.35	182.00	53.24	-	8,583.55	104.99	8,688.54

The accompanying notes 1 to 57 are an integral part of the restated consolidated financial information.

As per our report of even date attached:

for **Deloitte Haskins & Sells**

Chartered Accountants

Firm's Registration No: 008072S

for **Sansera Engineering Limited (formerly known as Sansera Engineering Private Limited)**

CIN: U34103KA198IPTC004542

Monisha Parikh

Partner

Membership No. 47840

S Sekhar Vasan

Chairman and Managing Director

DIN: 00361245

F.R Singhvi

Joint Managing Director

DIN: 00233146

B R Preetham

Chief Executive Officer

Vikas Goel

Chief Financial Officer

Rajesh Kumar Modi

Company Secretary

Place: Ahmedabad

Date: 6 September 2021

Place: Bengaluru

Date: 6 September 2021

**Sansera Engineering Limited (erstwhile Sansera Engineering Private Limited)
Notes to the Restated Consolidated Financial Information**

Group Overview

Sansera Engineering Limited (“the Company”) (erstwhile Sansera Engineering Private Limited) along with its subsidiaries Fitwel Tools and Forgings Private Limited, Sansera Sweden AB and Sansera Engineering Pvt. Ltd. Mauritius is collectively referred to as “Group”. The Company was incorporated on 15 December 1981 under the provisions of the Companies Act, 1956 with its registered office in Bangalore, Karnataka. The Group is involved in the business of manufacture of auto components such as rocker arms, connecting rods, gear shifter forks, crankshafts, and aerospace components. It is also involved in providing services such as forging and other related services.

The Company is a public limited company incorporated and domiciled in India and has its registered office at Bengaluru, Karnataka, India and has offices in Sweden.

1. Basis of preparation

a. Statement of compliance

The Restated Consolidated Financial Information of the Group comprises of the Restated Consolidated Statement of Assets and Liabilities as at 31 March 2021, 31 March 2020 and 31 March 2019, the Restated Consolidated Statement of Profit and Loss (including Other Comprehensive Income), the Restated Consolidated Statement of Cash Flows and the Restated Consolidated Statement of Changes in Equity for years ended 31 March 2021, 31 March 2020 and 31 March 2019 and the Summary of Significant Accounting Policies and explanatory notes and notes to restated consolidated financial information (collectively, the ‘Restated Consolidated Financial Information’).

These Restated Consolidated Financial Information have been prepared by the Management of the Company for the purpose of inclusion in the Draft Red Herring Prospectus (‘DRHP’) prepared by the Company in connection with its proposed Initial Public Offer (“IPO”) in terms of the requirements of:

- a) Section 26 of Part I of Chapter III of the Companies Act, 2013 (“the Act”);
- b) The Securities and Exchange Board of India (Issue of Capital and Disclosure Requirements) Regulations, 2018, as amended (“ICDR Regulations”); and
- c) The Guidance Note on Reports in Company Prospectuses (Revised 2019) issued by the Institute of Chartered Accountants of India (ICAI), as amended (the “Guidance Note”).

These Restated Consolidated Financial Information have been compiled by the Management from:

- a) audited consolidated Ind AS financial statements of the Group for the years ended 31 March 2021, 31 March 2020 and 31 March 2019 prepared in accordance with the Indian Accounting Standards (referred to as “Ind AS”) as prescribed under Section 133 of the Act read with Companies (Indian Accounting Standards) Rules 2015, as amended, and other accounting principles generally accepted in India, which have been approved by the Board of Directors of the Company at their meetings held on 19th April 2021, 23 November 2020 and 6 August 2019 respectively.

The accounting policies have been consistently applied by the Company in preparation of the Restated Consolidated Financial Information and are consistent with those adopted in the preparation of financial statements for the year ended 31 March 2021. These Restated Consolidated Financial Information do not reflect the effects of events that occurred subsequent to the respective dates of board meeting on the audited consolidated Ind AS Financial Statements mentioned above, refer Note 37.

The Restated Consolidated Financial Information:

- a) have been prepared after incorporating adjustments for the changes in accounting policies, material errors and regrouping/reclassifications retrospectively in the financial years ended 31 March 2020, and 2019 to reflect the same accounting treatment as per the accounting policy and grouping/classifications followed as at and for the year ended 31 March 2021.
- b) do not require any adjustment for modification as there is no modification in the underlying audit reports.

Sansera Engineering Limited (erstwhile Sansera Engineering Private Limited)
Notes to the Restated Consolidated Financial Information

1. Basis of preparation (continued)

The Restated Consolidated Financial Information are presented in Indian Rupees "INR" or "Rs." and all values are stated as INR or Rs. millions, except when otherwise indicated.

These Restated Consolidated Financial Information were approved by the Board of Directors of the Company in their meeting held on 31 May 2021.

b. Principles of consolidation

The restated consolidated financial information includes the results of the following subsidiaries:

S. No.	Name of the Entity	Country of incorporation	Effective Group shareholding %
1	Fitwel Tools and Forgings Private Limited	India	70
2	Sansera Sweden AB	Sweden	100
3	Sansera Engineering Pvt. Ltd. Mauritius	Mauritius	100

c. Basis of consolidation

Business combinations (other than common control business combinations)

In accordance with Ind AS 103, the Group accounts for these business combinations using the acquisition method when control is transferred to the Group. The consideration transferred for the business combination is generally measured at fair value as at the date the control is acquired (acquisition date), as are the net identifiable assets acquired. Any goodwill that arises is tested annually for impairment. Any gain on a bargain purchase is recognised in Other Comprehensive Income ("OCI") and accumulated in equity as capital reserve if there exists clear evidence of the underlying reasons for classifying the business combination as resulting in a bargain purchase; otherwise the gain is recognised directly in equity as capital reserve. Transaction costs are expensed as incurred, except to the extent related to the issue of debt or equity securities.

Business combinations (common control business combinations)

In accordance with Appendix C to Ind AS 103 on Business combinations of entities under common control, the Group accounts for these business combinations using the pooling of interest method as per the guidance provided under Appendix C to Ind AS 103. The restated consolidated financial information in respect of prior periods are restated as if the combination had occurred from the beginning of the preceding period in the restated consolidated financial information, irrespective of the actual date of the combination. All the assets and liabilities including have been recorded at their existing carrying amounts.

Subsidiary companies

Subsidiary companies are all entities over which the Company has control. The Company controls an entity when the Group is exposed to, or has rights to, variable returns from its involvement with the entity and has the ability to affect those returns through its power to direct the relevant activities of the entity. Subsidiaries are fully consolidated from the date on which control is transferred to the Company. They are deconsolidated from the date that control ceases.

Sansera Engineering Limited (erstwhile Sansera Engineering Private Limited)
Notes to the Restated Consolidated Financial Information

2. Basis of preparation (continued)

Intercompany transactions, balances and unrealized gain / loss on transactions between Group companies are eliminated. The financial statements are prepared by applying uniform policies in use at the Group.

Non-Controlling Interests (NCI)

NCI in the results and equity of subsidiaries are shown separately in the restated consolidated statement of profit and loss, restated consolidated statement of changes in equity and restated consolidated statement of assets and liabilities respectively. NCI are measured at their proportionate share of the acquiree's net identifiable assets at the date of acquisition. The Company portion of equity in such subsidiary is determined on the basis of book values of assets and liabilities as per the financial statements of the concerned subsidiary as on the date of the investment.

d. Functional and presentation currency

Items included in the financial statements of each of the Group's entities are measured using the currency of the primary economic environment in which the entity operates ('the functional currency'). The consolidated financial statements are presented in Indian Rupees (INR), which is also the functional currency of the Company, and the presentation currency considered for the Group. The functional currency of the subsidiaries operations in Mauritius is Euro and that of its operations in Sweden is Swedish Krona (SEK).

For the purposes of presenting the restated consolidated statements of assets and liabilities of Group's foreign operations with functional currency different from the Company are translated into Company's functional currency i.e. INR using exchange rates prevailing at the end of each reporting period. Income and expense items are translated at the average exchange rates for the period, unless exchange rates fluctuate significantly during that period, in which case the exchange rates at the dates of the transactions are used.

Exchange differences arising, if any are recognised in other comprehensive income and accumulated in equity.

On the disposal of foreign operation, all of the exchange differences accumulated in equity in respect of that operation attributable to the owners of the Company are reclassified to the statement of profit and loss.

All amounts have been rounded-off to the nearest millions, unless otherwise indicated.

e. Basis of measurement

The restated consolidated financial information has been prepared on the historical cost basis except for the following items:

- Derivative instruments at fair value;
- Net defined benefit (asset)/liability at fair value of plan assets less present value of defined benefit obligations;
- Current investments at fair value through restated consolidated statement of profit and loss;
- Share based payments

Sansera Engineering Limited (erstwhile Sansera Engineering Private Limited)
Notes to the Restated Consolidated Financial Information

1. Basis of preparation (Continued)

f. Use of estimates and judgements

The preparation of the restated consolidated financial information in conformity with Ind AS requires management to make judgements, estimates and assumptions that affect the application of accounting policies and the reported amounts of assets, liabilities, income and expenses. Actual results may differ from these estimates. Estimates and underlying assumptions are reviewed on an ongoing basis. Revisions to accounting estimates are recognised in the period in which the estimates are revised and in any future periods affected.

Judgements

Information about judgements made in applying accounting policies that have the most significant effects on the amounts recognised in the restated consolidated financial information is included in lease classification.

Assumptions and estimation uncertainties

Information about assumptions and estimation uncertainties that have a significant risk of resulting in a material adjustment is included in the following notes:

- Note No.2(a), 2(b), 3(a) and 3(b) - Depreciation and amortisation method and useful life of items of property, plant and equipment and intangibles assets;
- Note 40 – Recognition of deferred tax assets;
- Note 21, 27 and 42 – Measurement of defined benefit obligations: key actuarial assumptions;
- Note 3(a) and 3(b) – Impairment of property, plant and equipment;
- Note 45 – Impairment of financial assets; and
- Note 51 – Impairment of goodwill.
- Note 15 and 26 – Derivative contracts at fair value

g. Measurement of fair values

Certain accounting policies and disclosures require the measurement of fair values, for both financial and non-financial assets and liabilities.

Fair values are categorized into different levels in a fair value hierarchy based on the inputs used in the valuation techniques as follows:

Level 1: quoted prices (unadjusted) in active markets for identical assets or liabilities.

Level 2: inputs other than quoted prices included in Level 1 that are observable for the asset or liability, either directly (i.e. as prices) or indirectly (i.e. derived from prices).

Level 3: inputs for the asset or liability that are not based on observable market data (unobservable inputs).

Sansera Engineering Limited (erstwhile Sansera Engineering Private Limited)
Notes to the Restated Consolidated Financial Information

1. Basis of preparation (Continued)

When measuring the fair value of an asset or a liability, the Group uses observable market data as far as possible. If the inputs used to measure the fair value of an asset or a liability fall into different levels of the fair value hierarchy, then the fair value measurement is categorized in its entirety in the same level of the fair value hierarchy as the lowest level input that is significant to the entire measurement. The Group recognizes transfers between levels of the fair value hierarchy at the end of the reporting period during which the change has occurred.

For the purpose of fair value disclosures, the Group has determined classes of assets and liabilities on the basis of the nature, characteristics and risks of the asset or liability and the level of the fair value hierarchy as explained above. This note summarises accounting policy for fair value. Other fair value related disclosures are given in the relevant notes.

- Note 43 – Employee stock options; and
- Note 44 of– Financial instruments;

2. Significant accounting policies

a. Property, plant and equipment

i. Recognition and measurement

Property, plant and equipment are measured at cost, less accumulated depreciation and accumulated impairment losses, if any.

Cost of an item of property, plant and equipment comprises its purchase price, including import duties and non-refundable purchase taxes, after deducting trade discounts and rebates, any directly attributable cost of bringing the item to its working condition for its intended use and estimated costs of dismantling and removing the item and restoring the site on which it is located.

All items of property, plant and equipment are stated at historical cost less depreciation. Historical cost includes expenditure that is directly attributable to the acquisition of the items. Subsequent costs are included in the asset's carrying amount or recognised as a separate asset, as appropriate, only when it is probable that future economic benefits associated with the item will flow to the Group and the cost of the item can be measured reliably. The carrying amount of any component accounted for as a separate asset is derecognised when replaced. All other repairs and maintenance are charged to profit or loss during the reporting period in which they are incurred.

If significant parts of an item of property, plant and equipment have different useful lives, then they are accounted for as separate items (major components) of property, plant and equipment.

Any gain or loss on disposal of an item of property, plant and equipment is recognised in the restated consolidated statement of profit or loss.

Borrowing costs directly attributable to the acquisition/construction of the qualifying asset are capitalized as part of the cost of that asset. Other borrowing costs are recognized as expense in the restated consolidated statement of profit and loss in the period in which they are incurred.

Sansera Engineering Limited (erstwhile Sansera Engineering Private Limited)
Notes to the Restated Consolidated Financial Information

2. Significant accounting policies (continued)

ii. Depreciation methods, estimated useful lives and residual values

Depreciation is provided on a Straight Line Method (“SLM”) over the useful life of property, plant and equipment as prescribed under Part C of Schedule II of the Companies Act, 2013. Depreciation for assets purchased/sold during a period is proportionately charged. The useful lives for property, plant and equipment is as follows:

Asset category	Estimated useful life (in years)
Buildings	30
Plant and machinery	15
Furniture and fixtures	10
Vehicles	8
Office equipment	5
Electrical installations	10
Computer (including software)	3-6

Freehold land is not depreciated.

b. Business combination, Goodwill and Intangible assets

Business combinations, other than through common control transactions, are accounted for using the purchase (acquisition) method in accordance with Ind AS 103, Business Combinations. The cost of an acquisition is measured as the fair value of the assets given, equity instruments issued and liabilities incurred or assumed at the date of exchange. The cost of acquisition also includes the fair value of any contingent consideration. Identifiable assets acquired and liabilities and contingent liabilities assumed in a business combination are measured initially at their fair value on the date of acquisition.

Business combinations through common control transactions are accounted on a pooling of interests method. Transaction costs incurred in connection with a business combination are expensed as incurred.

(i) Goodwill:

The excess of the cost of acquisition over the Group’s share in the fair value of the acquiree’s identifiable assets, liabilities and contingent liabilities is recognized as goodwill. Any goodwill that arises is tested annually for impairment.

(ii) Customer relationships:

Ind AS 103 requires the identifiable intangible assets and contingent consideration to be fair valued in order to ascertain the net fair value of identifiable assets, liabilities and contingent liabilities of the acquiree. Significant estimates are required to be made in determining the value of contingent consideration and intangible assets. These valuations are conducted by independent valuation experts. Such intangible assets are subsequently measured at cost less accumulated amortisation and accumulated impairment losses. The estimated useful life for customer relationship is expected to be 7 years. The residual values, useful lives and method of amortisation of intangible assets are reviewed at each financial year end and adjusted if appropriate.

Sansera Engineering Limited (erstwhile Sansera Engineering Private Limited)
Notes to the Restated Consolidated Financial Information

2. Significant accounting policies (continued)

c. Inventories

- i. Inventories are measured at the lower of cost and net realisable value (NRV). Cost comprises purchase price and all expenses incurred in bringing the inventory to its present location and condition. Cost has been determined as follows:

Raw material, stores and spares	:	on weighted average basis
Work in progress	:	includes cost of conversion
Finished goods	:	includes cost of conversion

- ii. Fixed production overheads are allocated on the basis of normal capacity of production facilities. The comparison of cost and NRV is made on an item-by-item basis. Spare parts that meets the definition of asset are capitalised at their respective carrying amounts. The NRV of work-in-progress is determined with reference to NRV of related finished goods.
- iii. Raw materials and other supplies held for use in production of inventories are not written down below cost except in cases where material prices have declined, and it is estimated that the cost of the finished products will exceed their NRV.
- iv. Provision for inventory obsolescence is assessed periodically and is provided as considered necessary.

d. Revenue recognition

The Group recognises revenue to depict the transfer of control of promised goods or services to customers in an amount that reflects the consideration to which the Group expects to receive in exchange for those goods or services. A 5-step approach is used to recognise revenue as below:

- Step 1: Identify the contract(s) with a customer;
Step 2: Identify the performance obligation in contract;
Step 3: Determine the transaction price;
Step 4: Allocate the transaction price to the performance obligations in the contract; and
Step 5: Recognise revenue when (or as) the entity satisfies a performance obligation.

Revenue is recognised upon transfer of control of goods or services to buyer in an amount that reflects the consideration which the Group expects to receive in exchange for those goods or services.

Sale of products is adjusted net of Goods and Service tax, returns, trade discounts, and volume rebates. Service income is recognized when the related services are rendered unless significant future contingencies exist.

Export incentives are recognised in the restated consolidated statement of profit and loss when the right to receive credit as per the terms of the entitlement is established in respect of the export made.

Sansera Engineering Limited (erstwhile Sansera Engineering Private Limited)
Notes to the Restated Consolidated Financial Information

2. Significant accounting policies (continued)

Dividend income is recognised in restated consolidated statement of profit and loss on the date on which the right to receive the payment is established. Interest on the deployment of funds is recognised using the time-proportion method, based on underlying interest rates.

e. Foreign currency transactions and balances

Foreign currency transactions are translated into the functional currency using the exchange rates at the dates of the transactions. Foreign exchange gains and losses resulting from the settlement of such transactions and from the translation of monetary assets and liabilities denominated in foreign currencies at year end exchange rates are generally recognised in the restated consolidated statement of profit and loss.

Foreign exchange differences regarded as an adjustment to borrowing costs are presented in the restated consolidated statement of profit and loss, within finance costs. All other foreign exchange gains and losses are presented in the restated consolidated statement of profit and loss on a net basis within other gains/ (losses). Non-monetary items that are measured at fair value in a foreign currency are translated using the exchange rates at the date when the fair value was determined. Translation differences on assets and liabilities carried at fair value are reported as part of the fair value gain or loss.

Goodwill and fair value adjustments arising on the acquisition of a foreign entity are treated as assets and liabilities of the foreign entity and translated at the exchange rate in effect at the balance sheet date.

Foreign currency gains and losses are reported on a net basis. This includes changes in the fair value of foreign exchange derivative instruments, which are accounted at fair value through profit or loss

f. Government grants

Government grants are recognised at their fair value where there is reasonable assurance that the grant will be received and the Group will comply with all attached conditions.

Grants related to assets are government grants whose primary condition is that an entity qualifying for them should purchase, construct or otherwise acquire long-term assets. Grants related to income are government grants other than those related to assets.

Government grants relating to an expense item are recognized in the restated consolidated statement of profit and loss over the period necessary to match them with the costs that they are intended to compensate and presented as a deduction in reporting the related expense. The presentation approach is applied consistently to all similar grants.

Government grants relating to the purchase of property, plant and equipment are included in liabilities as deferred income and are credited to the restated consolidated statement of profit and loss over the periods and in proportions in which depreciation expense on those assets is recognized.

Sansera Engineering Limited (erstwhile Sansera Engineering Private Limited)
Notes to the Restated Consolidated Financial Information

2. Significant accounting policies (continued)

Income from export incentives are recognized in the restated consolidated statement of profit and loss when the right to receive credit as per the terms of the entitlement is established in respect of exports made and disclosed as other operating revenues.

Income from government incentives (other than export incentive) are recognized in the restated consolidated statement of profit and loss when the right to receive credit as per the terms of the entitlement and disclosed as a reduction to the related expenses.

g. Leases

A contract is, or contains, a lease if the contract conveys the right to control the use of an identified asset for a period of time in exchange for consideration.

Group as a lessee

The Group accounts for each lease component within the contract as a lease separately from non-lease components of the contract and allocates the consideration in the contract to each lease component on the basis of the relative stand-alone price of the lease component and the aggregate stand-alone price of the non-lease components.

The Group recognises a right-of-use asset representing its right to use the underlying asset for the lease term at the lease commencement date and a lease liability at the lease commencement date. The cost of the right-of-use asset measured at inception shall comprise the amount of the initial measurement of the lease liability adjusted for any lease payments made at or before the commencement date less any lease incentives received, plus any initial direct costs incurred and an estimate of costs to be incurred by the lessee in dismantling and removing the underlying asset or restoring the underlying asset or site on which it is located. The right-of-use assets is subsequently measured at cost less any accumulated depreciation, accumulated impairment losses, if any and adjusted for any remeasurement of the lease liability. The right-of-use assets is depreciated using the straight-line method from the commencement date over the shorter of lease term or useful life of right-of-use asset. The estimated useful lives of right-of-use assets are determined on the same basis as those of property, plant and equipment. Right-of-use assets are tested for impairment whenever there is any indication that their carrying amounts may not be recoverable. Impairment loss, if any, is recognised in the restated consolidated statement of profit and loss.

The Group measures the lease liability at the present value of the lease payments that are not paid at the commencement date of the lease. The lease payments are discounted using the interest rate implicit in the lease, if that rate can be readily determined. If that rate cannot be readily determined, the Group uses incremental borrowing rate. For leases with reasonably similar characteristics, the Group, on a lease by lease basis, may adopt either the incremental borrowing rate specific to the lease or the incremental borrowing rate for the portfolio as a whole. The lease payments shall include fixed payments, variable lease payments, residual value guarantees, exercise price of a purchase option where the Group is reasonably certain to exercise that option and payments of penalties for terminating the lease, if the lease term reflects the lessee exercising an option to terminate the lease. The lease liability is subsequently remeasured by increasing the carrying amount to reflect interest on the lease liability, reducing the carrying amount to reflect the lease payments made and remeasuring the carrying amount to reflect any reassessment or lease modifications or to reflect revised in-substance fixed lease payments. The Group recognises the amount of the re-measurement of lease liability due to modification as an adjustment to the right-of-use asset and a charge or credit to the restated consolidated statement of profit and loss depending upon the nature of modification. Where the carrying amount of the right-of-use asset is reduced to zero and there is a further reduction in the measurement of the lease liability, the Group recognises any remaining amount of the re-measurement in restated consolidated statement of profit and loss.

Sansera Engineering Limited (erstwhile Sansera Engineering Private Limited)
Notes to the Restated Consolidated Financial Information

2. Significant accounting policies (continued)

Lease payments associated with following leases are recognised as expense on straight-line basis:

- (i) Low value leases; and
- (ii) Leases which are short-term

h. Financial instruments

i. Recognition and initial measurement

Trade receivables are initially recognised when they are originated. All other financial assets and liabilities are recognised when the Group becomes a party to the contractual provisions of the instrument. Financial assets and liabilities are initially measured at fair value. Transaction costs that are directly attributable to the acquisition or issue of financial assets and financial liabilities (other than financial assets and financial liabilities at fair value through profit or loss) are added to or deducted from the fair value measured on initial recognition of financial asset or financial liability.

A financial asset or financial liability is initially measured at fair value plus, for an item not at fair value through profit and loss (FVTPL), transaction costs that are directly attributable to its acquisition or issue.

ii. Classification and subsequent measurement

Financial assets

Cash and cash equivalents

Cash and cash equivalents includes cash on hand, other short-term highly liquid investments with original maturities of three months or less that are readily convertible to known amounts of cash and which are subject to an insignificant risk of changes in value.

Financial assets carried at amortised cost.

A financial asset is subsequently measured at amortised cost if it is held within a business model whose objective is to hold the asset in order to collect contractual cash flows and the contractual terms of the financial asset give rise on specified dates to cash flows that are solely payments of principal and interest on the principal amount outstanding.

Financial assets at fair value through other comprehensive income

A financial asset is subsequently measured at fair value through other comprehensive income (FVOCI) if it is held within a business model whose objective is achieved by both collecting contractual cash flows and selling financial assets and the contractual terms of the financial asset give rise on specified dates to cash flows that are solely payments of principal and interest on the principal amount outstanding.

Sansera Engineering Limited (erstwhile Sansera Engineering Private Limited)
Notes to the Restated Consolidated Financial Information

2. Significant accounting policies (continued)

Financial assets at fair value through profit or loss

A financial asset that is not classified in any of the above categories is subsequently fair valued through profit or loss (FVTPL). This include all derivative assets and current investments.

Financial liabilities

Financial liabilities at FVTPL are measured at fair value and net gains and losses, including any interest expense and are recognised in the restated consolidated statement of profit and loss. Other financial liabilities are subsequently carried at amortised cost using the effective interest method. Interest expense and foreign exchange gains and losses are recognised in profit or loss. Any gain or loss on derecognition is also recognised in profit or loss.

Derivative Instruments

The Group holds derivative financial instruments, such as foreign exchange forward contracts to mitigate the risk of changes in exchange rates on foreign currency exposures. The counterparty, for these contracts is generally a bank. These derivative instruments are recorded at fair value on every reporting date with changes being accounted in the restated consolidated statement of profit and loss.

iii. Derecognition

Financial assets

The Group derecognises a financial asset when the contractual rights to the cash flows from the financial asset expire, or it transfers the rights to receive the contractual cash flows in a transaction in which substantially all of the risks and rewards of ownership of the financial asset are transferred or in which the Group neither transfers nor retains substantially all of the risks and rewards of ownership and does not retain control of the financial asset.

Financial liabilities

The Group derecognises a financial liability when its contractual obligations are discharged or cancelled, or expire.

The Group also derecognises a financial liability when its terms are modified and the cash flows under the modified terms are substantially different. In this case, a new financial liability based on the modified terms is recognised at fair value. The difference between the carrying amount of the financial liability extinguished and the new financial liability with modified terms is recognised in the restated consolidated statement profit or loss.

Sansera Engineering Limited (erstwhile Sansera Engineering Private Limited)
Notes to the Restated Consolidated Financial Information

2. Significant accounting policies (continued)

i. Impairment

i. Impairment of financial instruments

The Group recognises loss allowances for expected credit losses (ECL) on financial assets measured at amortised cost.

At each reporting date, the Group assesses whether financial assets carried at amortised cost are credit impaired. A financial asset is 'credit-impaired' when one or more events that have a detrimental impact on the estimated future cash flows of the financial assets have occurred.

The Group follows 'simplified approach' for recognition of impairment loss allowance on trade receivables. The application of simplified approach does not require the Group to track changes in credit risk. Rather, it recognizes impairment loss allowance based on lifetime ECLs at each reporting date, right from its initial recognition. For recognition of impairment loss on other financial assets and risk exposure, the Group determines whether there has been a significant increase in the credit risk since initial recognition. If credit risk has not increased significantly, 12-month ECL is used to provide for impairment loss. However, if credit risk has increased significantly, lifetime ECL is used. If in subsequent period, credit quality of the instrument improves such that there is no longer a significant increase in credit risk since initial recognition, then the Group reverts to recognizing impairment loss allowance based on 12 month ECL.

ii. Impairment of non - financial assets

The Group's non-financial assets, other than inventories and deferred tax assets, are evaluated for recoverability whenever events or changes in circumstances indicate that their carrying amounts may not be recoverable. For the purpose of impairment testing, the recoverable amount (i.e. the higher of the fair value less cost to sell and the value-in-use) is determined on an individual asset basis unless the asset does not generate cash flows that are largely independent of those from other assets. In such cases, the recoverable amount is determined for the Cash Generating Unit (CGU) to which the asset belongs.

If such assets are considered to be impaired, the impairment to be recognised in the restated consolidated statement of profit and loss is measured by the amount by which the carrying value of the assets exceeds the estimated recoverable amount of the asset.

An impairment loss in respect of goodwill is not subsequently reversed. In respect of assets for which impairment loss has been recognised in prior periods, the Group reviews at each reporting date whether there is any indication that the loss has decreased or no longer exists. An impairment loss is reversed in the restated consolidated statement of profit and loss if there has been a change in the estimates used to determine the recoverable amount.

The carrying amount of the asset is increased to its revised recoverable amount, provided that this amount does not exceed the carrying amount that would have been determined (net of any accumulated amortisation or depreciation) had no impairment loss been recognised for the asset in prior years.

Sansera Engineering Limited (erstwhile Sansera Engineering Private Limited)
Notes to the Restated Consolidated Financial Information

2. Significant accounting policies (continued)

j. Employee benefits

i. Defined benefit plan

Gratuity

The Group's gratuity plan is a defined benefit plan. The present value of obligation under such defined benefit plan is determined based on actuarial valuation carried out by an independent actuary using the projected unit credit method. The obligation is measured at the present value of estimated future cash flows. The discount rates used for determining the present value of obligation under defined benefit plan is based on the market yields on Government securities as at the reporting date, having maturity periods approximating to the terms of related obligations. Actuarial gains and losses are recognised immediately in the Restated consolidated statement of assets and liabilities with a corresponding debit or credit to retained earnings through OCI in the period in which they occur.

Compensated absences

The employees of the Group are entitled to compensated absences. The employees can carry forward a portion of the unutilised accumulating compensated absence and utilise it in future periods or receive cash compensation at retirement or termination of employment. The Group records an obligation for compensated absences in the period in which the employee renders the services that increases this entitlement. The Group measures the expected cost of compensated absence as the additional amount that the Group expects to pay as a result of the unused entitlement that has accumulated at the reporting date. The calculation of the Group's obligation is performed annually by an independent actuary using the projected unit credit method as at the reporting date.

Non-accumulating compensated absences are recognised in the period in which the absences occur. The Group recognizes actuarial gains and losses immediately in the restated consolidated statement of profit and loss.

ii. Defined contribution plan

Provident fund

Provident fund is a post-employment benefit plan under which the Group makes specified monthly contribution towards Government administered provident fund scheme. Obligations for contributions to defined contribution plan are recognised as an employee benefit expense in the restated consolidated statement of profit and loss during the period in which the related services are rendered by the employees.

Sansera Engineering Limited (erstwhile Sansera Engineering Private Limited)
Notes to the Restated Consolidated Financial Information

2. Significant accounting policies (continued)

iii. Share-based payment transactions

Employees of the Group receive remuneration in the form of equity settled instruments, for rendering services over a defined vesting period. Equity instruments granted are measured by reference to the fair value of the instrument at the date of grant. The expense is recognised in the restated consolidated statement of profit and loss with a corresponding increase in equity over the period that the employees unconditionally becomes entitled to the award. The equity instruments generally vest in a graded manner over the vesting period.

The fair value determined at the grant date is expensed over the vesting period of the respective tranches of such grants. The stock compensation expense is determined based on the Group's estimate of equity instruments that will eventually vest.

k. Taxes

Current income tax

Current income tax comprises the expected tax payable or receivable on the taxable income or loss for the year and any adjustment to the tax payable or receivable in respect of previous years. The amount of current income tax reflects the best estimate of the tax amount expected to be paid or received after considering the uncertainty, if any, related to income taxes. It is measured using tax rates (and tax laws) enacted or substantively enacted at the reporting date.

Current income tax relating to items recognised outside profit or loss is recognised outside profit or loss (either in other comprehensive income or in equity). Current tax items are recognised in correlation to the underlying transaction either in OCI or directly in equity. Management periodically evaluates positions taken in the tax returns with respect to situations in which applicable tax regulations are subject to interpretation and establishes provisions where appropriate.

Deferred income tax

Deferred tax is recognised in respect of temporary differences between the carrying amounts of assets and liabilities for financial reporting purposes and the amounts used for taxation purposes. Deferred tax is not recognised for temporary differences on the initial recognition of assets or liabilities in a transaction that is not a business combination and that affects neither accounting nor taxable profit or loss.

Deferred tax is measured at the tax rates that are expected to be applied to the temporary differences when they reverse, based on the laws that have been enacted or substantively enacted at the reporting date.

Deferred tax assets and liabilities are offset if there is a legally enforceable right to offset current tax liabilities and assets and they relate to taxes levied by the same tax authority on the same taxable entity.

A deferred tax asset is recognised for unused tax losses, tax credits and deductible temporary differences, to the extent that it is probable that future taxable profits will be available against which they can be utilised. Deferred tax assets are reviewed at each reporting date and are reduced to the extent that it is no longer probable that the related tax benefit will be realised.

Sansera Engineering Limited (erstwhile Sansera Engineering Private Limited)
Notes to the Restated Consolidated Financial Information

2. Significant accounting policies (continued)

Minimum alternate tax

Minimum alternate tax ('MAT') credit is recognised as an asset only when and to the extent there is convincing evidence that the Group will pay normal income-tax during the specified period. In the year in which the MAT credit becomes eligible to be recognised as an asset, the said asset is created by way of a credit to the restated consolidated statement of profit and loss. The Group reviews the same at each reporting date and writes down the carrying amount of MAT credit entitlement, if any, to the extent there is no longer convincing evidence to the effect that the Group will pay normal income-tax during the specified period.

l. Earnings per share

The basic earnings per share is calculated by dividing the net profit for the year attributable to the owners of the Company by the weighted average number of equity shares outstanding during the year.

Diluted earnings per share is calculated by dividing the profit for the year attributable to the owners of the Company by the weighted average number of equity shares outstanding during the year, after adjustment for the effects of all dilutive potential equity shares.

m. Provisions and contingencies

A provision is recognised when an enterprise has a present obligation as a result of past events, it is probable that an outflow of resources will be required to settle the obligation and the amount can be reliably estimated. Provisions are determined by discounting the expected future cash flows to their present value and are determined based on best estimate required to settle the obligation at the reporting date. These are reviewed at each reporting date and adjusted to reflect the current best estimates. Provisions for onerous contracts, i.e. contracts where the expected unavoidable costs of meeting the obligations under the contract exceed the economic benefits expected to be received under it, are recognised when it is probable that an outflow of resources embodying economic benefits will be required to settle a present obligation as a result of an obligating event, based on a best estimate of such obligation.

Contingent liabilities are disclosed when there is a possible obligation arising from past events, the existence of which will be confirmed only by the occurrence or non-occurrence of one or more uncertain future events not wholly within the control of the Group or a present obligation that arises from past events where it is either not probable that an outflow of resources will be required to settle the obligation or a reliable estimate of the amount cannot be made. Contingent assets are neither recognised nor disclosed in the restated consolidated financial information.

n. Restated consolidated cash flow statement

Cash flows are reported using the indirect method, whereby net profit/(loss) before tax is adjusted for the effects of transactions of a non-cash nature, any deferrals or accruals of past or future operating cash receipts or payments and item of income or expenses associated with investing or financing cash flows. The cash flows from operating, investing and financing activities of the Group are segregated.

Sansera Engineering Limited (erstwhile Sansera Engineering Private Limited)
Notes to the Restated Consolidated Financial Information

2. Significant accounting policies (continued)

o. Segment reporting

Based on the "management approach" as defined in Ind AS 108 - Operating Segments, Managing Director of the Group has been identified as the Chief Operating Decision Maker (CODM). The CODM evaluates the Group's performance and allocates resources based on single segment approach and accordingly information has been presented.

p. Recent accounting pronouncements

On March 24, 2021, the Ministry of Corporate Affairs (MCA) through a notification, amended Schedule III of the Companies Act, 2013. The amendments revise Division I, II and III of Schedule III and are applicable from April 1, 2021. The Group is evaluating the effect of the amendments on its financial statements.

3 (a) Property, plant and equipment

(Amount in ₹ millions)

Particulars	Owned property, plant and equipment									Leasehold land (Refer note 3) ##	Total
	Land # (1)	Buildings (2)	Plant and machinery (3)	Furniture and fixtures (4)	Vehicles (5)	Office equipment (6)	Electrical installations (7)	Computers (8)	Leasehold improvements (9)		
Gross carrying amount											
Balance as at 1 April 2018	336.68	728.55	5,982.28	43.27	102.42	33.28	264.07	68.29	-	39.91	7,598.75
Additions	5.97	273.22	2,368.89	4.37	29.29	11.70	167.36	18.34	202.01	-	3,081.15
Disposals	-	-	(6.47)	-	(0.46)	(4.19)	(0.62)	-	-	-	(11.74)
Effect of foreign exchange differences	-	-	4.73	-	-	-	-	-	-	-	4.73
Reclassified on account of adoption of Ind AS 116	-	-	-	-	-	-	-	-	-	(37.90)	(37.90)
Balance as at 31 March 2019	342.65	1,001.77	8,349.43	47.64	131.25	40.79	430.81	86.63	202.01	2.01	10,634.99
Additions	-	210.65	1,094.85	2.93	5.81	3.30	64.34	24.99	1.31	-	1,408.18
Disposals	-	-	(42.73)	-	(11.63)	(0.10)	(1.05)	-	-	-	(55.51)
Effect of foreign exchange differences	-	-	4.73	-	-	-	-	-	-	-	4.73
Balance as at 31 March 2020	342.65	1,212.42	9,406.28	50.57	125.43	43.99	494.10	111.62	203.32	2.01	11,992.39
Reclass from intangible asset	-	-	-	-	-	-	-	0.70	-	-	0.70
Additions	123.61	30.93	1,269.00	0.80	4.63	8.03	33.04	9.44	4.81	-	1,484.29
Disposals	-	-	(18.81)	-	(3.36)	(0.10)	-	(17.60)	-	-	(39.87)
Effect of foreign exchange differences	-	-	28.35	0.17	-	1.02	-	1.87	19.30	-	50.71
Balance as at 31 March 2021	466.26	1,243.35	10,684.82	51.54	126.70	52.94	527.14	106.03	227.43	2.01	13,488.22
Accumulated depreciation											
Balance as 1 April 2018	-	55.32	834.85	12.36	25.90	11.97	85.64	30.29	-	0.88	1,057.21
Charge for the year	-	34.30	570.90	8.57	17.54	7.02	38.51	15.98	4.65	-	697.47
Disposals	-	-	(3.63)	-	(0.32)	(3.88)	(0.62)	-	-	-	(8.45)
Effect of foreign exchange differences	-	-	(1.07)	-	-	-	-	-	-	-	(1.07)
Reclassified on account of adoption of Ind AS 116	-	-	-	-	-	-	-	-	-	(0.88)	(0.88)
Balance as at 31 March 2019	-	89.62	1,401.05	20.93	43.12	15.11	123.53	46.27	4.65	-	1,744.28
Charge for the year	-	41.95	711.59	4.21	17.49	7.82	45.16	17.23	11.65	-	857.10
Disposals	-	-	(17.11)	-	(11.15)	(0.01)	(0.96)	-	-	-	(29.23)
Effect of foreign exchange differences	-	-	(1.07)	-	-	-	-	-	-	-	(1.07)
Balance as at 31 March 2020	-	131.57	2,094.46	25.14	49.46	22.92	167.73	63.50	16.30	-	2,571.08
Reclass from intangible asset	-	-	-	-	-	-	-	(1.20)	-	-	(1.20)
Charge for the year	-	45.79	768.04	6.09	17.74	5.57	47.11	15.55	24.47	-	930.36
Disposals	-	-	(12.14)	-	(3.36)	(0.02)	-	(17.60)	-	-	(33.12)
Effect of foreign exchange differences	-	-	18.60	0.22	-	0.26	-	0.09	1.88	-	21.05
Balance as at 31 March 2021	-	177.36	2,868.96	31.45	63.84	28.73	214.84	60.34	42.65	-	3,488.17
Carrying amounts (net)											
Balance as at 31 March 2021	466.26	1,065.99	7,815.86	20.09	62.86	24.21	312.30	45.69	184.78	2.01	10,000.05
Balance as at 31 March 2020	342.65	1,080.85	7,311.82	25.43	75.97	21.07	326.37	48.12	187.02	2.01	9,421.31
Balance as at 31 March 2019	342.65	912.15	6,948.38	26.71	88.13	25.68	307.28	40.36	197.36	2.01	8,890.71

Note:

- # It includes land measuring 57,922.41 sq.mts allocated by Karnataka Industrial Area Development (KIADB) at Plot no. 48, 2nd Phase, Sector -2, Bidadi Industrial Area for a period of 10 years w.e.f 8th Aug 2014 and 870.75 sq.mts allocated by Karnataka Small State Industrial Development Corporation (KSSIDC) at Industrial Estate, Antharasanahalli, Tumkur for a period of 6 years w.e.f. 29th Sep 2012, to the Group on a lease cum sale basis.
- ## Karnataka Small State Industrial Development Corporation (KSSIDC) has allotted land admeasuring 4,257 sq. mt. at Unit No. 5, KHT Complex, Antarasanahalli, Tumkur, Karnataka on a lease cum sale basis for a period of 4 years w.e.f. 8 January 1987, with specified terms and conditions to be complied with by each party. Subsequently, KSSIDC failed to comply with the terms of the agreement, hence the Group retained possession of the land. Pursuant to the communications with the KSSIDC, the Group has paid an amount of ₹ 2.01 million as consideration for the land, which has been capitalised. As at the balance sheet date, negotiations are in progress and the Group awaits the final approval of KSSIDC with respect to the registration of the land in the name of the Group.

- i Refer note 57 for details of charge over the Group's property, plant and equipment for the borrowings taken by the Group.
- ii Refer note 23 for amortisation of Government grant related to property, plant and equipment.

Sansera Engineering Limited (formerly known as Sansera Engineering Private Limited)
Notes to the Restated Consolidated Financial Information (continued)

3 (b) Intangible Assets	(Amount in ₹ millions)		
Particulars	Owned intangible asset		Total
	Customer relationship	Computer Software	
Gross carrying amount			
Balance as at 1 April 2018	32.49	15.38	47.87
Additions	-	-	-
Disposals	-	-	-
Balance as at 31 March 2019	32.49	15.38	47.87
Additions	-	-	-
Disposals	-	-	-
Balance as at 31 March 2020	32.49	15.38	47.87
Reclass to computers		(0.70)	(0.70)
Additions	-	-	-
Disposals	-	-	-
Effect of foreign exchange differences	5.13	-	5.13
Balance as at 31 March 2021	37.62	14.68	52.30
Accumulated amortisation			
Balance as at 1 April 2018	4.64	3.87	8.51
Amortisation for the year	4.64	2.18	6.82
Disposals	-	-	-
Balance as at 31 March 2019	9.28	6.05	15.33
Amortisation for the year	4.64	2.18	6.82
Disposals	-	-	-
Balance as at 31 March 2020	13.92	8.23	22.15
Reclass to computers	-	1.20	1.20
Amortisation for the year	4.64	2.20	6.84
Disposals	-	-	-
Effect of foreign exchange differences	2.94	-	2.94
Balance as at 31 March 2021	21.50	11.63	33.13
Carrying amounts (net)			
Balance as at 31 March 2021	16.12	3.05	19.17
Balance as at 31 March 2020	18.57	7.15	25.72
Balance as at 31 March 2019	23.21	9.33	32.54

3 (c) Right-of-use assets and lease liabilities

i) Following are the changes in the carrying value of right of use assets for the year ended 31 March 2021:

Particulars	Leased asset		Total
	Land	Buildings	
Balance as at 1 April 2018	0.08	136.28	136.36
On account of adoption of Ind AS 116	37.02	9.43	46.45
Additions	-	767.01	767.01
Deletion	-	-	-
Depreciation	(0.45)	(52.80)	(53.25)
Balance as at 31 March 2019	36.65	859.92	896.57
Additions	-	51.48	51.48
Deletion	-	-	-
Depreciation	(0.44)	(74.64)	(75.08)
Balance as at 31 March 2020	36.21	836.76	872.97
Additions	-	15.31	15.31
Deletion	-	-	-
Depreciation	(0.46)	(79.10)	(79.56)
Effect of foreign exchange differences	-	83.63	83.63
Balance as at 31 March 2021	35.75	856.60	892.35

ii) The following is the movement in lease liabilities during the year ended 31 March 2021:

Particulars	Leased Liability		Total
	Land	Buildings	
Balance as at 1 April 2018	1.72	159.73	161.45
Additions	-	767.00	767.00
Finance cost accrued during the year	0.14	30.93	31.07
Deletions	-	-	-
Payments	(0.14)	(67.19)	(67.33)
Balance as at 31 March 2019	1.72	890.47	892.19
Additions	-	48.65	48.65
Finance cost accrued during the year	0.14	39.42	39.56
Deletions	-	-	-
Payments	(0.14)	(96.17)	(96.31)
Effect of foreign exchange differences	-	1.44	1.44
Balance as at 31 March 2020	1.72	883.81	885.53
Additions	-	15.31	15.31
Finance cost accrued during the year	0.14	41.66	41.80
Rental concession*	-	(2.71)	(2.71)
Deletions	-	-	-
Payments	(0.14)	(102.41)	(102.55)
Effect of foreign exchange differences	-	83.78	83.78
Balance as at 31 March 2021	1.72	919.44	921.16

iii) The following is the break-up of current and non-current lease liabilities:

Particulars	As at	As at	As at
	31 March 2021	31 March 2020	31 March 2019
Current lease liabilities	110.88	96.94	86.48
Non-current lease liabilities	810.28	788.59	805.71
Total	921.16	885.53	892.19

Sansera Engineering Limited (formerly known as Sansera Engineering Private Limited)
Notes to the Restated Consolidated Financial Information (continued)

(Amount in ₹ millions)

iv) The table below provides details regarding the contractual maturities of lease liabilities on an undiscounted basis:

Particulars	As at	As at	As at
	31 March 2021	31 March 2020	31 March 2019
Less than one year	110.88	96.94	86.48
One to five years	369.25	368.30	335.71
More than five years	701.54	687.76	763.70
Total lease liabilities	1,181.67	1,153.00	1,185.89
Less: implicit interest	(260.51)	(267.47)	(293.70)
Lease liabilities included in Balance sheet	921.16	885.53	892.19

v) Amount recognised in statement of profit and loss

Particulars	For the year ended	For the year ended	For the year ended
	31 March 2021	31 March 2020	31 March 2019
Depreciation on right-of-use assets	79.56	75.08	53.25
Interest on lease liabilities	41.80	39.56	31.07
Low value lease rentals and short term lease (included with rent, classified under other expenses)	3.08	4.84	6.60

vi) Amount recognised in statement of cash flow

Particulars	As at	As at	As at
	31 March 2021	31 March 2020	31 March 2019
Cash outflows for leases			
Interest portion of lease liabilities	41.80	39.56	31.07
Principal portion of lease liabilities	60.75	56.75	36.26
	102.55	96.31	67.33

*During the year the Group has applied the practical expedient to all eligible rent concessions and subsequently an amount of ₹2.71 million has been recognized in profit or loss.

4 Goodwill			
Particulars	As at 31 March 2021	As at 31 March 2020	As at 31 March 2019
Carrying amount at the beginning of the year	323.64	324.21	342.96
Exchange differences on translation of foreign operations	34.73	(0.57)	(18.75)
Total	358.37	323.64	324.21
Note: For details of impairment tests for goodwill refer note 51.			
5 Non-current investments			
Particulars	As at 31 March 2021	As at 31 March 2020	As at 31 March 2019
Unquoted			
Other Investment-Unquoted (Measured at fair value through other comprehensive income)			
Cleanmax Vega Power LLP*	36.93	36.93	-
26% (31 March 2020: 26%; 31 March 2019: Nil)			
Total	36.93	36.93	-
* On May 3, 2019, the Group had entered in to a Group Captive Power Project agreement with Clean Max Vega Power LLP (“LLP”) and Clean Max Enviro Energy Solutions Private Limited towards generation and supply of renewable energy for private consumers of electricity. The agreement is for the period of 25 years wherein the Group has committed to purchase at least 51% of the total power produced by the power producer.			
Aggregate amount of unquoted investments	36.93	36.93	-
Aggregate amount of quoted investments	-	-	-
Aggregate amount of impairment in investments	-	-	-
6 Non-current loans			
Particulars	As at 31 March 2021	As at 31 March 2020	As at 31 March 2019
Security deposits			
-Unsecured, considered good	284.54	267.10	257.32
-Doubtful	-	-	-
Total	284.54	267.10	257.32
7 Other financial assets			
Particulars	As at 31 March 2021	As at 31 March 2020	As at 31 March 2019
Bank deposits (due to mature after 12 months from the reporting date)*	4.94	8.36	5.85
Loan to key managerial personnel (refer note 41)	-	3.88	2.88
Loan to employees	9.15	22.57	25.51
Total	14.09	34.81	34.24
* Includes certain deposits pledged against bank guarantees and letter of credits provided by the bank.			
8 (a) Tax assets for current taxes (net)			
Particulars	As at 31 March 2021	As at 31 March 2020	As at 31 March 2019
Advance tax including tax deducted at source, net of provision for tax	27.14	29.30	62.48
Total	27.14	29.30	62.48
8 (b) Income tax liabilities (net)			
Particulars	As at 31 March 2021	As at 31 March 2020	As at 31 March 2019
Provision for tax, net of advance tax including tax deducted at source	0.59	29.52	82.51
Total	0.59	29.52	82.51
9 Other non current assets			
Particulars	As at 31 March 2021	As at 31 March 2020	As at 31 March 2019
Capital advances	220.38	197.48	220.74
Prepayments	0.49	3.07	-
Duty paid under protest	3.83	4.13	6.29
Total	224.70	204.68	227.03

10 Inventories (valued at lower of cost and net realisable value)

Particulars	As at	As at	As at
	31 March 2021	31 March 2020	31 March 2019
Raw materials *	838.03	722.90	772.26
Work in progress	915.74	891.06	907.07
Finished goods **	395.15	369.27	322.87
Stores and spares	355.06	417.39	432.39
Total	2,503.98	2,400.62	2,434.59
Less: Provision for obsolete inventory	18.29	11.44	-
Total	2,485.69	2,389.18	2,434.59

* Includes stock of assembled components.

** Includes stock in transit of ₹ 83.87 million (31 March 2020 : ₹ 57.42 million ; 31 March 2019 : ₹ 29.37 million)

The mode of valuation of inventories has been stated in note 2.c

11 Current investments

Particulars	As at	As at	As at
	31 March 2021	31 March 2020	31 March 2019
Quoted equity shares, trade			
Equity shares at fair value through statement of profit and loss			
800 (31 March 2020: 800; 31 March 2019: 800) equity shares of ₹10 each fully paid up of Maruti Suzuki India Ltd	5.58	3.53	5.34
Total	5.58	3.53	5.34
Aggregate amount of quoted investments	5.58	3.53	5.34
Aggregate amount of unquoted investments	-	-	-
Aggregate amount of impairment in investments	-	-	-

12 Trade receivables

Particulars	As at	As at	As at
	31 March 2021	31 March 2020	31 March 2019
Considered good - Secured.	-	-	-
Considered good - Unsecured	3,153.44	2,591.21	2,712.43
That have an increase in Credit Risk that is significant.	-	23.61	23.61
Credit impaired	-	-	-
	3,153.44	2,614.82	2,736.04
Less: Allowance for credit losses	(23.61)	(23.61)	(23.61)
Total	3,129.83	2,591.21	2,712.43

The average credit period on sales of goods for the year ended 31 March 2021 is 59 - 72 days. No interest is charged on trade receivables.

The Group has used a practical expedient by computing the expected credit loss allowance for trade receivables based on a provision matrix. The provision matrix takes into account historical credit loss experience and adjusted for forward-looking information. The expected credit loss allowance is based on the ageing of the days the receivables are due and the rebates as given in the provision matrix. The provision matrix at the end of the reporting period is as follows

Ageing	Expected Credit loss (%)
within the credit period	0.00%
1-90 days past due	0.05% to 0.84%
91-180 days past due	1.88% to 2.00%
181-270 days past due	9.81% to 25.93%
271-360 days past due	32.45% to 42.66%
More than 360 days past due	100.00%

Age of receivables

	As at	As at	As at
	31 March 2021	31 March 2020	31 March 2019
within the credit period	2,363.97	1,830.89	1,881.48
1-90 days past due	706.26	697.56	541.11
91-180 days past due	57.54	48.47	252.71
181-270 days past due	7.69	7.90	21.87
271-360 days past due	13.49	4.15	11.36
More than 360 days past due	4.49	25.85	27.51
Total	3,153.44	2,614.82	2,736.04

The Group's exposure to credit and currency risk, and loss allowances related to trade receivables are disclosed in note 45.

13 Cash and cash equivalents

Particulars	As at	As at	As at
	31 March 2021	31 March 2020	31 March 2019
Cash on hand	0.72	1.14	1.00
Balance with banks			
- in current accounts	364.28	598.94	238.27
Total	365.00	600.08	239.27

14 Bank balances other than cash and cash equivalents

Particulars	As at	As at	As at
	31 March 2021	31 March 2020	31 March 2019
-In deposit accounts (due to mature within 12 months from the reporting date)*	286.42	116.36	76.73
Total	286.42	116.36	76.73

*Includes certain deposits pledged against bank guarantees and letter of credits provided by the bank.

15 Other current financial assets

Particulars	As at	As at	As at
	31 March 2021	31 March 2020	31 March 2019
Insurance claim receivable	-	106.50	99.78
Amounts recoverable from shareholders (Proposed IPO related) (refer note 41)	94.21	94.21	87.15
Unbilled revenue	50.31	15.99	34.33
Loan to key managerial personnel (refer note 41)	3.88	-	-
Loan to employees	25.38	10.62	10.58
Derivative contracts at fair value	38.54	-	17.08
Others	10.49	9.15	7.54
Total	222.81	236.47	256.46

16 Other current assets

Particulars	As at	As at	As at
	31 March 2021	31 March 2020	31 March 2019
Duty drawback receivables	71.61	102.08	92.87
Advance to suppliers	68.79	104.07	98.22
Balances with government authorities	172.63	211.79	286.70
Prepayments	18.90	27.78	37.57
Security deposits	-	-	1.01
Total	331.93	445.72	516.37

17 (a) **Equity share capital**

Particulars	As at		As at	
	31 March 2021	31 March 2020	31 March 2020	31 March 2019
Authorised				
Equity Shares				
62,500,000 (31 March 2020: 62,500,000; 31 March 2019: 62,500,000) equity shares of ₹ 2 each (31 March 2020: ₹ 2 each; 31 March 2019: ₹ 2 each)			125.00	125.00
Total			125.00	125.00
Issued, subscribed and paid up				
Equity shares				
46,936,500 (31 March 2020: 46,936,500; 31 March 2019: 46,936,500) equity shares of ₹ 2 each (31 March 2020: ₹ 2 each; 31 March 2019: ₹ 2 each)			93.87	93.87
Total			93.87	93.87

i. List of persons holding more than 5 percent equity shares

Name of the share holder	As at 31 March 2021		As at 31 March 2020		As at 31 March 2019	
	No of shares	% holding	No of shares	% holding	No of shares	% holding
Client Ebene Limited	15,343,900	32.69	15,343,900	32.69	15,343,900	32.69
CVCI GPII Employee Ebene Limited	8,593,425	18.31	8,593,425	18.31	8,593,425	18.31
S Sekhar Vasani	12,307,600	26.22	12,307,600	26.22	12,307,600	26.22
Unni Rajagopal K	3,416,925	7.28	3,416,925	7.28	3,416,925	7.28
D Devaraj *	3,416,925	7.28	3,416,925	7.28	3,416,925	7.28
F R Singhvi	3,416,925	7.28	3,416,925	7.28	3,416,925	7.28

*includes 669,175 shares held by D. Devaraj as the Kartha of a HUF.

ii. Reconciliation of the number of equity shares outstanding at the beginning and at the end of the year

Particulars	As at 31 March 2021		As at 31 March 2020		As at 31 March 2019	
	No of shares	Amount in ₹	No of shares	Amount in ₹	No of shares	Amount in ₹
Equity shares						
Number of shares outstanding at the beginning of the year	46,936,500	93.87	46,936,500	93.87	64,740	6.47
Add: Issued during the year (refer note (a) below)	-	-	-	-	46,871,760	87.40
Number of shares outstanding at the end of the year	46,936,500	93.87	46,936,500	93.87	46,936,500	93.87

Note:

a. During the financial year ended 31 March 2019, based on the shareholders' approval one equity share of ₹100 each was sub-divided into 50 equity shares of ₹2 each with effect from 27 July 2018. Subsequently, the Company had issued bonus shares in the proportion of 27:2.

iii. Shares held by holding / ultimate holding company and / or their subsidiaries / associates:

Name of the shareholder	As at 31 March 2021		As at 31 March 2020		As at 31 March 2019	
	No of shares	Amount in ₹	No of shares	Amount in ₹	No of shares	Amount in ₹
Equity shares						
Client Ebene Limited	15,343,900	30.69	15,343,900	30.69	15,343,900	30.69
CVCI GPII Employee Ebene Limited	8,593,425	17.19	8,593,425	17.19	8,593,425	17.19
Total	23,937,325	47.88	23,937,325	47.88	23,937,325	47.88

iv. As at March 31, 2021, the Company has reserved 2,362,050 shares (March 31, 2020 : 2,510,675 shares and March 31, 2019 : 2,510,675 shares) for issuance towards outstanding employee stock option granted/available for grant (Refer note 43)

v. Rights, preferences and restrictions attached to equity shares:

The Company has a single class of equity shares. Each holder of the equity share, as reflected in the records of the Company as of the date of the shareholder meeting, is entitled to one vote in respect of each share held for all matters submitted to vote in the Shareholders' meeting. The dividend, if any, proposed by the Board of Directors is subject to the approval of the shareholders in the ensuing Annual General Meeting.

In the event of liquidation of the Company, the holders of equity shares will be entitled to receive residual assets of the Company, after distribution of all preferential amounts, if any. The distribution will be in proportion to the number of equity shares held by the shareholders or in line with the terms of the shareholders agreement as the case may be. Each of the promoters undertake that until the earlier of an IPO or the holders of CCPS and / or their affiliates ceasing to hold any shares in the Company, no promoter shall directly or indirectly, transfer or grant options on any of shares held by them in the Company unless agreed to in writing by the holders of CCPS. The promoters of the Company are S Sekhar Vasani, F R Singhvi, Unni Rajagopal K and D Devaraj.

vi. There are no shares bought back during 5 years immediately preceding 31 March 2021.

vii. There have been no shares allotted as fully paid up pursuant to contract without payment being received in cash during five years immediately preceding 31 March 2021, except as stated in Note 17(a)(ii)(a).

17 (b) **Instruments entirely equity in nature**

Particulars	As at		As at	
	31 March 2021	31 March 2020	31 March 2020	31 March 2019
Authorised				
Preference shares				
A Series 300,000 (31 March 2020: 300,000; 31 March 2019: 300,000), 0.0001% compulsorily convertible preference shares of ₹100 each			30.00	30.00
B Series 750,000 (31 March 2020: 750,000; 31 March 2019: 750,000), 0.0001% compulsorily convertible preference shares of ₹100 each			75.00	75.00
Total			105.00	105.00
Issued, subscribed and paid up				
Preference shares				
A Series 300,000 (31 March 2020: 300,000; 31 March 2019: 300,000), 0.0001% compulsorily convertible preference shares of ₹100 each			30.00	30.00
B Series 750,000 (31 March 2020: 750,000; 31 March 2019: 750,000), 0.0001% compulsorily convertible preference shares of ₹100 each			75.00	75.00
Total			105.00	105.00

17 (b) Instruments entirely equity in nature (continued)

i. Reconciliation of the number of preference shares outstanding at the beginning and at the end of the year

Particulars	As at 31 March 2021		As at 31 March 2020		As at 31 March 2019	
	No of shares	Amount in ₹	No of shares	Amount in ₹	No of shares	Amount in ₹
Compulsorily Convertible Preference shares (CCPS) Series: A						
Number of shares outstanding at beginning of the year	300,000	30.00	300,000	30.00	300,000	30.00
Add: Issued during the year	-	-	-	-	-	-
Number of shares outstanding at the end of the year	300,000	30.00	300,000	30.00	300,000	30.00
Compulsorily Convertible Preference shares (CCPS) Series: B						
Number of shares outstanding at beginning of the year	750,000	75.00	750,000	75.00	750,000	75.00
Add: Issued during the year	-	-	-	-	-	-
Number of shares outstanding at the end of the year	750,000	75.00	750,000	75.00	750,000	75.00

ii. Shares held by holding / ultimate holding company and / or their subsidiaries / associates:

Particulars	As at 31 March 20		As at 31 March 2020		As at 31 March 2019	
	No of shares	Amount in ₹	No of shares	Amount in ₹	No of shares	Amount in ₹
Compulsorily Convertible Preference shares (CCPS) Series : A						
Client Ebene Limited	192,300	19.23	192,300	19.23	192,300	19.23
CVCIGPII Employee Ebene Limited	107,700	10.77	107,700	10.77	107,700	10.77
Total	300,000	30.00	300,000	30.00	300,000	30.00
Compulsorily Convertible Preference shares (CCPS) Series : B						
Client Ebene Limited	480,750	48.08	480,750	48.08	480,750	48.08
CVCIGPII Employee Ebene Limited	269,250	26.92	269,250	26.92	269,250	26.92
Total	750,000	75.00	750,000	75.00	750,000	75.00

iii. Rights, preferences and restrictions attached to preference shares:

Compulsorily convertible preference shares (CCPS) - [Series A and Series B]

Dividend rights

In accordance with the share subscription agreement dividend shall be equal to 0.0001% per annum of the face value of the CCPS [Series A and Series B]. In any given financial year, the Group may not declare any dividend or other distribution to its holders of equity shares unless it has first declared the preferential dividend for such financial year to the holders of the CCPS [Series A and Series B]. The dividends are non-cumulative.

Conversion of preference shares

In accordance with the share subscription agreement (SSA), CCPS [Series A and Series B] is convertible, on the expiry of 20 (twenty) years from the completion date respectively (July 7, 2033) and into a fixed share entitlement ratio as defined in the SSA.

The equity shares issued to the holders of the CCPS [Series A and Series B] pursuant to conversion shall be free of all encumbrances and shall (i) be fully-paid up, (ii) be transferable to any person in accordance with the terms of the agreement, (iii) carry full voting rights, and (iv) rank pari passu in every respect with other ordinary fully paid up equity shares.

18 Other equity

Summary of other equity balances*

Particulars	As at	As at	As at
	31 March 2021	31 March 2020	31 March 2019
Reserves and surplus			
Capital redemption reserve	0.55	0.55	0.55
Capital reserve	8.17	8.17	8.17
Securities premium	1,216.76	1,216.76	1,216.76
General reserve	135.48	135.48	135.48
Retained earnings	6,987.35	5,926.31	5,132.47
Employee stock option outstanding account	182.00	182.00	182.00
Exchange differences on translation of foreign operations	53.24	13.64	(20.48)
Total	8,583.55	7,482.91	6,654.95

* Refer restated consolidated statement of changes in equity for detailed movement in the above other equity balances.

Nature and purpose of other equity:

Capital redemption reserve

The capital redemption reserve is created out of undistributed profits for purchase of its own shares.

Capital reserve

Capital reserve of ₹3.52 million refers to subsidy received from the Government of Karnataka, Department of Industries and Commerce. This subsidy was received as the Group was a small scale industry in that particular year. Balance pertains to share of pre-acquisition profits of a subsidiary at the time of acquisition by the Group accounted as capital reserve.

Securities premium

Securities premium account comprises premium on issue of shares. The reserve is utilised in accordance with specific provision of the Companies Act, 2013.

General reserve

The general reserve is used from time to time to transfer profits from retained earnings for appropriation purposes. As the general reserve is created by a transfer from one component of equity to another and is not an item of other comprehensive income, items included in general reserve will not be reclassified subsequently to restated consolidated statement of profit and loss.

Retained earnings

Retained earnings are profits that the Group has earned till date, less any transfers to general reserve, dividends or other distributions paid to investors.

Employee stock option outstanding account

The fair value of the equity-settled share based payment transactions with employees is recognised in restated consolidated statement of profit and loss with corresponding credit to employee stock options outstanding account.

Exchange differences on translation of foreign operations

Exchange differences arising on translation of the foreign operations are recognised in other comprehensive income as described in accounting policy and accumulated in a separate reserve within equity. The cumulative amount is reclassified to profit or loss when the net investment is disposed off.

Sansera Engineering Limited (formerly known as Sansera Engineering Private Limited)
Notes to the restated consolidated financial information (continued)

19 **Non-current borrowings**

Particulars	As at	As at	As at
	31 March 2021	31 March 2020	31 March 2019
<i>Secured at amortised cost</i>			
Term loans from banks (refer note 26)	1,403.40	1,015.30	1,829.14
Term loans from other financial institutions (refer note 26)	472.81	701.65	304.70
Car loan from bank (refer note 26)	0.31	1.30	-
Total	1,876.52	1,718.25	2,133.84

For details of security, repayment terms and interest rate for non-current and current borrowings refer note 57

20 **Other non current financial liabilities**

Particulars	As at	As at	As at
	31 March 2021	31 March 2020	31 March 2019
Capital creditors	-	11.04	76.87
Total	-	11.04	76.87

21 **Non-current provision**

Particulars	As at	As at	As at
	31 March 2021	31 March 2020	31 March 2019
Provision for employee benefits			
Provisions for gratuity (refer note 42)	151.83	126.89	85.83
Total	151.83	126.89	85.83

22 **Deferred tax liabilities, net**

Particulars	As at	As at	As at
	31 March 2021	31 March 2020	31 March 2019
Deferred tax assets			
Provision for employee benefits	60.86	57.69	50.91
Security deposit	1.06	2.12	3.17
Allowance for credit losses	4.58	4.58	8.78
Derivative contracts at fair value	-	5.01	-
Right of use assets, net of lease liabilities (Ind AS 116)	8.81	7.31	11.32
Others	2.63	9.66	2.52
Total (a)	77.94	86.37	76.70
Deferred tax liabilities			
Excess of depreciation on property, plant and equipment under Income Tax Act, 1961 over depreciation under Companies Act.	671.46	633.67	769.88
On fair valuation of quoted investments	1.40	0.89	1.86
Derivative contracts at fair value	9.70	-	-
On fair valuation of prepaid rent	-	-	2.83
On Intangibles	-	4.08	5.11
Exchange differences arising from foreign operations	13.32	-	-
Others	0.04	-	-
Total (b)	695.92	638.64	779.68
Deferred tax liabilities (net) (c) = (b) - (a)	617.98	552.27	702.98

23 **Other non-current liability**

Particulars	As at	As at	As at
	31 March 2021	31 March 2020	31 March 2019
Deferred government grant	467.16	425.89	421.34
Total	467.16	425.89	421.34

Movement in deferred government grant (Current and Non-current)

Particulars	As at	As at	As at
	31 March 2021	31 March 2020	31 March 2019
Opening balance	467.04	457.15	295.60
Add: Grants received during the year	92.67	50.78	186.60
Less: Amortised to profit or loss	(45.11)	(40.89)	(25.05)
Closing balance	514.60	467.04	457.15
Less: Amounts expected to be recognised in the next 12 months (refer note 28) - current	47.44	41.15	35.81
Net Closing balance, non-current	467.16	425.89	421.34

The government grant related to property, plant and equipment is recognised as deferred income and is being amortised over the useful life of the asset in proportion in which the related depreciation expense is recognised. Refer note 3 (a).

24 **Current borrowings**

Particulars	As at	As at	As at
	31 March 2021	31 March 2020	31 March 2019
Loans repayable on demand - Unsecured			
From bank	-	100.00	100.00
From others	-	450.50	257.60
Loans from banks-Secured			
Cash credit	40.95	-	437.31
Working capital loan	1,518.58	1,453.15	977.38
Packing credit	992.79	1,525.28	578.48
Bill discounting facility with recourse	-	25.19	27.50
Foreign currency loan	-	-	464.81
Loans from others-Secured			
Working capital loan	-	-	200.00
Total	2,552.32	3,554.12	3,043.08

For details of security, repayment terms and interest rate for non-current and current borrowings refer note 57.

Sansera Engineering Limited (formerly known as Sansera Engineering Private Limited)
Notes to the restated consolidated financial information (continued)

25 Trade payables

Particulars	As at	As at	As at
	31 March 2021	31 March 2020	31 March 2019
Total outstanding dues of micro enterprises and small enterprises (refer note 47)	86.39	67.23	91.18
Total outstanding dues of creditors other than to micro enterprises and small enterprises	1,750.37	1,334.97	1,411.44
Trade payable towards			
Accrued salaries and benefits *	385.22	263.55	322.91
Accrued expenses	48.48	63.20	40.11
Total	2,270.46	1,728.95	1,865.64

The Group's exposure to currency and liquidity risk related to trade payables are disclosed in note 45.

The average credit period on purchase of goods for the financial year ended 31 March 2021 are 55 days. No interest is charged on the trade payable. The Group has financial risk management policies in place to ensure that all payables are paid within pre-agreed credit terms

* Includes payable to directors (refer note 41)

26 Other current financial liabilities

Particulars	As at	As at	As at
	31 March 2021	31 March 2020	31 March 2019
Current maturities of non-current borrowings*	1,053.72	1,095.40	776.71
Capital creditors**	168.02	103.02	225.65
Derivative contracts at fair value	-	19.89	-
Accrued interest	14.93	-	-
Total	1,236.67	1,218.31	1,002.36

*For details of security, repayment terms and interest rate for non-current and current borrowings refer note 57.

**Capital creditors include dues to micro enterprises and small enterprises amounting to ₹ 25.00 million (31 March 2020: ₹ 8.60 million ; 31 March 2019 ₹ 8.84 million); (Refer note 47).

27 Current provisions

Particulars	As at	As at	As at
	31 March 2021	31 March 2020	31 March 2019
Provision for employee benefits			
Provision for gratuity (refer note 42)	26.75	20.71	16.12
Provision for compensated absences	72.35	77.83	49.30
Total	99.10	98.54	65.42

28 Other current liabilities

Particulars	As at	As at	As at
	31 March 2021	31 March 2020	31 March 2019
Advance from customers	26.37	12.96	11.96
Statutory liability	133.82	110.38	89.83
Deferred government grant (refer note 23)	47.44	41.15	35.81
Total	207.63	164.49	137.60

Sansera Engineering Limited (formerly known as Sansera Engineering Private Limited)
Notes to the Restated Consolidated Financial Information (continued)

(Amount in ₹ millions)

29 Revenue from operations

Particulars	For the year ended 31 March 2021	For the year ended 31 March 2020	For the year ended 31 March 2019
Sale of products	14,568.90	13,930.38	15,269.81
Sale of services	2.30	13.02	125.00
	14,571.20	13,943.40	15,394.81
Other operating revenue:			
- Scrap sales	560.14	441.74	598.56
- Tooling income	257.85	54.90	104.70
- Export incentive benefit	103.52	131.66	146.23
Total	15,492.71	14,571.70	16,244.30

A. Disaggregation of revenue from contracts with customers	For the year ended 31 March 2021	For the year ended 31 March 2020	For the year ended 31 March 2019
--	-------------------------------------	-------------------------------------	-------------------------------------

Sale of products			
- India	9,466.78	9,664.83	10,536.15
- Europe	3,640.52	3,266.21	3,682.89
- USA	1,012.62	709.86	902.00
- Other foreign countries	448.98	289.48	148.77
Total	14,568.90	13,930.38	15,269.81

Sale of services			
- India	2.30	13.02	125.00

Tooling income			
- India	47.29	2.08	24.42
- Europe	105.90	42.26	51.30
- USA	90.07	10.56	28.98
- Other foreign countries	14.59	-	-
Total	257.85	54.90	104.70

Total revenue from contracts with customers			
- India	9,516.37	9,679.93	10,685.57
- Europe	3,746.42	3,308.47	3,734.19
- USA	1,102.69	720.42	930.98
- Other foreign countries	463.57	289.48	148.77
Total	14,829.05	13,998.30	15,499.51

B. Reconciling the amount of revenue recognised with contract and total revenue:

Particulars	For the year ended 31 March 2021	For the year ended 31 March 2020	For the year ended 31 March 2019
Total revenue from contract with customers	14,829.05	13,998.30	15,499.51
Adjustments:			
Other operating revenues:			
- Export incentive benefit	103.52	131.66	146.23
- Scrap sales	560.14	441.74	598.56
Total	15,492.71	14,571.70	16,244.30

C. Timing of revenue recognition

Particulars	For the year ended 31 March 2021	For the year ended 31 March 2020	For the year ended 31 March 2019
Good transferred at a point in time	15,234.86	14,516.80	16,139.60
Service transferred over time	257.85	54.90	104.70
Total revenue from contract with customers	15,492.71	14,571.70	16,244.30

D. Contract balances

Particulars	For the year ended 31 March 2021	For the year ended 31 March 2020	For the year ended 31 March 2019
Trade receivables	3,129.83	2,591.21	2712.43
Contract assets (Unbilled revenue)	50.31	15.99	34.33
Contract liabilities (Advance from customers)	26.37	12.96	11.96

E. The Group's revenue from its major products are as follows:

Particulars	For the year ended 31 March 2021	For the year ended 31 March 2020	For the year ended 31 March 2019
Connecting rods	5,778.67	5,213.35	5,867.27
Crank shaft assembly	2,509.90	2,531.40	2,878.08
Gear shifter forks	959.06	1,003.85	1,277.60
Rocker arms	2,836.10	2,899.88	2,999.31
Others*	2,485.17	2,281.90	2,247.55
Total revenue from sale of products	14,568.90	13,930.38	15,269.81

* Individual items of these are less than 10% of sale of products.

Revenue from sale of products from three customers (31 Mar 2020: two customers) (31 Mar 2019: three customers) of the Group is ₹ 6,547.26 million (31 March 2020 ₹ 4,992.19) (31 March 2019 ₹ 6,916.18) which is individually more than 10% of the Group's sale of products.

30 Other income

Particulars	For the year ended 31 March 2021	For the year ended 31 March 2020	For the year ended 31 March 2019
Interest income	22.42	10.87	5.77
Fair value gain on financial instruments at fair value through profit or loss	2.05	-	-
Profit on sale of property, plant and equipments, net	4.77	1.05	-
Gain on foreign currency transactions, net	101.80	104.64	118.73
Income from government grants	81.92	40.89	25.05
Other non-operating income	17.97	2.24	14.24
Total	230.93	159.69	163.79

31 Cost of materials consumed

Particulars	For the year ended 31 March 2021	For the year ended 31 March 2020	For the year ended 31 March 2019
Raw materials at the beginning of the year	722.90	772.26	616.76
Add: Purchases	6,793.44	6,232.63	7,375.52
Less: Raw materials at the end of the year	838.03	722.90	772.26
Total	6,678.31	6,281.99	7,220.02

32 Changes in inventories of finished goods and work-in-progress

Particulars	For the year ended 31 March 2021	For the year ended 31 March 2020	For the year ended 31 March 2019
Opening balance			
Finished goods	369.27	322.87	276.40
Work-in-progress	879.62	907.07	786.53
	1,248.89	1,229.94	1,062.93
Closing balance			
Finished goods	395.15	369.27	322.87
Work-in-progress	897.45	879.62	907.07
	1,292.60	1,248.89	1,229.94
Changes in inventories of work-in-progress and finished goods	(43.71)	(18.95)	(167.01)

Sansera Engineering Limited (formerly known as Sansera Engineering Private Limited)
Notes to the Restated Consolidated Financial Information (continued)

(Amount in ₹ millions)

33 Employee benefit expenses

Particulars	For the year ended	For the year ended	For the year ended
	31 March 2021	31 March 2020	31 March 2019
Salaries and wages*	1,804.31	1,819.53	1,840.57
Contribution to provident and other funds (refer note 42 A)	75.96	82.27	80.82
Gratuity expenses (refer note 42 B)	39.79	34.36	25.98
Employee stock compensation expense**	-	-	4.47
Staff welfare expenses	217.44	198.08	222.23
Total	2,137.50	2,134.24	2,174.07

* Includes expenses towards leave encashment of ₹ 41.06 million (31 March 20: ₹ 48.86 million ; 31 March 2019: ₹ 36.30 million)

**Employee stock compensation expense does not include any expense (31 March 2020: Nil; 31 March 2019: ₹ 4.47) towards stock options issued at intrinsic value. Also refer note 43.

34 Finance costs

Particulars	For the year ended	For the year ended	For the year ended
	31 March 2021	31 March 2020	31 March 2019
Interest Cost			
-Banks	335.24	374.99	363.53
-Others	92.83	119.67	81.94
Foreign exchange loss to the extent considered as borrowing costs	4.06	46.68	36.27
Interest and finance charges on lease liabilities	41.80	39.56	31.07
Total	473.93	580.90	512.81

35 Depreciation and amortisation expenses

Particulars	For the year ended	For the year ended	For the year ended
	31 March 2021	31 March 2020	31 March 2019
Depreciation of property plant and equipment	930.36	857.10	697.47
Depreciation of right-of-use-asset	79.56	75.08	53.25
Amortisation of intangible assets	6.84	6.82	6.82
Total	1,016.76	939.00	757.54

36 Other expenses

Particulars	For the year ended	For the year ended	For the year ended
	31 March 2021	31 March 2020	31 March 2019
Contract labour charges	771.14	689.87	625.46
Freight outward	168.15	114.89	126.22
Legal and professional (refer note 39 and 41)	71.14	77.27	108.81
Rates and taxes	45.77	18.11	14.51
Repairs and maintenance			
-building	103.51	115.19	93.56
-computers	51.93	56.05	40.39
-vehicles	25.74	29.05	25.87
Rent	3.08	4.84	6.60
Traveling and conveyance	20.45	50.67	58.35
Insurance	54.65	40.24	38.92
Printing and Stationery	5.56	6.18	9.94
Communication	8.69	8.40	13.52
Security charges	44.97	44.70	44.81
Selling and advertisement	1.43	4.80	8.15
Corporate social responsibility (refer note 48)	29.53	30.00	14.38
Loss allowance on trade receivables	-	-	0.50
Loss on sale of property, plant and equipments, net	-	-	2.51
Insurance claim receivable written off	11.26	10.50	9.23
Bank charges	21.55	26.41	27.49
Miscellaneous	28.25	52.18	40.60
Total	1,466.80	1,379.35	1,309.82

37 Earnings Per Share (EPS)

(Amount in ₹ millions except no. of shares)

Basic earnings per share is calculated by dividing the profit for the year available to the shareholders of the Company by the weighted average number of equity shares outstanding during the year. The weighted average number of equity shares includes the equity shares to be issued upon conversion of Compulsorily Convertible Preference shares. Diluted earnings per share is calculated by dividing the profit for the year by the weighted average number of equity shares outstanding during the year, after adjustment for the effects of all dilutive potential equity shares. The details are as follows:

Particulars		As at	As at	As at
		31 March 2021	31 March 2020	31 March 2019
Profit for the year available to the shareholders of the Company	A	1,079.86	803.10	962.13
Nominal value of equity shares (₹ per share)		2	2	2
Weighted average number of equity shares for calculation of basic earnings per share	B	51,377,850	51,377,850	51,377,850
Basic earnings per share (in ₹)	A/B	21.02	15.63	18.73
Weighted average number of equity shares for calculation of diluted earnings per share	C	52,551,625	52,551,625	52,551,625
Diluted earnings per share (in ₹)	A/C	20.55	15.28	18.31

Note : Basic Earning Per Share have been restated to include the impact of compulsorily convertible preference shares outstanding as at March 31, 2020 and 2019, which was not considered earlier. There is no change in the diluted earnings per share.

Computation of weighted average number of shares

Particulars	As at	As at	As at
	31 March 2021	31 March 2020	31 March 2019
Weighted average number of equity shares	46,936,500	46,936,500	46,936,500
Weighted average number of Compulsorily Convertible Preference Shares (CCPS) Series:A	4,439,900	4,439,900	4,439,900
Weighted average number of Compulsorily Convertible Preference Shares (CCPS) Series:B	1,450	1,450	1,450
Weighted average number of equity shares for calculation of basic earnings per share	51,377,850	51,377,850	51,377,850
Add: Impact of potentially dilutive equity shares:-			
Employee Stock Option Plan	1,173,775	1,173,775	1,173,775
Weighted average number of equity shares for calculation of diluted earnings per share	52,551,625	52,551,625	52,551,625

The company in its meeting held on 3rd September 2021 converted 300,000 Series A Compulsorily Convertible Preference Shares into 4,439,900 equity shares and converted 750,000 Series B Compulsorily Convertible Preference Shares into 1,450 equity shares.

38 Contingent liabilities and commitments (to the extent not provided for)

Particulars	As at	As at	As at
	31 March 2021	31 March 2020	31 March 2019
Contingent liabilities #			
Claims against the Group not acknowledged as debts:-			
Customer claims (refer note A)	-	-	5.79
Excise duty, entry tax and service tax matters (refer note B)	80.35	82.54	71.94
Income tax matters (refer note B)	11.98	12.01	5.62
Commitments ##			
Estimated amount of contracts remaining to be executed on capital account and not provided for (refer note C)	398.56	194.24	567.82

Note A: These are claims raised by the customers against the Group in respect of products supplied. The claim from the customer for the year ended 31 March 2021 is Nil (31 March 2020: Nil ; 31 March 2019: ₹ 5.79 million).

Note B: Pending resolution of the respective proceedings, it is not practicable for the Group to estimate the timings of cash flows, if any, in respect of the above as it is determinable only on receipt of judgements/decisions pending with various forums/authorities. The Group has reviewed all its pending litigations and proceedings and has adequately provided for wherever required and disclosed as contingent liabilities where applicable, in its restated consolidated financial information. The Group does not expect the outcomes of these proceedings to have a materially adverse effect on its financial position.

Note C: As at 31 March 2021, the Group has committed to spend ₹ 398.56 million (31 March 2020 ₹ 194.24 million; 31 March 2019 ₹ 567.82 million) under contract to purchase property, plant and equipment.

The Supreme court of India in the month of February 2019 had passed a judgement relating to definition of wages under the Provident Fund Act, 1952. However, considering that there are numerous interpretative issues relating to this judgement and in the absence of reliable measurement of the provision for the earlier periods, the Group had made a provision for provident fund contribution pursuant to the judgement in the previous year. The Group will evaluate its position and update its provision, if required, on receiving further clarity on the subject. The Group does not expect any material impact of the same.

The Group has invested in Cleanmax Vega Power LLP (i.e., power producer) and entered into a energy supply agreement for a period of 25 years with lock in period of 5 years pursuant to such energy supply agreement the Group has committed to purchase at least 51% of the total power produced by the power producer. (refer note 5)

The Group does not have any other material commitments.

(Amount in ₹ millions)

39 Auditors' remuneration, net of taxes (included in legal and professional)

Particulars	For the year ended 31 March	For the year ended 31	For the year ended 31
	2021	March 2020 #	March 2019 #
Statutory audit fees	3.80	3.40	3.40
Statutory audit fees-Erstwhile auditor	0.59	-	-
Tax audit fees	0.30	0.40	0.40
Tax audit fees-Erstwhile auditor	0.04	-	-
Other Audit Services	-	0.26	18.49
Reimbursement of expenses	-	0.66	2.00
Total	4.73	4.72	24.29

represents payment made to the erstwhile auditors of the Company

40 Tax expense

A. Amounts recognised in the restated consolidated statement of profit and loss

Particulars	For the year ended 31 March 2021	For the year ended 31 March 2020	For the year ended 31 March 2019
Current tax (a)			
Current year	303.87	235.05	492.55
Deferred tax (b)			
<i>Attributable to -</i>			
Origination and reversal of temporary differences	58.98	(147.34)	176.32
Income tax expense reported in the consolidated statement of profit or loss (a+b)	362.85	87.71	668.87

Amounts recognised in other comprehensive income

Particulars	For the year ended 31 March 2021	For the year ended 31 March 2020	For the year ended 31 March 2019
Deferred taxes			
Remeasurements of the defined benefit plans	(6.59)	(3.37)	(1.02)
Exchange differences on translation of foreign operations	13.32	-	-
Total	6.73	(3.37)	(1.02)

B. Bifurcation of the income tax recognised in other comprehensive income into

Particulars	For the year ended 31 March 2021	For the year ended 31 March 2020	For the year ended 31 March 2019
Items that will not be reclassified to profit or loss	(6.59)	(3.37)	(1.02)
Items that will be reclassified to profit or loss	13.32	-	-
Total	6.73	(3.37)	(1.02)

C. Reconciliation of the income tax provision to the amount computed by applying the statutory income tax rate to the income before income taxes is summarized below:

	31 March 2021	31 March 2020	31 March 2019
Profit before tax	1,461.45	886.76	1,649.51
Tax using the Group's domestic tax rate	25.17%	25.17%	34.94%
	367.85	223.20	576.41
Effect of:			
Non-deductible expenses	7.29	7.55	4.12
Incremental tax expense on completion of assessment for earlier years	(4.44)	26.04	25.16
Difference in rate from previous years*	-	(191.15)	1.85
Tax on exempt income	(13.19)	-	(5.17)
Difference in domestic and overseas rate	-	(2.13)	(6.51)
Current year losses for which no deferred tax was recognised	-	2.64	70.20
Impact of implementation of IND AS 116	-	7.31	-
Others	5.34	14.25	2.81
Income tax expense **	362.85	87.71	668.87

*w.e.f 1 Apr 2019, the new Section 115BAA was inserted in Income Tax, 1961 which prescribed the concessional tax rates of 22% (with 10% of Surcharge and 4% of cess) as against the erstwhile rates of 30% (with 12% of Surcharge and 4% of cess). The Company has accordingly adopted the concessional tax rates which has resulted in reversal of deferred tax amounting to ₹ 191.15 million during previous year.

** Income tax expense does not include deferred tax recognised in other comprehensive income

D. Movement in temporary differences

Particulars	Balance as at 1 April 2020 Net deferred tax asset/(liabilities)	Recognised in profit and loss during the year	Recognised in OCI during the year	Impact on account of IND AS 116	Balance as at 31 March 2021 Net deferred tax asset/(liabilities)
Excess of depreciation on property, plant and equipment under Income Tax Act, 1961 over depreciation under Companies Act.	(633.67)	(37.79)	-	-	(671.46)
Provision for employee benefits	57.69	(3.42)	6.59	-	60.86
Security deposit	2.12	(1.06)	-	-	1.06
Allowance for credit losses	4.58	0.00	-	-	4.58
On fair valuation of quoted investments	(0.89)	(0.51)	-	-	(1.40)
On fair valuation of prepaid rent	-	-	-	-	-
Others	9.66	(7.07)	-	-	2.59
Derivative contracts	5.01	(14.71)	-	-	(9.70)
Right of use assets, net of lease liabilities (Ind AS 116)	7.31	1.50	-	-	8.81
Exchange difference on foreign operations	-	-	(13.32)	-	(13.32)
On Intangibles	(4.08)	4.08	-	-	0.00
Total	(552.27)	(58.98)	(6.73)	-	(617.98)

Particulars	Balance as at 1 April 2019 Net deferred tax asset/(liabilities)	Recognised in profit and loss during the year	Recognised in OCI during the year	Impact on account of IND AS 116	Balance as at 31 March 2020 Net deferred tax asset/(liabilities)
Excess of depreciation on property, plant and equipment under Income Tax Act, 1961 over depreciation under Companies Act.	(769.88)	136.21	-	-	(633.67)
Provision for employee benefits	50.91	3.41	3.37	-	57.69
Security deposit	3.17	(1.05)	-	-	2.12
Allowance for credit losses	8.78	(4.20)	-	-	4.58
On fair valuation of quoted investments	(1.86)	0.97	-	-	(0.89)
On fair valuation of prepaid rent	(2.83)	2.83	-	-	-
Others	2.52	7.14	-	-	9.66
Derivative liability	-	5.01	-	-	5.01
Right of use assets, net of lease liabilities (Ind AS 116)	11.32	(4.01)	-	-	7.31
On Intangibles	(5.11)	1.03	-	-	(4.08)
Total	(702.98)	147.34	3.37	-	(552.27)

Particulars	Balance as at 1 April 2018 Net deferred tax asset/(liabilities)	Recognised in profit and loss during the year	Recognised in OCI during the year	Impact on account of IND AS 116	Balance as at 31 March 2019 Net deferred tax asset/(liabilities)
Excess of depreciation on property, plant and equipment under Income Tax Act, 1961 over depreciation under Companies Act.	(572.07)	(197.81)	-	-	(769.88)
Provision for employee benefits	33.97	15.92	1.02	-	50.91
Security deposit	0.28	2.89	-	-	3.17
Allowance for credit losses	7.50	1.28	-	-	8.78
Others	-	2.52	-	-	2.52
On fair valuation of quoted investments	-	(1.86)	-	-	(1.86)
On fair valuation of prepaid Rent	-	(2.83)	-	-	(2.83)
Right of use assets, net of lease liabilities (Ind AS 116)	-	2.55	-	8.77	11.32
On Intangibles	(6.13)	1.02	-	-	(5.11)
Total	(536.45)	(176.32)	1.02	8.77	(702.98)

Sansera Engineering Limited (formerly known as Sansera Engineering Private Limited)
Notes to the Restated Consolidated Financial Information (continued)

41 Related parties disclosures

A. Significant Shareholders

Client Ebene Limited
CVCIGPII Employee Ebene Limited

B. Trust in which the Director is a trustee

Sansera Foundation

C. Partnership firm in which the Directors are partners

Singhvi Dev & Unni (upto 6 June 2018)

D. Key managerial personnel

S Sekhar Vasam - Chairman and Managing Director
F R Singhvi - Chief Financial Officer (With effect from 5 April 2019 upto 5 August 2019)
F R Singhvi - Joint Managing Director (With effect from 6 August 2019)
Unni Rajagopal - Director (upto 6 August 2019)
B R Preetham - Chief Executive Officer
S Ramakrishnan - Chief Financial Officer (upto 17 January 2019)
Vikas Goel - Chief Financial Officer (With effect from 6 August 2019)
Sourabh Kumar - Company Secretary (upto 6 February 2019)
Rajesh Kumar Modi - Company Secretary (With effect from 6 February 2019)
Muthuswami Lakshminarayan - Independent Director
Revathy Ashok - Independent Director
Bilaine Sylvain - Independent Director

E. Close member of key managerial personnel's family

Lalitha Singhvi
Praveen Singhvi
Lata Singhvi
Jayaraj Singhvi
Tara Singhvi
Indira Singhvi

F. The following is the summary of related party transactions

(Amount in ₹ millions)

Particulars	For the year ended 31 March 2021	For the year ended 31 March 2020	For the year ended 31 March 2019
Expenditure towards Corporate Social Responsibility (CSR)			
Sansera Foundation	20.32	27.50	14.25
Legal and professional charges			
Singhvi Dev & Unni	-	-	0.20
Issue of shares - Subdivision and Bonus issue			
Client Ebene Limited	-	-	30.69
CVCIGPII Employee Ebene Limited	-	-	17.19
S Sekhar Vasam	-	-	24.62
Unni Rajagopal	-	-	6.83
F R Singhvi	-	-	6.83
Lalitha Singhvi	-	-	0.10
Praveen Singhvi	-	-	0.15
Lata Singhvi	-	-	0.15
Jayaraj Singhvi	-	-	0.16
Tara Singhvi	-	-	0.16
Indira Singhvi	-	-	0.16
IPO expenses incurred (to be reimbursed by the shareholders)			
S. Sekhar Vasam	-	0.84	10.40
Lalitha Singhvi	-	0.02	0.31
Praveen Singhvi	-	0.04	0.52
Lata Singhvi	-	0.04	0.52
Jayaraj Singhvi	-	0.04	0.52
Tara Singhvi	-	0.04	0.52
Indira Singhvi	-	0.04	0.52
Unni Rajagopal	-	0.23	2.89
Devappa Devaraj	-	0.19	2.32
Devappa Devaraj on behalf of D. Devaraj HUF	-	0.04	0.57
Client Ebene Limited	-	3.55	43.63
CVCIGP II Employee Ebene Limited	-	1.99	24.43

41 Related parties disclosures (continued)

(Amount in ₹ millions)

F. The following is the summary of related party transactions (continued)

Particulars	For the year ended 31 March 2021	For the year ended 31 March 2020	For the year ended 31 March 2019
Managerial Remuneration*			
S Sekhar Vasan	7.45	14.89	14.89
F R Singhvi	7.45	14.73	2.94
B R Preetham	11.47	13.21	13.83
S Ramakrishnan	-	-	10.27
Vikas Goel	11.80	9.54	-
Sourabh Kumar	-	-	1.96
Rajesh Kumar Modi	3.46	3.57	0.96
Muthuswami Lakshminarayan	0.60	1.20	0.90
Revathy Ashok	0.60	1.20	0.90
Bilaine Sylvain	0.53	1.20	0.89
Sitting fees			
Muthuswami Lakshminarayan	0.11	0.13	0.20
Revathy Ashok	0.16	0.21	0.21
Bilaine Sylvain	0.15	0.14	0.10
Reimbursement of expenses			
Bilaine Sylvain	-	0.04	0.04

*Excludes contribution to employee retirement/post retirement and other employee benefits which are based on actuarial valuation done on an overall Company basis.

G. The balances receivable from and payable to related parties are:

Particulars	As at 31 March 2021	As at 31 March 2020	As at 31 March 2019
IPO expenses recoverable from shareholders*			
S. Sekhar Vasan	11.24	11.24	10.40
Lalitha Singhvi	0.33	0.33	0.31
Praveen Singhvi	0.56	0.56	0.52
Lata Singhvi	0.56	0.56	0.52
Jayaraj Singhvi	0.56	0.56	0.52
Tara Singhvi	0.56	0.56	0.52
Indira Singhvi	0.56	0.56	0.52
Unni Rajagopal	3.12	3.12	2.89
Devappa Devaraj	2.51	2.51	2.32
Devappa Devaraj on behalf of D. Devaraj HUF	0.61	0.61	0.57
Client Ebene Limited	47.18	47.18	43.63
CVCIGP II Employee Ebene Limited	26.42	26.42	24.43
Loan to key managerial personnel			
B R Preetham	3.88	3.88	2.88
Payable to Directors			
S. Sekhar Vasan	12.87	10.83	10.34
F R Singhvi	1.94	2.25	0.25

* The management of the Company, vide its board resolution dated June 11, 2018, decided to list the Company through "offer for sale of securities by certain shareholders".

In accordance with the plan, the Company had filed its DRHP on August 10, 2018. However due to downturn in the Automotive industry and the consequent pandemic resulted in the Company deferring the plan of its listing till 31 March 2022. The DRHP filed got expired on November 12, 2019.

For the purpose of IPO, during the current financial year, the Company has incurred a cost of Nil (31 Mar 2020: ₹ 7.06 million; 31 Mar 2019: ₹ 87.15 million) and cost incurred till date is ₹ 94.21 million (31 Mar 2020: ₹ 94.21 million; 31 Mar 2019: ₹ 87.15 million). As per the arrangement with the related Shareholders, the aforesaid expenditure is required to be borne by the respective Shareholders. The Company accordingly has obtained a confirmation from the respective Shareholders and has shown these amounts as recoverable from them.

There has been no instance of provision, write off and write back of the cost incurred by Group.

Terms and conditions:

All transactions with these related parties are at arm's length basis and none of the balances are secured.

Refer note 56 for transactions within the group.

42 Gratuity

A Defined contribution plan

The Group has defined contribution plan. Contributions are made to the Provident fund for employees at the specified rate of basic salary as per regulations. The contributions are made to registered provident fund administered by the government. The obligation of the Group is limited to the amount contributed and it has no further contractual nor any constructive obligation.

Particulars	For the year ended 31 March 2021	For the year ended 31 March 2020	For the year ended 31 March 2019
-Employer contribution to Provident fund, including admin charges	63.51	68.80	59.36
-Employer contribution to Employee state insurance scheme	10.44	13.18	19.12
-Employer contribution to Labour Welfare Fund	2.01	0.29	2.34

B Defined benefit plans

The Group sponsors funded defined benefit plans for qualifying employees. The defined benefit plans are administered by a separate Fund that is legally separated from the entity. The benefit vests upon completion of five years of continuous service and once vested it is payable to employees on retirement (age of 58 years) or on termination of employment. In case of death while in service, the gratuity is payable irrespective of vesting. The Group makes annual contribution to the Fund.

The following table sets out the status of the gratuity plan as required under Ind AS 19 "Employee benefits":

a) Reconciliation of present value of defined benefit obligation

Particulars	As at 31 March 2021	As at 31 March 2020	As at 31 March 2019
Defined benefit obligation at the beginning of the year	293.57	241.61	207.12
Current service cost	29.37	20.59	20.28
Current interest cost	19.79	18.65	15.94
Benefits paid	(9.02)	(5.98)	(4.60)
Past service cost	-	5.90	-
Actuarial (gains)/ losses recognised in other comprehensive income			
Changes in demographic assumptions	-	(0.11)	(4.62)
Changes in financial assumptions	-	12.00	(21.33)
Experience adjustments	23.66	0.92	28.82
Defined benefit obligation at the end of the year	357.37	293.57	241.61

b) Reconciliation of present value of plan assets

Particulars	As at 31 March 2021	As at 31 March 2020	As at 31 March 2019
Plan assets at the beginning of the year	145.97	139.66	133.14
Contribution paid into the plan	32.47	-	-
Benefits paid	(6.28)	(4.13)	(3.64)
Interest income	9.37	10.78	10.24
Return on plan assets recognised in other comprehensive income	(2.74)	(0.35)	(0.08)
Plan assets at the end of the year	178.79	145.97	139.66
Net defined benefit liability (a-b)	178.58	147.60	101.95
Non-current	151.83	126.89	85.83
Current	26.75	20.71	16.12
Total	178.58	147.60	101.95

c) Expense recognised in the restated consolidated statement of profit and loss

Particulars	For the year ended 31 March 2021	For the year ended 31 March 2020	For the year ended 31 March 2019
Current service cost	29.37	20.59	20.28
Interest cost	19.79	18.65	15.94
Interest income	(9.37)	(10.78)	(10.24)
Past service cost	-	5.90	-
Total	39.79	34.36	25.98

d) Remeasurements recognised in Other Comprehensive Income (OCI)

Particulars	For the year ended 31 March 2021	For the year ended 31 March 2020	For the year ended 31 March 2019
Actuarial loss on account of experience adjustments	23.20	0.92	28.82
Actuarial (gain)/loss arising from change in demographic assumptions	-	(0.11)	(4.62)
Actuarial (gain)/loss arising from change in financial assumptions	-	12.00	(21.33)
Return on plan assets recognised in other comprehensive income	2.74	0.35	0.08
Total	25.94	13.16	2.95

e) Actuarial assumptions

The following table sets out the status of the Gratuity scheme and the amount recognised in the financial statements as per the Actuarial Valuation done by an Independent Actuary. These plans typically expose the Group to actuarial risks such as: investment risk, interest rate risk, longevity risk and salary risk.

Investment risk	The present value of the defined benefit plan liability is calculated using a discount rate which is determined by reference to market yields at the end of the reporting period on government bonds. When there is a deep market for such bonds; if the return on plan asset is below this rate, it will create a plan deficit.
Interest risk	A decrease in the bond interest rate will increase the plan liability.
Longevity risk	The present value of the defined benefit plan liability is calculated by reference to the best estimate of the mortality of plan participants both during and after their employment. An increase in the life expectancy of the plan participants will increase the plan's liability.
Salary risk	The present value of the defined benefit plan liability is calculated by reference to the future salaries of plan participants. As such, an increase in the salary of the plan participants will increase the plan's liability.

In respect of the above plans, the most recent actuarial valuation of the present value of the defined benefit obligation were carried out as at 31 March 2021 by an independent member firm of the Institute of Actuaries of India. The present value of the defined benefit obligation, and the related current service cost and past service cost, were measured using the projected unit credit method.

42 Gratuity (continued)

(Amount in ₹ millions)

The principal assumptions used for the purpose of the actuarial valuations were as follows:

Particulars	For the year ended	For the year ended	For the year ended
	31 March 2021	31 March 2020	31 March 2019
Discount rate	6.75%	6.75%	7.70%
Salary increase**	4%-5%	4%-5% *	4%-6%
Mortality Rate	100% of IALM 2012-14	100% of IALM 2012-14	IALM (2006-08)
Retirement age	58 years	58 years	58 years
Withdrawal Rate	4.00%	4.00%	5.00%

* Salary increment for the financial year ended 31 March 2021 was considered as 0% due to COVID-19 effect.

**The estimate of future salary increases, considered in actuarial valuation, takes account of inflation, seniority, promotion and other relevant factors, such as supply and demand in the employment market.

f) Sensitivity Analysis

Reasonably possible changes at the reporting date to one of the relevant actuarial assumptions, holding other assumptions constant, would have affected the defined benefit obligation by the amounts shown below:

Particulars	For the year ended		For the year ended		For the year ended	
	31 March 2021		31 March 2020		31 March 2019	
	Increase	Decrease	Increase	Decrease	Increase	Decrease
Discount rate (1% movement)	325.42	(394.32)	266.51	(324.96)	218.69	(266.82)
Future salary growth (1% movement)	394.64	(324.61)	324.40	(266.18)	265.20	(219.52)
Withdrawal rate (1% movement)	362.38	(351.57)	298.05	(288.33)	246.52	(239.54)

Although the analysis does not take account of the full distribution of cash flows expected under the plan, it does provide an approximation of the sensitivity of the assumptions shown.

The expected future contribution and estimated future benefit payments from the fund areas follows:

Expected cash flows over the next (valued on undiscounted basis):	For the year ended	For the year ended	For the year ended
	31 March 2021	31 March 2020	31 March 2019
1 year	26.75	20.71	16.11
2 to 5 years	93.28	79.91	74.48
6 to 10 years	153.07	125.29	109.87
More than 10 years	472.11	424.65	401.57

g) Asset liability matching strategies

The Group has purchased insurance policy, which is basically a year-on-year cash accumulation plan in which the interest rate is declared on yearly basis and is guaranteed for a period of one year. The insurance company, as part of the policy rules, makes payment of all gratuity liability occurring during the year (subject to sufficiency of funds under the policy). The policy, thus, mitigates the liquidity risk. However, being a cash accumulation plan, the duration of assets is shorter compared to the duration of liabilities. Thus, the Group is exposed to movement in interest rate (in particular, the significant fall in interest rates, which should result in a increase in liability without corresponding increase in the asset).

h) The Group has purchased an insurance policy to provide for payment of gratuity to the employees. Every year, the insurance company carries out a funding valuation based on the latest employee data provided by the Group. Any deficit in the assets arising as a result of such valuation is funded by the Group.

Sansera Engineering Limited (formerly known as Sansera Engineering Private Limited)
Notes to the Restated Consolidated Financial Information (continued)

43 Employee stock options

The Company has a share option scheme for the permanent employees of the Company and its subsidiaries. In accordance with the terms of the plan, as approved by shareholders, permanent employees may be granted options to purchase equity shares.

Each employee share option converts into one equity share of the Company on exercise. No amounts are paid or payable by the recipient on receipt of the option. The options carry neither rights to dividends nor voting rights. Options may be exercised at any time from the date of vesting to the date of their expiry as per ESOP Schemes.

On 12 March 2015, the Board of Directors of the Company approved "Sansera Employee Stock Option Plan 2015" ("the Plan") for grant of stock options to the employees of the Group which was further ratified by the shareholders on 13 April 2015. The vested options can be exercised by the option holder and the shares can be allotted by the board in the event as specified in the Plan. The plans are as follows:

Program 1: Key management group

Options under this program are granted to certain employees at an exercise price of ₹ 0.14 per option. The entire stock options are completely vested.

The following reconciles the outstanding share options granted under employee share option plan at beginning and at the end of financial year:

Particulars	As at 31 March 2021		As at 31 March 2020		As at 31 March 2019	
	Number of Options	Weighted average exercise price (in ₹)	Number of Options	Weighted average exercise price (in ₹)	Number of Options	Weighted average exercise price (in ₹)
Outstanding at the beginning of the year	1,173,775	0.14	1,173,775	0.14	1,619	100
Share split and Bonus issue during the year (refer note 17(a)ii(a))	-	-	-	-	1,172,156	-
Granted during the year	-	-	-	-	-	-
Exercised during the year	-	-	-	-	-	-
Forfeited during the year	-	-	-	-	-	-
Lapsed during the year	-	-	-	-	-	-
Outstanding at the end of the year	1,173,775	0.14	1,173,775	0.14	1,173,775	0.14
Vested at the end of the year	1,173,775	0.14	1,173,775	0.14	1,173,775	0.14
Exercisable at the end of the year	-	-	-	-	-	-

Program 2: Certain identified employees

Options under this program are granted to certain employees at an exercise price of ₹135.2 per option. Stock options issued carries different vesting years, it ranges from 25 to 100 percent vesting of total options granted by the end of every one year from the grant date. All stock options shall be fully vested by the end of 4 years from the grant date.

The following reconciles the outstanding share options granted under employee share option plan at beginning and at end of the financial year:

Particulars	As at 31 March 2021		As at 31 March 2020		As at 31 March 2019	
	Number of Options	Weighted average exercise price (in ₹)	Number of Options	Weighted average exercise price (in ₹)	Number of Options	Weighted average exercise price (in ₹)
Outstanding at the beginning of the year	1,336,900	135.20	1,336,900	135.20	1,844	98,017
Share split and Bonus issue during the year (refer note 17(a)ii(a))	-	-	-	-	1,335,056	-
Granted during the year	-	-	-	-	-	-
Exercised during the year	-	-	-	-	-	-
Forfeited during the year	-	-	-	-	-	-
Lapsed during the year	-	-	-	-	-	-
Surrendered during the year	148,625	135.20	-	-	-	-
Outstanding at the end of the year	1,188,275	135.20	1,336,900	135.20	1,336,900	135.20
Vested at the end of the year	1,188,275	135.20	1,336,900	135.20	1,336,900	135.20
Exercisable at the end of the year	-	-	-	-	-	-

Measurement of fair values

Black-Scholes Option Pricing Model is used to value the fair value of the stock options. The fair value of the options and the inputs used in the measurement of the grant-date fair values of the equity-settled share based payment plans are as follows:

Particulars	Share option plans	
	Program 1: Key Management Group	Program 2: Certain Identified Employees
Grant date	29-Apr-15	29-Apr-15
Fair value at grant date	103.39	55.25
Share price at grant date	103.48	103.48
Exercise price	0.14	135.20
Expected volatility (weighted average volatility)	49.20%	49.20%
Expected term (in years)	6.50	6.50
Risk free interest rate	7.90%	7.90%

44 Financial instruments

Accounting classification and fair value

The following table shows the carrying amounts and fair values of financial assets and financial liabilities, including their levels in the fair value hierarchy.

Particulars	(Amount in ₹ millions)			
	Carrying amount	Fair value		
	31-March-2021	Level 1	Level 2	Level 3
Financial assets measured at fair value				
Investment in equity shares	42.51	5.58	-	36.93
Derivative contracts at fair value	38.54	-	38.54	-
	81.05	5.58	38.54	36.93
Financial assets measured at amortised cost				
Other non-current financial assets	298.63	-	-	-
Trade receivables	3,129.83	-	-	-
Cash and cash equivalents	365.00	-	-	-
Bank balances other than cash and cash equivalents above	286.42	-	-	-
Other current financial assets	184.27	-	-	-
	4,264.15	-	-	-
Financial liabilities measured at fair value				
Derivative liability	-	-	-	-
	-	-	-	-
Financial liabilities measured at amortised cost				
Non-Current borrowings	1,876.52	-	-	-
Current borrowings	2,552.32	-	-	-
Lease liabilities	921.16	-	-	-
Trade payables	2,270.46	-	-	-
Other financial liabilities	1,236.67	-	-	-
	8,857.13	-	-	-

Particulars	(Amount in ₹ millions)			
	Carrying amount	Fair value		
	31-March-2020	Level 1	Level 2	Level 3
Financial assets measured at fair value				
Investment in equity shares	40.46	3.53	-	36.93
	40.46	3.53	-	36.93
Financial assets measured at amortised cost				
Other non-current financial assets	301.91	-	-	-
Trade receivables	2,591.21	-	-	-
Cash and cash equivalents	600.08	-	-	-
Bank balances other than cash and cash equivalents above	116.36	-	-	-
Other current financial assets	236.47	-	-	-
	3,846.03	-	-	-
Financial liabilities measured at fair value				
Derivative liability	19.89	-	19.89	-
	19.89	-	19.89	-
Financial liabilities measured at amortised cost				
Non-Current borrowings	1,718.25	-	-	-
Current borrowings	3,554.12	-	-	-
Lease liabilities	885.53	-	-	-
Trade payables	1,728.95	-	-	-
Other financial liabilities	1,209.46	-	-	-
	9,096.31	-	-	-

Particulars	(Amount in ₹ millions)			
	Carrying amount	Fair value		
	31-March-2019	Level 1	Level 2	Level 3
Financial assets measured at fair value				
Investment in equity shares	5.34	5.34	-	-
Derivative asset	17.08	-	17.08	-
	22.42	5.34	17.08	-
Financial assets measured at amortised cost				
Other non-current financial assets	291.56	-	-	-
Trade receivables	2,712.43	-	-	-
Cash and cash equivalents	239.27	-	-	-
Bank balances other than cash and cash equivalents above	76.73	-	-	-
Other current financial assets	239.38	-	-	-
	3,559.37	-	-	-
Financial liabilities measured at fair value				
Derivative liability	-	-	-	-
	-	-	-	-
Financial liabilities measured at amortised cost				
Non-current borrowings	2,133.84	-	-	-
Current borrowings	3,043.08	-	-	-
Lease liabilities	892.19	-	-	-
Trade payables	1,865.64	-	-	-
Other financial liabilities	1,079.23	-	-	-
	9,013.98	-	-	-

Fair value hierarchy

Level 1 - Quoted prices (unadjusted) in active markets for identical assets or liabilities.

Level 2 - Inputs other than quoted prices included within Level 1 that are observable for the asset or liability, either directly (i.e. as prices) or indirectly (i.e. derived from prices). The derivative contracts are valued using market approach, determined using the forward exchange rates as at the balance sheet date.

Level 3 - Inputs for the assets or liabilities that are not based on observable market data (unobservable inputs).

The Group has not disclosed the fair value of financial instruments such as other non current financial assets, trade receivables, cash and cash equivalents, bank balances, other current financial assets, loans, borrowings, other non current financial liabilities, trade payables and other current financial liabilities because their carrying amounts are a reasonable approximation of fair value.

The majority of our costs and incomes are denominated in local currencies, which is not impacted by currency exchange fluctuations. Some of our contracts with our key export customers may not allow for price adjustments in the event of unfavourable currency exchange rate developments. Our global footprint exposes us to certain currency exchange risks, arising primarily from our foreign currency receivables, import of raw materials and capital goods for our operations, export of goods and our non-Indian rupee denominated borrowings. We hedge significant portion of our net foreign exchange exposure through forward contracts and non-Indian rupee denominated loans.

45 Financial risk management

The Group is exposed to the following risks arising from financial instruments:

- Credit risk
- Liquidity risk
- Market risk

(i) Risk management framework

The Company's board of directors has overall responsibility for the establishment and oversight of the Group's risk management framework. The Group's risk management policies are established to identify and analyse the risks faced by the Group, to set appropriate risk limits and controls and to monitor risks and adherence to limits. Risk management policies and systems are reviewed regularly to reflect changes in market conditions and the Group's activities. The Group, through its training and management standards and procedures, aims to develop a disciplined and constructive control environment in which all employees understand their roles and obligations.

(ii) Credit risk

Credit risk is the risk that counterparty will not meet its obligations under a financial instrument or customer contract, leading to a financial loss. The Group is exposed to credit risk from its operating activities (primarily trade receivables) and from its financing activities, including deposits with banks and others, foreign exchange transactions and other financial instruments. The carrying amount of financial assets represents the maximum credit exposure.

Trade receivables

The Group's exposure to credit risk is influenced mainly by the individual characteristics of each customer. However, management also considers the factors that may influence the credit risk of its customer base, including the default risk associated with the industry and country in which customers operate. In respect of trade receivables the Group performs credit assessment for customers on an annual basis and recognizes credit risk on the basis of lifetime expected losses.

Movement in expected credit loss allowance on trade receivables:

Particulars	(Amount in ₹ millions)		
	As at 31 March 2021	As at 31 March 2020	As at 31 March 2019
Balance as at the beginning of the year	23.61	23.61	23.11
Movement in the expected credit loss allowance on trade receivables	-	-	0.50
Balance at the end of the year	23.61	23.61	23.61

Security deposits and other Financial assets:

Expected credit loss for security deposits and Other Financial assets is as follows:

Particulars	Year ended	Assets of the Group	Estimated gross carrying amount at default	Expected probability of default	Expected credit losses	Carrying amount, net of impairment provision
Loss allowance measured at 12 month expected credit loss: Financial assets for which credit risk has not increased significantly since initial recognition	31-Mar-21	Security deposits	284.54	0%	-	284.54
		Other Financial Assets	198.36	0%	-	198.36
	31-Mar-20	Security deposits	267.10	0%	-	267.10
		Other Financial Assets	271.28	0%	-	271.28
	31-Mar-19	Security deposits	258.33	0%	-	258.33
		Other Financial Assets	272.61	0%	-	272.61

Cash and cash equivalents (including bank balances, fixed deposits and margin money with banks):

Credit risk on cash and cash equivalent is limited as the Group generally transacts with banks and others with high credit ratings assigned by international and domestic credit rating agencies.

(iii) Liquidity risk

Liquidity risk is the risk that the Group will encounter difficulty in meeting the obligations associated with its financial liabilities that are settled by delivering cash or another financial assets. The Group's approach to managing liquidity is to ensure, as far as possible, that it will have sufficient liquidity to meet its liabilities when they are due, under both normal and stressed conditions, without incurring unacceptable losses or risking damage to the Group's reputation.

The following are the remaining contractual maturities of financial liabilities at the reporting date. The amounts are gross and undiscounted:

Particulars	(Amount in ₹ millions)				
	As at 31 March 2021				
	Carrying amount	Total	Less than 1 year	1-2 years	Above 2 years
Non-current borrowings including current maturities	2,930.24	2,930.24	1,053.72	808.73	1,067.79
Current borrowings	2,552.32	2,552.32	2,552.32	-	-
Trade payables	2,270.46	2,270.46	2,270.46	-	-
Other financial liabilities	182.95	182.95	182.95	-	-
Lease liabilities	921.16	921.16	110.88	107.49	702.79

Particulars	(Amount in ₹ millions)				
	As at 31 March 2020				
	Carrying amount	Total	Less than 1 year	1-2 years	Above 2 years
Non-current borrowings including current maturities	2,813.65	2,813.65	1,095.46	755.87	962.32
Current borrowings	3,554.12	3,554.12	3,554.12	-	-
Trade payables	1,728.95	1,728.95	1,728.95	-	-
Other financial liabilities	133.95	133.95	122.91	11.04	-
Lease liabilities	885.53	885.53	96.94	99.07	689.52

Particulars	(Amount in ₹ millions)				
	As at 31 March 2019				
	Carrying amount	Total	Less than 1 year	1-2 years	Above 2 years
Non-current borrowings including current maturities	2,910.55	2,910.55	1,095.73	892.41	922.40
Current borrowings	3,043.08	3,043.08	3,043.08	-	-
Trade payables	1,865.64	1,865.64	1,865.64	-	-
Other financial liabilities	302.52	302.52	225.65	76.87	-
Lease liabilities	892.19	892.19	86.48	89.36	716.35

45 Financial risk management (continued)

(iv) Market risk

Market risk is the risk that the fair value of future cash flows of a financial instrument will fluctuate because of changes in market prices. Market prices comprises interest rate risk and currency rate risk. Financial instruments affected by market risk include loans, borrowings, receivables and payables. The Group's activities expose it to a variety of financial risks, including effects of changes in foreign currency exchange rates and interest rate movement.

(v) Interest rate risk

Interest rate risk is the risk that the fair value or future cash flows of a financial instrument will fluctuate because of change in market interest rates. The Group's exposure to risk of changes in market interest rates relates primarily to the Group's long term debt obligations with floating interest rates.

Exposure to interest rate risk

The exposure of the Group's borrowing to interest rate changes at the end of the reporting period are as follows :-

Particulars	(Amount in ₹ millions)		
	As at 31 March 2021	As at 31 March 2020	As at 31 March 2019
Fixed rate instruments:			
Financial liabilities	466.14	473.87	457.19
Variable rate instruments:			
Financial liabilities	5,016.42	5,893.90	5,496.44
Fixed rate instruments exposed to interest rate risks	5,482.56	6,367.77	5,953.63

Interest rate sensitivity:

Sensitivity analysis for fixed-rate instruments

There is no impact on the profit or loss on account of fixed rate instruments.

Cash flow sensitivity analysis for variable-rate instruments

The sensitivity analysis below have been determined based on exposure to interest rate. For floating rate liabilities, analysis is prepared assuming the amount of liability outstanding at the end of the reporting period was outstanding for the whole year. With all other variables held constant, the Group's profit before tax is affected through the impact on floating rate borrowings, as follows:

Particulars	Currency	Effect on profit before tax		
		31-March-2021	31-March-2020	31-March-2019
Increase of 100 basis points	INR	50.16	58.94	54.96
Decrease in 100 basis points	INR	(50.16)	(58.94)	(54.96)

(vi) Foreign currency risk

The Group is exposed to currency risk on certain transactions that are denominated in a currency other than the Group's functional currency, hence exposures to exchange rate fluctuations arise. The risk is that the functional currency value of cash flows will vary as a result of movements in exchange rates. The Group uses forward exchange contracts to hedge its currency risk, most with a maturity of less than one year from the reporting date.

Foreign currency (FC) risk is the risk that the fair value or future cash flows of an exposure will fluctuate because of changes in foreign exchange rates. The Group evaluates the impact of foreign exchange rate fluctuations by assessing its exposure to exchange rate risks. It hedges a part of these risks by using derivative financial instruments. The information on derivative instruments is as follows.

Particulars	Currency	As at 31 March 2021		As at 31 March 2020		As at 31 March 2019	
		Amount in foreign currency in millions	Amount in ₹ millions	Amount in foreign currency in millions	Amount in ₹ millions	Amount in foreign currency in millions	Amount in ₹ millions
Forward contract (to hedge net receivables)	USD	12.36	903.27	10.13	766.11	2.38	164.24
No. of Contracts		20	-	30	-	19	-
Forward contract (to hedge net receivables)	EUR	8.75	750.31	7.23	598.01	2.63	203.89
No. of Contracts		11	-	27	-	21	-
Forward contract (to hedge net receivables)	EUR/USD	1.80	154.35	-	-	-	-
No. of Contracts		3	-	-	-	-	-
Forward contract (to hedge borrowing)	USD	7.69	561.99	-	-	-	-
No. of Contracts		6	-	-	-	-	-
Forward contract (to hedge borrowing)	EUR/USD	1.00	85.75	-	-	-	-
No. of Contracts		2	-	-	-	-	-

The Group's exposure to the risk of changes in foreign exchange rates relates primarily to its operating activities when revenue and expense is denominated in a foreign currency.

The following table presents foreign currency risk from financial instruments as of:

Particulars	Currency	As at 31 March 2021		As at 31 March 2020		As at 31 March 2019	
		Amount in foreign currency in millions	Amount in ₹ millions	Amount in foreign currency in millions	Amount in ₹ millions	Amount in foreign currency in millions	Amount in ₹ millions
Trade receivables	USD	11.63	850.51	10.07	761.60	8.69	600.85
	EUR	9.54	817.96	7.07	585.05	10.84	841.92
Cash and cash equivalents	USD	0.22	15.91	0.56	42.68	0.61	41.94
	EUR	0.42	35.89	1.17	97.19	1.32	102.37
Trade payables	USD	0.38	27.97	0.23	17.22	(0.64)	(44.12)
	EUR	1.95	167.22	0.48	39.97	(2.04)	(158.83)
	JPY	39.31	25.99	7.77	5.41	(47.69)	(29.77)
	GBP	0.16	16.42	0.01	0.68	(0.18)	(8.95)
	SGD	-	-	0.16	8.64	0.00	0.00
Borrowings	USD	3.76	275.03	8.56	647.37	10.86	750.95
	EUR	0.18	15.01	2.15	178.08	9.36	727.36

45 Financial risk management (continued)

(vi) Foreign currency risk (continued)

Particulars	Percentage movement	(Amount in ₹ millions)			
		Effect on profit before tax		Effect on equity	
		Strengthening	Weakening	Strengthening	Weakening
31 March-2021					
USD	3%	16.90	(16.90)	12.65	(12.65)
EURO	3%	20.15	(20.15)	15.08	(15.08)
JPY	5%	(1.30)	1.30	(0.97)	0.97
GBP	7%	(1.15)	1.15	(0.86)	0.86
SGD	2%	-	-	-	-
31 March-2020					
USD	2%	2.79	(2.79)	2.09	(2.09)
EURO	2%	9.28	(9.28)	6.94	(6.94)
JPY	4%	(0.22)	0.22	(0.16)	0.16
GBP	2%	(0.01)	0.01	(0.01)	0.01
SGD	0%	-	-	-	-
31 March-2019					
USD	8%	(5.06)	5.06	(3.31)	3.31
EURO	7%	24.82	(24.82)	16.23	(16.23)
JPY	8%	2.41	(2.41)	1.58	(1.58)
GBP	6%	0.57	(0.57)	0.37	(0.37)
SGD	8%	-	-	-	-

46 Capital management

The Group's policy is to maintain a strong capital base so as to maintain investor, creditor and market confidence and to sustain future development of the business. The Board of Directors monitors the return on capital employed.

The Group manages capital risk by maintaining sound/optimal capital structure through monitoring of financial ratios, such as debt-to-equity ratio and net borrowings-to-equity ratio and implements capital structure improvement plan when necessary.

The Group uses debt ratio as a capital management index and calculates the ratio as net debt divided by total equity. Net debt and total equity are based on the amounts stated in the restated consolidated financial information.

Particulars	(Amount in ₹ millions)		
	As at	As at	As at
	31 March 2021	31 March 2020	31 March 2019
Gross debt*	5,497.49	6,367.77	5,953.63
Less : Cash and cash equivalent and other bank balances	651.42	716.44	316.00
Net debt (A)	4,846.07	5,651.33	5,637.63
Total equity** (B)	8,887.41	7,768.56	6,945.18
Net debt to equity ratio (A / B)	0.55	0.73	0.81

* Gross debt includes non-current borrowings, current borrowings, current maturities of non-current borrowings and accrued interest.

** Total equity includes equity share capital, instruments entirely equity in nature, non-controlling interests and other equity.

(Amount in ₹ millions)

47 Dues to micro and small enterprises

The Ministry of Micro, Small and Medium Enterprises has issued an office memorandum dated 26 August 2008 which recommends that the Micro and Small Enterprises should mention in their correspondence with its customers the Entrepreneurs Memorandum Number as allocated after filing of the Memorandum in accordance with the 'Micro, Small and Medium Enterprises Development Act, 2006' ('the Act'). Accordingly, the disclosure in respect of the amounts payable to such enterprises as at ₹ 111.39 million (31 March 2020: ₹ 75.83 million ; 31 March 2019: ₹ 100.01 million) has been made in the restated consolidated financial information based on information received and available with the Group. Further in view of the Management, the impact of interest, if any, that may be payable in accordance with the provisions of the Act is not expected to be material. The Group has not received any claim for interest from any supplier as at the reporting date.

Particulars	As at 31 March 2021	As at 31 March 2020	As at 31 March 2019
The principal amount and the interest due thereon remaining unpaid to any supplier as at the end of each accounting year: *			
– Principal	110.05	75.00	99.73
– Interest	1.34	0.83	0.28
The amount of interest paid by the buyer in terms of Section 16 of the Micro, Small and Medium Enterprises Development Act, 2006, (the Act) along with the amount of the payment made to the supplier beyond the appointed day during each accounting year	-	-	-
The amount of interest due and payable for the period of delay in making payment (which have been paid but beyond the appointed day during the year) but without adding interest specified under the said Act	-	-	-
The amount of interest accrued and remaining unpaid at the end of each year	1.34	0.83	0.28
The amount of further interest remaining due and payable even in the succeeding years, until such date when the interest dues as above are actually paid to the small enterprise.	1.34	0.83	0.28

* Includes amount payable to capital creditors amounting to ₹ 25.00 million (31 March 2020: ₹ 8.60 million ; 31 March 2019 ₹ 8.84 million)

48 Expenditure on corporate social responsibility

As per Section 135 of the Companies Act, 2013, a Group, meeting the applicability threshold, needs to spend at least 2% of its average net profit for the immediately preceding three financial years on corporate social responsibility (CSR) activities. A CSR committee has been formed by the Group as per the Act. The funds are allocated to the activities which are specified in Schedule VII of the Companies Act, 2013.

Particulars	(Amount in ₹ millions)		
	For the year ended 31 March 2021	For the year ended 31 March 2020	For the year ended 31 March 2019
(a) Gross amount required to be spent by the Group during the year	29.53	29.81	23.79
(b) Amount spent during the year on:			
i) Construction/acquisition of any asset	0.31	6.22	-
ii) On purpose other than (i) above	20.42	23.78	14.38
	20.73	30.00	14.38
(c) Amount unspent during current financial year	8.80	NA	NA

49 Cash flow disclosures

(Amount in ₹ millions)

Reconciliation between opening and closing balances in the Restated consolidated statement of assets and liabilities for liabilities and financial assets arising from financing activities:

Particulars	Opening balance	Cash flows		Non-cash movements	Closing balance
	1 April 2020	Proceeds	Repayments	Fair value changes	31 March 2021
Non-current borrowings	2,813.65	1,099.93	(979.92)	(3.42)	2,930.24
Current borrowings*	3,554.12	-	(992.26)	(9.54)	2,552.32
Total liabilities from financing activities	6,367.77	1,099.93	(1,972.18)	(12.96)	5,482.56

Reconciliation between opening and closing balances in the Restated consolidated statement of assets and liabilities for liabilities and financial assets arising from financing activities:

Particulars	Opening balance	Cash flows		Non-cash movements	Closing balance
	1 April 2019	Proceeds	Repayments	Fair value changes	31 March 2020
Non-current borrowings	2,910.55	809.50	(951.69)	45.29	2,813.65
Current borrowings*	3,043.08	490.64	-	20.40	3,554.12
Total liabilities from financing activities	5,953.63	1,300.14	(951.69)	65.69	6,367.77

* Current borrowings are disclosed net of repayments/proceeds.

50 Segment reporting

Information reported to the chief operating decision maker (CODM) for the purposes of resource allocation and assessment of segment performance focuses on the types of goods or services delivered or provided. The Group is in the business of manufacture and sale of automobile components, which in the context of Indian Accounting Standard 108 'Segment Information' represents single reportable business segment. The entire operations are governed by the same set of risk and returns. Accordingly, these operations represent a single segment. The revenues, total expenses and net profit as per the restated consolidated statement of profit and loss represents the revenue, total expenses and the net profit of the sole reportable segment.

(i) Geographical information

Geographic segmentation is based on business sourced from specific geographic regions. Other foreign countries comprises all other places except India, Europe and USA.

(Amount in ₹ millions)

Particulars	(a) Revenue from operations		
	For the year ended 31 March 2021	For the year ended 31 March 2020	For the year ended 31 March 2019
India	10,173.04	10,253.33	11,430.36
Europe	3,753.41	3,308.47	3,734.19
USA	1,102.69	720.42	930.98
Other foreign countries	463.57	289.48	148.77
Total	15,492.71	14,571.70	16,244.30

Sansera Engineering Limited (formerly known as Sansera Engineering Private Limited)
Notes to the Restated Consolidated Financial Information (continued)

50 Segment reporting (continued)

(Amount in ₹ millions)

Particulars	As at	As at	As at
	31 March 2021	31 March 2020	31 March 2019
(b) Non-current assets			
India	10,815.83	10,373.42	9,961.70
Other foreign countries	1,283.04	1,158.25	1,222.12
	12,098.87	11,531.67	11,183.82
Reconciling items:			
Income tax assets	27.14	29.30	62.48
Other non-current financial assets	335.56	338.84	291.56
Total non current assets	12,461.57	11,899.81	11,537.86

51 Impairment

For the purpose of impairment testing, goodwill acquired in a business combination is allocated to the cash generating units (CGU) or groups of CGU's, which benefit from the synergies of the acquisition. The chief operating decision maker reviews the goodwill for any impairment at each entity level, which is represented as separated CGU's.

The carrying value of goodwill, entity wise is as follows:

(Amount in ₹ millions)

Entity acquired	As at	As at	As at
	31 March 2021	31 March 2020	31 March 2019
Fitwel Tools and Forgings Private Limited ('Fitwel')	146.72	146.72	146.72
Sansera Sweden AB ('Sansera Sweden')	176.92	177.49	196.24
Exchange differences on translation of foreign operations	34.73	(0.57)	(18.75)
Total carrying value	358.37	323.64	324.21

The recoverable amount of a cash-generating unit is the higher of its fair value less costs of disposal and its value in use. For the purpose of impairment test, fair value of a CGU is determined based on the market capitalization and the value in use is determined based on specific calculations. The recoverable amount of all CGU's has been determined based on value in use calculations. These calculations use pre-tax cash flow projections based on financial budgets approved by management covering a five-year period and an average of the range of each assumption mentioned below:

Particulars	As at 31 March 2021		As at 31 March 2020		As at 31 March 2019	
	Fitwel	Sansera Sweden	Fitwel	Sansera Sweden	Fitwel	Sansera Sweden
Discount rate*	14.90%	12.00%	14.90%	12.00%	15.57%	13.00%
Terminal growth rate **	4%	2%	4%	2%	5%	2%
Operating margins	9% - 16%	4% - 13%	9% - 16%	4% - 13%	9% - 12%	36% - 43%

*These discount rate(s) are based on the Weighted Average Cost of Capital (WACC) of the Company. These estimates are likely to differ from future actual results of operations and cash flows.

** The cash flow projections include specific estimates for five years and a terminal growth rate thereafter. The terminal growth rate has been determined based on management's estimates of the long-term compound annual EBITDA growth rate, consistent with the assumptions that a market participant would make.

The Group does its impairment evaluation on an annual basis and as of March 31, 2021, the estimated recoverable amount of the CGU exceeded its carrying amount, hence impairment is not triggered. The Group has performed sensitivity analysis for all key assumptions, including the cash flow projections, consequent to the change in estimated future economic conditions arising from the possible effects due to COVID-19 and is unlikely to cause the carrying amount of the CGU exceed its estimated recoverable amount.

As of 31 March 2021, the estimated recoverable amount of each of the CGU's exceeded its carrying amount by ₹ 571.71(31 March 2020 ₹ 523.07; 31 March 2019 ₹ 22.57) (Fitwel Tools and Forgings Private Limited) ₹ 953.85 million (31 March 2020 ₹ 855.55; 31 March 2019 ₹ 66.18) (Sansera Sweden AB) and hence impairment is not triggered. The carrying amount of the CGU was computed by allocating the net assets to operating segments for the purpose of impairment testing.

52 Additional Information pursuant to paragraph 2 of division II of Schedule III to Companies Act, 2013 'General Instruction for preparation of restated consolidated financial Statements

Name of the Entity	(Amount in ₹ millions)							
	As at/for the year ended 31 March 2021							
	Net Assets		Share in profit/(loss)		Share in other comprehensive		Share in Total Comprehensive Income	
As % of consolidated net assets	Amount	As % of consolidated loss	Amount	As % of consolidated (OCI)	Amount	As % of consolidated total comprehensive loss	Amount	
Parent								
Sansera Engineering Limited	99.85%	8,874.37	89.10%	978.80	(86.81)%	(17.58)	85.91%	961.22
Subsidiary								
Sansera Sweden AB	0.95%	84.85	5.12%	56.20	-	-	5.02%	56.20
Sansera Engineering Pvt Ltd, Mauritius	10.28%	913.42	0.43%	4.75	-	-	0.42%	4.75
Fitwel Tools and Forgings Private Limited	3.95%	350.80	5.69%	62.48	(8.74)%	(1.77)	5.43%	60.71
Non-controlling interest	1.18%	104.99	1.71%	18.74	(2.62)%	(0.53)	1.63%	18.21
Elimination on account of Consolidation	(16.21)%	(1,441.02)	(2.04)%	(22.37)	198.17%	40.13	1.59%	17.76
Consolidated net assets/loss after tax	100.00%	8,887.41	100.00%	1,098.60	100.00%	20.25	100.00%	1,118.85

Name of the Entity	(Amount in ₹ millions)							
	As at/for the year ended 31 March 2020							
	Net Assets		Share in profit/(loss)		Share in other comprehensive income (OCI)		Share in Total Comprehensive Income	
As % of consolidated net assets	Amount	As % of consolidated loss	Amount	As % of consolidated (OCI)	Amount	As % of consolidated total comprehensive loss	Amount	
Parent								
Sansera Engineering Limited	101.86%	7,913.16	102.43%	818.44	(32.93)%	(8.01)	98.43%	810.43
Subsidiary								
Sansera Sweden AB	(0.09)%	(7.31)	(1.31)%	(10.49)	0.00%	0.00	(1.27)%	(10.49)
Sansera Engineering Pvt Ltd, Mauritius	12.09%	938.90	1.03%	8.21	0.00%	0.00	1.00%	8.21
Fitwel Tools and Forgings Private Limited	3.73%	290.10	(1.69)%	(13.50)	(7.32)%	(1.78)	(1.86)%	(15.28)
Non-controlling interest	1.12%	86.78	(0.51)%	(4.05)	(2.20)%	(0.53)	(0.56)%	(4.58)
Elimination on account of Consolidation	(18.70)%	(1,453.07)	0.06%	0.44	142.44%	34.65	4.26%	35.09
Consolidated net assets/loss after tax	100.00%	7,768.56	100.00%	799.05	100.00%	24.33	100.00%	823.37

Name of the Entity	(Amount in ₹ millions)							
	As at/for the year ended 31 March 2019							
	Net Assets		Share in profit/(loss)		Share in other comprehensive income (OCI)		Share in Total Comprehensive Income	
As % of consolidated net assets	Amount	As % of consolidated loss	Amount	As % of consolidated (OCI)	Amount	As % of consolidated total comprehensive loss	Amount	
Parent								
Sansera Engineering Limited	102.27%	7,102.73	113.92%	1,117.10	5.09%	(1.72)	117.80%	1,115.38
Subsidiary								
Sansera Sweden AB	(0.02)%	(1.16)	(20.33)%	(199.39)	0.00%	0.00	(21.06)%	(199.39)
Sansera Engineering Pvt Ltd, Mauritius	12.53%	870.27	0.66%	6.43	0.00%	0.00	0.68%	6.43
Fitwel Tools and Forgings Private Limited	4.40%	305.38	6.30%	61.78	0.91%	(0.31)	6.49%	61.47
Non-controlling interest	1.31%	91.36	1.89%	18.51	0.20%	(0.07)	1.95%	18.45
Elimination on account of Consolidation	(20.49)%	(1,423.40)	(2.43)%	(23.79)	93.80%	(31.68)	(5.86)%	(55.47)
Consolidated net assets/loss after tax	100.00%	6,945.18	100.00%	980.64	100.00%	(33.78)	100.00%	946.86

Interest in other entities

Subsidiary companies:

The restated consolidated financial information of the Group includes subsidiary companies listed in the table below:

Name of the entity	Country of incorporation	Ownership interest held	
		Ownership interest held by the Group (%)	Ownership interest held by non-controlling interest (%)
		31 March 2021	31 March 2021
Sansera Sweden AB	Sweden	100%	-
Sansera Engineering Pvt Ltd, Mauritius	Mauritius	100%	-
Fitwel Tools and Forgings Private Limited	India	70%	30%

Name of the entity	Country of incorporation	Ownership interest held	
		Ownership interest held by the Group (%)	Ownership interest held by non-controlling interest (%)
		31 March 2020	31 March 2020
Sansera Sweden AB	Sweden	100%	-
Sansera Engineering Pvt Ltd, Mauritius	Mauritius	100%	-
Fitwel Tools and Forgings Private Limited	India	70%	30%

Name of the entity	Country of incorporation	Ownership interest held	
		Ownership interest held by the Group (%)	Ownership interest held by non-controlling interest (%)
		31 March 2019	31 March 2019
Sansera Sweden AB	Sweden	100%	-
Sansera Engineering Pvt Ltd, Mauritius	Mauritius	100%	-
Fitwel Tools and Forgings Private Limited	India	70%	30%

- 53 World Health Organization (WHO) declared outbreak of Coronavirus Disease (COVID-19) a global pandemic on March 11, 2020. Consequent to this, the Government of India declared lockdown on March 23, 2020 and the Group temporarily suspended the operations in its manufacturing facilities in India in compliance with the lockdown instructions issued by the Central and State Governments. COVID-19 has impacted the normal business operations of the Group by way of interruption in production, supply chain disruption, unavailability of personnel, closure/lock down of production facilities etc. during the lock-down period, which was extended till mid May 2020.

After resuming operations, the demand in the served markets has recovered sharply and coupled with the Group's product expansion initiatives, the Group was able to register net revenue growth despite a degrowth in the automotive sector. With current visibility of additional business from new customers / products, the Group should continue to outperform the broader industry.

As of 31 March 2021, the Group's balance sheet has been strengthened, with reduction in borrowings against the year ended 31 March 2020. The Group has also generated sequentially higher operating cash flows during the year ended 31st March 2021 and expects to continue the same in future years. The management believes the Group will be able to continue to generate sufficient cash flows and its ability to use unutilised bank limits will help meet its obligations as and when these fall due.

Furthermore, the Group's Management believes that, it has taken into account all the possible impacts of known events arising from COVID-19 pandemic and the resultant lockdowns in the preparation of the financial statements including but not limited to its assessment of Group's liquidity and going concern, recoverable values of its property, plant and equipment, intangible assets, investments, goodwill, inventory and the net realisable values of other assets. However, given the effect of these lockdowns on the overall economic activity and in particular on the automobile industry, the impact assessment of COVID-19 on the abovementioned financial statement captions is subject to significant estimation uncertainties given its nature and duration and, accordingly, the actual impacts in future may be different from those estimated as at the date of approval of these restated consolidated financial statements. The Group will continue to monitor any material changes to future economic conditions and consequential impact on its restated consolidated financial statements.

- 54 The new Code on Social Security, 2020 (the Code) has been enacted, which would impact the contributions by the Group towards Provident Fund and Gratuity. The effective date from which the changes are applicable is yet to be notified. The Ministry of Labour and Employment (Ministry) has released draft rules for the Code on November 13, 2020 and has invited suggestions from stake holders, which are under active consideration by the Ministry. The Group will complete its evaluation and will give appropriate impact in its financial statements in the period in which, the Code becomes effective and the related rules are published.

Statement of Adjustments to the Restated Consolidated Statement

55 Summarised below are the restatement adjustments made to the equity of the Audited consolidated Financial Statements for years ended 31 March 2021, 31 March 2020 and 31 March 2019 and their consequential impact on the equity:

		(Amount in ₹ millions)		
		As at		
	Note	31 March 2021	31 March 2020	31 March 2019
A	Total Equity as per Audited consolidated Financial Statements	8,887.41	7,768.56	6,974.00
B	Adjustments:			
	Material restatement Adjustments:			
	(i) Audit qualifications			
		-	-	-
	(ii) Adjustments due to prior period items / other adjustments			
	Adjustments on account of adoption of Ind AS 116	-	-	(40.14)
	Total	-	-	(40.14)
	(iii) Deferred tax impact on adjustments in (i) and (ii), as applicable			
	Deferred tax impact on restatement adjustments	-	-	11.32
	Total	-	-	11.32
C	Total impact of adjustments (i + ii + iii)	-	-	(28.82)
	As adjusted to total equity as at 1 April 2018			(16.32)
	As adjusted to statement of profit and loss for the year (Refer note below)			(12.49)
D	Total equity as per Restated consolidated Statement (A+C)	8,887.41	7,768.56	6,945.18

Summarised below are the restatement adjustments made to the profit after tax of the Audited consolidated Financial Statements for the years ended 31 March 2021, 31 March 2020 and 31 March 2019 and their consequential impact on the profit/ (loss):

		(Amount in ₹ millions)		
		As at		
	Note	31 March 2021	31 March 2020	31 March 2019
A	Total Profit after tax as per Audited consolidated Financial Statements	1,098.60	802.35	993.13
B	Adjustments:			
	Material restatement Adjustments:			
	(i) Audit qualifications			
	Total	-	-	-
	(ii) Adjustments due to prior period items / change in accounting policies			
	Adjustments on account of adoption of Ind AS 116	-	-	(15.05)
	Total	-	-	(15.05)
	(iii) Deferred tax impact on adjustments in (i) and (ii), as applicable			
	Deferred tax impact on restatement adjustments	-	(3.30)	2.56
	Total	-	(3.30)	2.56
C	Total impact of adjustments (i + ii + iii)	-	(3.30)	(12.49)
D	Profit after tax as per Restated Consolidated Financial Information (A+C)	1,098.60	799.05	980.64

Note:

1. There are no audit qualification in auditor's report for the financial years ended 31 March 2021, 31 March 2020 and 31 March 2019.

2. **Material restatement adjustments:**

(a) **Recognition of Right-of-use assets and lease liability:**

A new lease standard i.e., Ind AS 116 has been notified to be effective w.e.f. 1 April 2019 which provides guidelines for the accounting of the lease contracts entered in the capacity of a lessee and a lessor. For the purpose of preparation of Restated consolidated Summary Statement, the management has evaluated the impact of change in accounting policies on adoption of Ind AS 116 for the year ended 31 March 2019. Hence in these Restated consolidated Summary Statement, Ind AS 116 has been adopted with effect from 01 April 2018 following modified retrospective method (i.e. on 01 April 2018 the Group has measured the lease liability at the present value of the lease payments, discounted using the lessee's incremental borrowing rate and a right-of-use asset were recognised based on the carrying amount as if the standard had always been applied). Impact of adoption of Ind AS 116 has been adjusted in the respective years for the purpose of restatement.

(b) **Deferred tax assets (net):**

Deferred tax has been computed on adjustments made as detailed above and has been adjusted in the Restated consolidated statement.

3. **Material re-groupings:**

Appropriate re-groupings have been made in the Restated Consolidated financial information, wherever required, by reclassification of the corresponding items of income, expenses, assets, liabilities and cash flows, in order to bring them in line with the accounting policies and classification as per the Ind AS financial information of the Group for the year ended 31 March 2021 prepared in accordance with Schedule III of Companies Act, 2013, requirements of Ind AS 1 and other applicable Ind AS principles and the requirements of the Securities and Exchange Board of India (Issue of Capital & Disclosure Requirements) Regulations, 2018, as amended.

Sansera Engineering Limited (formerly known as Sansera Engineering Private Limited)
Notes to the Restated Consolidated Financial Information (continued)

56 Transactions within the Group: (these transactions got eliminated in restated Consolidated financial information)*

Particulars	(Amount in ₹ millions)		
	As at		
	31 March 2021	31 March 2020	31 March 2019
Transactions by the Company with other Group entities:			
1 Purchase of raw material			
Fitwel Tools and Forgings Private Limited	2.05	2.45	5.06
2 Sale of raw materials			
Fitwel Tools and Forgings Private Limited	3.66	4.44	4.63
Sansera Sweden AB	4.50	6.12	-
3 Purchase of products			
Fitwel Tools and Forgings Private Limited	485.43	467.53	588.99
4 Purchase of services			
Fitwel Tools and Forgings Private Limited	-	-	15.01
5 Sale of property, plant and equipments			
Fitwel Tools and Forgings Private Limited	6.72	-	-
6 Investment in Preference shares			
Sansera Engineering Pvt. Ltd. Mauritius	-	117.04	271.84
7 Redemption of Preference shares			
Sansera Engineering Pvt. Ltd. Mauritius	162.42	79.60	-
8 Sale of tools			
Sansera Sweden AB	10.05	-	-
9 Bank charges reimbursement			
Sansera Sweden AB	2.46	-	-
In the Books of Fitwel Tools and Forgings Private Limited:			
1 Service income			
Sansera Engineering Limited	-	-	15.01
2 Sale of products			
Sansera Engineering Limited	485.43	467.53	588.99
3 Purchase of Products			
Sansera Engineering Limited	-	-	4.63
4 Purchase of raw materials			
Sansera Engineering Limited	3.66	4.44	-
5 Sale of raw materials			
Sansera Engineering Limited	2.05	2.45	5.06
6 Purchase of property, plant and equipments			
Fitwel Tools and Forgings Private Limited	6.72	-	-
In the Books of Sansera Engineering Pvt. Ltd. Mauritius:			
1 Interest income on loans given			
Sansera Sweden AB	5.93	10.08	8.55
2 Loan given to			
Sansera Sweden AB	-	123.40	271.85
3 Loan repaid by			
Sansera Sweden AB	196.57	78.85	-
4 Receipt of Preference share capital			
Sansera Engineering Limited	-	117.04	271.84
5 Redemption of Preference share capital			
Sansera Engineering Limited	162.42	79.60	-

Sansera Engineering Limited (formerly known as Sansera Engineering Private Limited)
Notes to the Restated Consolidated Financial Information (continued)

Particulars	(Amount in ₹ millions)		
	As at		
	31 March 2021	31 March 2020	31 March 2019
In the Books of Sansera Sweden AB :			
1 Purchase of raw materials			
Sansera Engineering Limited	4.50	6.12	-
2 Purchase of tools			
Sansera Engineering Limited	10.05	-	-
3 Bank charges reimbursement			
Sansera Engineering Limited	2.46	-	-
4 Interest expenses on loans taken			
Sansera Engineering Pvt. Ltd. Mauritius	5.93	10.08	8.55
5 Loan received from			
Sansera Engineering Pvt. Ltd. Mauritius	-	123.40	271.85
6 Loan repaid to			
Sansera Engineering Pvt. Ltd. Mauritius	196.57	78.85	-
The balances receivables from and payable within the Group: (these transactions got eliminated in restated Consolidated financial information)*			
In the Books of the Company:			
1 Trade payable			
Fitwel Tools and Forgings Private Limited	13.62	74.96	118.41
2 Advance			
Fitwel Tools and Forgings Private Limited	-	6.81	-
3 Trade receivable			
Sansera Sweden AB	2.67	3.20	-
Fitwel Tools and Forgings Private Limited	-	0.06	-
In the Books of Fitwel Tools and Forgings Private Limited:			
1 Trade receivable			
Sansera Engineering Limited	13.62	74.96	118.41
2 Advance			
Sansera Engineering Limited	-	6.81	-
3 Trade payables			
Sansera Engineering Limited	-	0.06	-
In the Books of Sansera Engineering Pvt. Ltd. Mauritius:			
1 Loan receivable**			
Sansera Sweden AB	135.75	343.71	279.08
2 Interest receivable			
Sansera Sweden AB	5.86	11.73	-
In the Books of Sansera Sweden AB :			
1 Loan payable**			
Sansera Engineering Pvt. Ltd. Mauritius:	135.75	343.71	279.08
2 Interest payable			
Sansera Engineering Pvt. Ltd. Mauritius:	5.86	11.73	-
3 Trade payable			
Sansera Engineering Limited	2.67	3.20	-

* As per Schedule VI (Para 11(D)(A)(i)(g)) of ICDR Regulations

** It represents loan provided to Sansera Sweden AB by Sansera Engineering Pvt. Ltd. Mauritius bearing an annual interest rate of 3% repayable on demand.

57. Details of security, repayment terms and interest rate for non-current and current borrowings:

Repayment and interest terms	Nature of Security	Interest rate p.a *	As at 31 March 2021	As at 31 March 2020	As at 31 March 2019
I. Term loan from banks					
(i) Citi Bank					
Repayable in 20 equal quarterly instalments of ₹25.31 million per quarter starting from October 2015 and to be settled by July 2020.	Secured against all Property, plant and equipment of the company.	9.85%	-	51.13	153.13
Repayable in 20 equal quarterly instalments of ₹20.00 million per quarter starting from August 2017 and to be settled by August 2022.	Secured against all Property, plant and equipment of the company.	2.00%	137.64	237.42	303.79
(ii) HSBC Bank					
Repayable in 20 equal quarterly instalments of ₹11.111 million per quarter starting from April 2017 and to be settled by July 2022.	Secured against all Property, plant and equipment of the company.	8.15% - 8.90%	63.90	108.36	152.78
Repayable in 18 equal quarterly instalments of ₹13.89 million per quarter starting from September 2017 and to be settled by November 2022.	Secured against all Property, plant and equipment of the company.	7.90% - 9.15%	91.68	147.26	202.78
Repayable in 18 equal quarterly instalments of ₹13.89 million per quarter starting from January 2019 and to be settled by July 2023.	Secured against all Property, plant and equipment of the company.	8.05% - 8.90%	130.59	186.16	241.67
(iii) HDFC Bank					
Repayable in 20 equal quarterly instalments of ₹12.50 million per quarter starting from April 2016 and to be settled by May 2021.	Secured against all Property, plant and equipment of the company.	8.15% - 10.09%	12.26	61.78	111.29
Repayable in 20 equal quarterly instalments of ₹12.50 million per quarter starting from June 2017 and to be settled by March 2022.	Secured against all Property, plant and equipment of the company.	7.30% - 8.80%	50.00	100.76	151.18
Repayable in 20 equal quarterly instalments of ₹21 million per quarter starting from March 2019 and to be settled by August 2023.	Secured against all Property, plant and equipment of the company.	7.35% - 8.75%	210.00	296.05	380.80
Repayable in 20 equal quarterly instalments of ₹20 million per quarter starting from September 2019 and to be settled by June 2024.	Secured against all Property, plant and equipment of the company.	7.45% - 8.90%	260.00	342.42	403.02
Repayable in 20 equal quarterly instalments of ₹25 million per quarter starting from January 2021 and to be settled by October 2025.	Secured against all Property, plant and equipment of the company.	8.35%	475.00	-	-
Repayable in 60 monthly instalments of ₹ 0.33 million per month starting from 9th July 2014 and to be settled by September 2019.	Secured against all Property, plant and equipment of the company.	8.55% - 9.25%	-	-	2.00
Repayable in 60 monthly instalments of ₹ 0.17 million per month starting from 9th July 2014 and to be settled by September 2019.	Secured against all Property, plant and equipment of the company.	8.55% - 9.25%	-	-	1.02
Repayable in 60 monthly instalments of ₹ 0.34 million per month starting from 9th July 2014 and to be settled by September 2019.	Secured against all Property, plant and equipment of the company.	8.55% - 9.25%	-	-	2.07
Repayable in 57 monthly instalments of ₹ 0.33 million per month starting from August 2015 and to be settled by May 2020.	Secured against all Property, plant and equipment of the company.	8.55% - 9.25%	-	0.67	4.67
Repayable in 57 monthly instalments of ₹ 0.18 million per month starting from August 2015 and to be settled by May 2020.	Secured against all Property, plant and equipment of the company.	8.55% - 9.25%	-	0.36	2.55
Repayable in 57 monthly instalments of ₹ 0.18 million per month starting from August 2015 and to be settled by May 2020.	Secured against all Property, plant and equipment of the company.	8.55% - 9.25%	-	0.36	2.55
Repayable in 57 monthly instalments of ₹ 0.18 million per month starting from August 2015 and to be settled by May 2020.	Secured against all Property, plant and equipment of the company.	8.55% - 9.25%	-	0.36	2.46
Repayable in 60 monthly instalments of ₹ 0.37 million per month starting from June 2016 and to be settled by February 2022.	Secured against all Property, plant and equipment of the company.	7.70% - 9.25%	3.70	5.93	10.37
Repayable in 60 monthly instalments of ₹ 0.46 million per month starting from June 2016 and to be settled by January 2022.	Secured against all Property, plant and equipment of the company.	7.70% - 9.25%	4.63	7.41	12.96
Repayable in 57 monthly instalments of ₹ 0.46 million per month starting from August 2015 and to be settled by October 2022.	Secured against all Property, plant and equipment of the company.	7.70% - 9.25%	8.80	11.57	17.13
Repayable in 60 monthly instalments of Rs 0.17 million per month starting from June 2019 and to be settled by January 2024.	Secured against all Property, plant and equipment of the company.	8.25% - 9.25%	14.82	17.04	10.00
Repayable in 60 monthly instalments of ₹ 0.46 million per month starting from November 2021 and to be settled by October 2024.	Secured against all Property, plant and equipment of the company.	8.25%	51.20	-	-

57. Details of security, repayment terms and interest rate for non-current and current borrowings:

Repayment and interest terms	Nature of Security	Interest rate p.a *	As at 31 March 2021	As at 31 March 2020	As at 31 March 2019
(iv) DBS Bank					
Repayable in a bullet payment of ₹122.92 million in October 2021 and in a bullet repayment of ₹14.48 million in March 22	Secured against all Property, plant and equipment of the company.	1.72% - 4.13%	137.39	142.19	116.27
Repayable in a bullet payment of ₹15.01 million in March 2022.	Secured against all Property, plant and equipment of the company.	1.50%	15.01	178.08	114.97
(v) Axis Bank					
Repayable in 16 equal monthly installments of ₹34.87 million starting from October 2021 and to be settled by July 2025.	Secured against all Property, plant and equipment of the company.	7.35%	557.91	-	-
2. Term loan from others					
(i) Citi Financial Corporation Ltd					
Repayable in 20 equal quarterly installments of ₹20.00 million per quarter starting from July 2018 and to be settled by April 2024.	Secured against all Property, plant and equipment of the company.	9.00%	260.00	342.68	-
(ii) Bajaj Finance Limited					
Repayable in 60 equal monthly instalments of ₹3.33 million starting from August 2014 and to be settled by July 2019.	Secured against first pari passu charge on tangible assets.	9.50% - 11.05%	-	-	37.25
Repayable in 50 equal monthly instalments of ₹3.78 million starting from September 2017 and to be settled by August 2021	Secured against first pari passu charge on tangible assets.	8.00% - 10.20%	19.16	61.02	98.60
Repayable in 54 equal monthly instalments of ₹6.72 million starting from April 2019 and to be settled by September 2023	Secured against all Property, plant and equipment of the company.	8.00% - 9.50%	182.17	245.93	302.42
Repayable in 48 equal monthly instalments of ₹4.88 million starting from February 2021 and to be settled by January 2025.	Secured against all Property, plant and equipment of the company.	8.00% - 8.85%	192.86	201.50	-
(ii) Fitwel Tools and Forgings Private Limited (Subsidiary Company)					
Term loans from others:					
The entire loan has been repaid during the year. It was repayable in 60 monthly installments of ₹ 1.1 million per month starting from May 2018 and to be settled by May 2024.	Secured against all Property, plant and equipment of the company.	9.25% - 9.55%	41.84	54.81	68.75
The entire loan has been repaid during the year. It was repayable in 60 monthly installments of ₹ 0.15 million per month starting from May 2019 and to be settled by March 2025.	Secured against all Property, plant and equipment of the company.	9.55%	8.20	9.60	-

57. Details of security, repayment terms and interest rate for non-current and current borrowings:

Repayment and interest terms	Nature of Security	Interest rate p.a *	As at	As at	As at
			31 March 2021	31 March 2020	31 March 2019
3 Car loan from bank: Repayable in 60 monthly installments of ₹ 0.06 million per month starting from November 2017 and to be settled by October 2022.	Secured against all Property, plant and equipment of the company.	8.25%	1.06	1.70	2.29
Repayable in 37 monthly installments of ₹ 0.06 million per month starting from October 2018 and to be settled by October 2021.	Secured against all Property, plant and equipment of the company.	9.00%	0.42	1.10	1.72
4. Cash Credit -Citi Bank	Secured against all Inventory and Receivables of the company.	10.50%	-	-	64.34
-SBI Bank	Secured against all Inventory and Receivables of the company.	7.10% - 9.50%	40.95	-	372.97
5. Working capital loan (secured) -HDFC Bank	Secured against all Inventory and Receivables of the company.	6.75% - 8.80%	251.48	251.77	258.15
-SBI Bank	Secured against all Inventory and Receivables of the company.	7.10% - 8.70%	660.96	666.01	400.00
-Citi Bank	Secured against all Inventory and Receivables of the company.	8.05%	102.29	-	-
-Citi Bank	Secured against all Inventory and Receivables of the company.	3.50%	-	271.70	-
-HDFC Bank	Secured against all Inventory and Receivables of the company.	9.05%	207.70	208.71	208.61
-Bajaj Finance Limited	Secured against all Inventory and Receivables of the company.	9.50%	-	20.36	20.00
-Svenska Handelsbanken	Secured against all Inventory and Receivables of the company.	4.95% - 5.95%	-	34.60	90.68
-Citi Bank	Secured against all Inventory and Receivables of the company.	2.00%	296.15	-	-
6. Working capital loan -Bajaj Finance Limited	Secured against all Inventory and Receivables of the company.	8.75% - 9.10%	-	-	200.00
7. Foreign currency loan -Citi Bank	Secured against all Inventory and Receivables of the company	2.50%	-	-	464.81
8. Packing credit -Citi Bank	Secured against all Inventory and Receivables of the company	0.45% - 5.80%	702.29	1,000.00	100.00
-SBI Bank	Secured against all Inventory and Receivables of the company	0.65% - 1.25%	-	-	147.58
-DBS Bank	Secured against all Inventory and Receivables of the company	3.00% - 5.70%	90.45	345.00	330.90
-HSBC Bank	Secured against all Inventory and Receivables of the company	4.00% - 5.10%	200.05	180.28	-
9. Bill discounting facility from banks -HDFC Bank	Secured against all Inventory and Receivables of the company	9.05%	-	25.19	27.50
10. Unsecured Loans repayable on Demand -HDFC Bank	Unsecured	8.35% - 8.80%	-	100.00	100.00
-Bajaj Finance Limited	Unsecured	8.75% - 9.10%	-	450.50	257.60
Total			5,482.56	6,367.77	5,953.63

* It represents the range of interest rates between 01 April 2018 to 31 March 2021.

OTHER FINANCIAL INFORMATION

The accounting ratios required under Clause 11 of Part A of Schedule VI of the SEBI ICDR Regulations are given below:

(in ₹ million, except weighted average number of Equity Shares)

Particulars	As at and for the year ended March 31,		
	Fiscal 2021	Fiscal 2020	Fiscal 2019
Total equity attributable to owners of the company	8,782.42	7,681.78	6,853.82
Less: Capital reserve	8.17	8.17	8.17
Net worth (A)	8,774.25	7,673.61	6,845.65
Profit attributable to owners of the company (B)	1,079.86	803.10	962.13
Return on Net worth (B/A) (%)	12.31%	10.47%	14.05%
Weighted average number of Equity Shares outstanding during the year			
- basic (C)	51,377,850	51,377,850	51,377,850
- diluted (D)	52,551,625	52,551,625	52,551,625
Basic Earnings per share (in ₹) (B/C)	21.02	15.63	18.73
Diluted Earnings per share (in ₹) (B/D)	20.55	15.28	18.31
Basic Net Asset Value per share (in ₹) (A/C)	170.78	149.36	133.24
Diluted Net Asset Value per share (in ₹) (A/D)	166.96	146.02	130.27
EBITDA	2,952.14	2,406.66	2,919.86

Notes:

- 1) The above ratios are calculated as follows:
 - a. Return on Net worth is calculated as Profit attributable to owners of the company divided by Net worth. Net worth is calculated as Total equity attributable to owners of the company less Capital reserve
 - b. Basic Earnings per share is calculated as Profit for the year attributable to owners of the company divided by the weighted average number of basic equity shares outstanding during the year
 - c. Diluted Earnings per share is calculated as Profit for the year attributable to owners of the Company divided by the weighted average number of diluted equity shares outstanding during the year
 - d. Basic Net Asset Value per share is calculated as Net worth divided by the weighted average number of basic equity shares outstanding during the year
 - e. Diluted Net Asset Value per share is calculated as Net worth divided by the weighted average number of diluted equity shares outstanding during the year
- 2) Basic equity shares is calculated as current shares outstanding and shares to be issued upon conversion of Series A CCPS and Series B CCPS
- 3) Diluted equity shares is calculated as current shares outstanding and shares to be issued upon conversion of Series A CCPS and Series B CCPS and other potentially dilutive instruments
- 4) EBITDA is calculated as the sum of (i) Profit for the year, (ii) Total tax expenses, (iii) Depreciation and amortisation expense and (iv) Finance costs

In accordance with the SEBI ICDR Regulations, the audited standalone financial information of our Company for Fiscals ended March 31, 2021, 2020 and 2019 (collectively, the “**Audited Financial Statements**”) are available on our website at www.sansera.in/investor-quick-links/audited-financial-statements.pdf.

Our Company is providing a link to this website solely to comply with the requirements specified in the SEBI ICDR Regulations. The Audited Financial Statements do not constitute, (i) a part of this Red Herring Prospectus; or (ii) a prospectus, a statement in lieu of a prospectus, an offering circular, an offering memorandum, an advertisement, an offer or a solicitation of any offer or an offer document or recommendation or solicitation to purchase or sell any securities under the Companies Act, the SEBI ICDR Regulations, or any other applicable law in India or elsewhere. The Audited Financial Statements should not be considered as part of information that any investor should consider subscribing for or purchase any securities of our Company and should not be relied upon or used as a basis for any investment decision. None of our Company or any of its advisors, nor BRLMs or the Selling Shareholders, nor any of their respective employees, directors, affiliates, agents or representatives accept any liability whatsoever for any loss, direct or indirect, arising from any information presented or contained in the Audited Financial Statements, or the opinions expressed therein.

RELATED PARTY TRANSACTIONS

For details of the related party transactions, as per the requirements under applicable Accounting Standards, i.e., Accounting Standard (AS) 1 – Related Party Disclosures’ issued by the ICAI read with the SEBI ICDR Regulations, during Fiscals ended March 31, 2021, 2020 and 2019, see “Financial Statements – Note 41 – Related party disclosures” on page 261.

CAPITALISATION STATEMENT

The following table sets forth our capitalisation as at March 31, 2021, derived from our Restated Consolidated Financial Information, and as adjusted for the Offer. This table should be read in conjunction with “*Management’s Discussion and Analysis of Financial Condition and Results of Operations*”, “*Financial Statements*” and “*Risk Factors*” on pages 282, 219, and 22, respectively.

(₹ in million)

Particulars	Pre-Offer (as at March 31, 2021)	Post Offer*
Debt		
Current borrowings (A)	2,552.32	[●]
Non-current borrowings (including current maturity and accrued interest) (B)	2,945.17	[●]
Total borrowings (C=A+B)	5,497.49	[●]
Total equity attributable to owners of the company (D)	8,782.42	[●]
Non-controlling Interests (E)	104.99	[●]
Total equity (F=D+E)	8,887.41	[●]
Total non-current borrowings (including current maturities and accrued interest) / Total equity (B/F)	0.33	[●]
Total borrowings / Total equity (C/F)	0.62	[●]

**The corresponding post Offer capitalisation data for each of the amounts given in the above table is not determinable at this stage pending the completion of the Book Building Process and hence, the same have not been provided in this statement*

MANAGEMENT'S DISCUSSION AND ANALYSIS OF FINANCIAL CONDITION AND RESULTS OF OPERATIONS

Prospective investors should read the following discussion of our financial condition and results of operations together with our Restated Consolidated Financial Information, which are included in "Financial Statements" on page 219, along with "Industry Overview" and "Our Business" on pages 94 and 147, respectively.

This discussion and analysis contains forward-looking statements that reflect our current views with respect to future events and our financial performance, which are subject to numerous risks and uncertainties. Our actual results may differ materially from those anticipated in these forward-looking statements. As such, prospective investors should also read "Risk Factors" and "Forward Looking Statements" on pages 22 and 21, respectively, which discuss a number of factors and contingencies that could affect our financial condition and results of operations.

Our fiscal year commences on April 1 and ends on March 31 of the subsequent year. Accordingly, all references to a particular fiscal year, or "Fiscal", are to the 12 months ended March 31 of that year. Unless otherwise indicated or the context requires otherwise, the financial information included herein is based on our Restated Consolidated Financial Information.

Industry and market data used in this section have been derived from the CRISIL Report and the Ricardo Report, both of which were commissioned by our Company for the purpose of the Offer for an agreed fee. For more details, see "Risk Factors - Statistical and industry data in this Red Herring Prospectus are derived from the CRISIL Report and the Ricardo Report, both of which were commissioned by our Company for the purpose of the Offer for an agreed fee. Each of the CRISIL Report and the Ricardo Report is not exhaustive and is based on certain assumptions, parameters and conditions. The data and statistics in the CRISIL Report and the Ricardo Report may be inaccurate, incomplete or unreliable" on page 52.

Overview

We are an engineering-led integrated manufacturer of complex and critical precision engineered components across automotive and non-automotive sectors. Within the automotive sector, we manufacture and supply a range of precision forged and machined components and assemblies, such as connecting rod, rocker arm, crankshaft, gear shifter fork, stem comp, and aluminium forged parts, that are critical for engine, transmission, suspension, braking, chassis and other systems for the two-wheeler, passenger vehicle and commercial vehicle verticals. Within the non-automotive sector, we manufacture and supply a range of precision components for the aerospace, off-road, agriculture and other segments, including engineering and capital goods. We supply most of our products directly to OEMs in finished (forged and machined) condition, resulting in significant value addition by us. For Fiscal 2021, we derived 88.45%, and 11.55% of our revenue from sale of products from the automotive sector and non-automotive sectors, respectively. We are a global supplier and for Fiscal 2021 we derived 64.98% of our revenue from sale of products from India and 35.02% of our revenue from sale of products from Europe, USA and other foreign countries combined.

We are one of the top 10 global suppliers of connecting rods within the light vehicle segment (passenger vehicles with gross vehicle weight of 3.5 tonnes or less, "**Light Vehicle**") and one of top 10 global suppliers of connecting rods within the commercial vehicle ("**CV**") segment for CY 2020. (Source: the Ricardo Report, pages 42 and 43). We have been gaining market share in connecting rods in terms of production volume (units) for (i) Light Vehicles with a global market share of 2.3% in CY 2020 compared to a global market share of 0.9% in CY 2015 and (ii) CVs with a global market share of 3.0% in CY 2020 compared to a global market share of 0.9% in CY 2015. (Source: the Ricardo Report, pages 32 and 33).

Within India, we are one of the leading manufacturers of (i) connecting rods, crankshafts, rocker arms and gear shifter forks for two-wheelers and (ii) connecting rods and rocker arms for passenger vehicles. Specifically, we are the largest supplier of connecting rods, rocker arms and gear shifter forks to two-wheeler OEMs in India. We are the largest supplier of connecting rods and rocker arms to passenger vehicle OEMs in India. (Source: the CRISIL Report, pages 191, 194, 198 and 201).

We are a technology-driven company with a focus on design, engineering, machine building and automation capabilities. These capabilities enable us to roll out new products in a timely manner and develop higher strength components required for high-end performance and graduate from manufacturing individual parts to the designing and manufacturing of sub-assemblies, thereby moving us up the value chain. We possess machine building capabilities with several complex special purpose machines being manufactured in-house. As of July 31, 2021, we had built over 900 computer numerical control special purpose machines, which are deployed across our manufacturing facilities. Most of the machines we build are modular by design and can be refurbished for other applications in case of a reduction in demand or a phasing out of the product for which the machine was originally built, thereby reducing our capital expenditure requirements and de-risking our business model. Our automation division, which works concurrently with our machine design and machine building

divisions, has implemented multiple automation projects intended to increase our productivity and control labour costs. As of July 31, 2021, a team of 201 personnel supported our design, engineering, machine building, automation and technical support functions.

We believe our engineering capabilities, evolved over decades, have enabled us to consistently offer quality, complex, precision components and assemblies, allowing us to diversify our business beyond the automotive sector into various other sectors, including aerospace, off-road and agriculture. We sold components across 69 product families during Fiscal 2021 as compared to 51 during Fiscal 2019. Our recently developed products include (i) suspension, rotor and aluminium forged components for internal combustion engines (“ICE”) and electric two-wheelers (“e-2W”), (ii) steering system components and drive train parts for ICE and hybrid passenger vehicles, (iii) cabin tilt system components and braking system parts for CVs, (iv) suspension components for off-road vehicles, (v) common rail systems for agriculture and (vi) components for industrial engines within other non-automotive sectors. In addition, since April 1, 2021, we have developed (i) suspension and drive train components for electric two-wheelers, (ii) braking system components for passenger vehicles, (iii) machined engine casings for aerospace and (iv) components for power transmission. We also have an active pipeline of products under development, including components for the defence sector and the bicycle segment. For further details, see “*Our Business-Products Recently Developed / Under Development*” on page 164.

Within India, our customers include nine out of the top 10 two-wheeler OEMs and the leading passenger vehicle OEM based on production volume for Fiscal 2021. (*Source: the CRISIL Report, page 31*). Globally, our customers include six out of top 10 global Light Vehicle OEMs and three of the top 10 global MHCV OEMs based on production volumes for CY 2020. (*Source: the Ricardo Report, pages 6 and 18*). Owing to the critical applications of our products and stringent quality requirements, we believe it is difficult for new players to become qualified or replace us in supplying the precision components we provide. This is corroborated by our status as a single source supplier in certain product categories for some of our key customers and by our long-standing relationships with several Indian and global OEMs. In the two-wheeler vertical, we have relationships spanning over 20 years with HMSI, 25 fiscal years with Bajaj and over 20 years with Yamaha, the second, third and fifth largest two-wheeler Indian OEMs in terms of domestic production volume for Fiscal 2021, respectively. (*Source: the CRISIL Report, page 31*). In the passenger vehicle vertical, we have relationships spanning more than 30 years with Maruti Suzuki, the leading Indian passenger vehicle OEM in terms of domestic production volume for Fiscal 2021 (*Source: the CRISIL Report, page 54*), over 10 years with Stellantis N.V. (formerly Fiat Chrysler Automobiles), a leading European passenger vehicle OEM, (*source: the Ricardo Report, page 6*) and over 10 years with one of the leading North American passenger vehicle OEMs. We were suppliers to 71 customers during Fiscal 2021 as compared to 64 during Fiscal 2019, which helped to decrease our reliance on our top customer, Bajaj. For Fiscals 2021, 2020 and 2019, our top customer, Bajaj, contributed 20.75%, 22.08% and 22.71% of our revenues from sale of products, respectively.

We have received numerous awards over the years that bear testimony to our ability to successfully meet our clients’ requirements. Some of our recent awards include: the “Zero Defect Supplies” and “Best Quality Supplier” awards from Toyota Industries Engine India Private Limited, received in 2021 “Silver Boeing Performance Excellence Award” from Boeing in 2020; “Powertrain Supplier of the Year” from Fiat Chrysler Automobiles (now called Stellantis N.V.) in 2019; “Zero Defect Supply” from Toyota Kirloskar Motor in 2019; and “Quality Performance Award” from Volkswagen AG in 2017. For further details, see “*History and Certain Corporate Matters – Awards, accreditations and recognitions received by our Company*” on page 190.

As of July 31, 2021, we had 16 manufacturing facilities, of which 15 are in India in the states of Karnataka (Bengaluru, Bidadi, Tumkur), Haryana (Manesar), Maharashtra (Chakan), Uttarakhand (Pantnagar) and Gujarat (Mehsana), and one facility is in Trollhättan, Sweden.

Our manufacturing operations are (i) integrated across the product cycle with the entire manufacturing process (encompassing forging, heat treatment, precision machining, other specialized processing, assembly, testing and quality control) being carried out in-house and (ii) coordinated through concurrent design and engineering, machine building and automation divisions. This enables us to keep the core competencies required for our business within our Group, streamline our production processes, achieve shorter product development and delivery times, exercise greater control over key inputs and processes, reduce inventories and manage capital expenditure.

Significant Factors Affecting our Results of Operations and Financial Condition

Our results of operations have been, and will be, affected by many factors, some of which are beyond our control. The following is a discussion of certain factors that have had, and will continue to have, a significant effect on our financial condition and results of operations.

Effects of COVID-19

Fiscal 2021 was volatile for the global economy and the resurgence of COVID-19 cases in some countries has prompted

authorities to re-impose lockdowns to contain the spread of the virus. The International Monetary Fund (“IMF”) has raised a few lingering concerns: surging infections for new variants of the virus and renewed lockdowns, logistical problems with vaccine distribution and uncertainty about vaccine uptake. High-frequency data from some economies suggest that the pace of economic recovery has slowed down in the fourth quarter of CY 2020. Even with anticipated recovery, the IMF does not expect output gaps to close until after CY 2022. (Source: the CRISIL Report, page 5).

CRISIL Research estimates that India’s GDP will contract by 7.3% in Fiscal 2021. India had one of the world’s most stringent nation-wide lockdowns from March 2020, which halted production in early Fiscal 2021, and has been witnessing a second wave of COVID-19 cases since the end of February 2021, leading to state governments taking steps to control the spread, such as imposing curfews and lockdowns, resulting in loss of economic output. This second wave of COVID-19 cases and limited availability of vaccines in India along with likely future lockdowns are expected to subdue economic activity. (Source: the CRISIL Report, page 8).

Shortly after the World Health Organization (WHO) declared the outbreak of COVID-19 a global pandemic on March 11, 2020, the GoI implemented a nation-wide lockdown on March 23, 2020 (which was extended to May 31, 2020) and we temporarily suspended operations in all our manufacturing facilities in India in compliance with the lockdown instructions issued by the central and state governments of India. The table below sets forth the periods during which our manufacturing facilities and offices were shut down due to the COVID-19 pandemic.

Name of manufacturing facility	Period of shutdown (inclusive) / Days of shutdown ⁽¹⁾
Plant 1, Plant 2, Plant 3, Plant 7, Plant 10, Plant 11, Plant 12 and Plant 14 ⁽²⁾	March 23, 2020 to May 3, 2020 / 34 days
Plant 4	March 23, 2020 to May 5, 2020 / 38 days
Plant 5	March 23, 2020 to May 5, 2020 / 36 days
Plant 6	March 23, 2020 to April 20, 2020 / 25 days
Plant 9	March 23, 2020 to April 7, 2020 / 14 days
Plant 15	March 23, 2020 to June 30, 2020 / 85 days
Fitwel Plant 1 and Fitwel Plant 2	March 23, 2020 to May 3, 2020 / 34 days

Notes:

- (1) The number of days a plant was shut down for does not include Sundays and declared holidays.
- (2) Plant 8 was also shut down but it is used for training, quality systems and new product development and not for manufacturing.

We experienced overall low demand during the lockdown, which resulted in fewer orders for our products, and although the nation-wide lockdown was lifted on June 1, 2020, production in our manufacturing facilities continued to be adversely affected due to the unavailability of some of our workforce, supply chain disruption and issues around timely availability and transportation of raw materials. Overall capacity utilisation rates at our manufacturing facilities returned to approximate pre-COVID-19 levels in July 2020.

Our results of operations for Fiscal 2021 and Fiscal 2020 would have been better had it not been for the shutdown of our plants in India for various periods in the first quarter of Fiscal 2021 and the last quarter of Fiscal 2020. The table below shows our revenue from the sale of products for each of the quarters in Fiscal 2021 and Fiscal 2020.

Quarter ended	Fiscal 2021		Fiscal 2020	
	Revenue (₹ in million)	% of Revenue from Sale of Products	Revenue (₹ in million)	% of Revenue from Sale of Products
June 30 (unaudited)	1,354.60	9.30%	3,715.54	26.67%
September 30 (unaudited)	4,111.90	28.22%	3,550.56	25.49%
December 31 (unaudited)	4,593.53	31.53%	3,265.06	23.44%
March 31 (unaudited)	4,508.87	30.95%	3,399.22	24.40%
Total Revenues from Sale of Products	14,568.90	100.00%	13,930.38	100.00%

For more information on the effects of COVID-19 and the lockdown and restrictions, see “Risk Factors – The COVID-19 pandemic has had, and we expect it to continue to have, a material adverse effect on our business, financial condition, results of operations and cash flows” on page 22.

While our business has been resilient in the face of the pandemic, as evidenced by our profit for the year increasing by 37.49% to ₹ 1,098.60 million for Fiscal 2021 from ₹ 799.05 million for Fiscal 2020, we cannot predict whether such resilience will continue. Changes to government restrictions in connection with COVID-19 or new strains of COVID-19 could adversely affect our business, financial condition, results of operations and cash flows.

Market and Economic Conditions

We derive a significant portion of our revenue from sales of complex and high-quality precision engineered components

for the automotive and non-automotive sectors, primarily supplying to OEMs in India and internationally. The level of demand for precision forged and machined components depends primarily on conditions in the automotive and non-automotive sectors in our target markets, which, in turn, depend to a large extent on general economic conditions in these markets. General economic factors can affect demand in the automotive and the non-automotive sectors that we supply to, and therefore can affect demand for our products, including, among others:

- global oil prices, which impact the demand for automotive and non-automotive components;
- global and local economic or fiscal instability;
- global and local political and regulatory measures and developments, such as tax incentives or other subsidies, environmental policies, the phasing out of older vehicles or other developing trends, such as the move towards electrification and emissions reduction;
- global and local fiscal and monetary dynamics, such as rises or falls in interest rates (resulting in greater or lesser ability by customers to borrow money, including for automotive purchases), foreign exchange rates and inflation rates;
- general levels of GDP growth in a country or region, and growth in personal disposable income in that country or region;
- demographic conditions and population dynamics, such as the absolute size of a market and the growth rates of the population in that market; and
- economic development, shifting of wealth in India, in particular growth in the middle class, and change in customer preferences in favour of more fuel efficient and environmentally friendly vehicles.

Stronger economic indicators tend to correlate with higher demand for automotive and non-automotive components, while weaker economic indicators tend to correlate with lower demand for such components.

The cyclical nature of general economic conditions and, therefore, of the automotive and the non-automotive sectors means that our results of operations can fluctuate substantially from period to period. We expect that these economic factors and conditions in our industry, particularly changes in consumer confidence, employment levels, fuel prices, consumer spending on two-wheelers and passenger vehicles, urbanisation, changes in consumer preferences, government policies and interest rates, will continue to be the most important factors affecting our results of operations. In addition, the COVID-19 pandemic will continue to have an adverse effect on our results of operations. Other factors, such as our competitiveness, quality and pricing, have an effect on our market share and our ability to win customers in competitive situations.

Purchasing Pattern of our Major Customers and Terms of Supply Arrangements

Our ability to manage and sustain customer relationships is critical to our business. We depend on our major OEM customers for a significant portion of our revenues. Our top five customers accounted for 59.21%, 59.46% and 60.01% of our revenue from sale of products for Fiscals 2021, 2020 and 2019, respectively. The loss of any key customers, including as a result of a dispute with or disqualification by them, may materially affect our business and results of operations.

The demand from our top customers has a very large influence on our revenue from sale of products and results of operations, and our sales are directly affected by the production and inventory levels of our customers. New investments or increased sales by our customers tend to increase our revenue from sale of products and results of operations, while a slow-down in demand for our customers' products tends to have an adverse effect on our revenue from sale of products and results of operations. We expect successful new model launches by these customers to likely increase our revenue from sale of products and results of operations. Accordingly, our operations have generally grown with our customers' businesses over time. Our customers, in turn, are dependent on general trends in the automotive and non-automotive industries. See “- *Market and Economic Conditions*” above. Foreign exchange rate fluctuations may also subdue exports for some of our customers, thereby affecting the volumes that we supply. For more details, see “*Risk Factors – We are exposed to risks associated with foreign exchange rate fluctuations*” on page 32.

Our sales to customers also depend largely on the number and type of products that we supply to them and our ability to increase our overall share of customers' purchases. It is difficult for us to predict with certainty when our customers will decide to increase or decrease inventory levels or levels of production, which strategic direction they will pursue, when they might launch new models or open new facilities, or whether future inventory levels will be consistent with historical levels. For instance, some OEMs are pursuing a strategy of localisation of production for each market, while others are consolidating their global platforms in one low-cost manufacturing jurisdiction for eventual distribution to other countries. In addition, certain OEMs are seeking to consolidate their suppliers, particularly with suppliers who are able to manufacture complex and high-quality components, scale up production and supply products across a number of geographies. (*Source: CRISIL Report, page 189*).

Moreover, the long lead times for automobile models and the related programmes for the development and manufacture of these products make it difficult to predict the exact timing and exact levels of sales that we will derive from these arrangements. Any increases or decreases in the levels of inventory and activity by our customers, in turn, are likely to have a positive or negative effect on our revenues and our results of operations.

We do not generally have firm commitment supply agreements with most of our customers and instead rely on purchase orders that set out the volume and other terms of our sales of products. Most of our customers provide us with forecasts of order volumes, generally for the immediate month and with a tentative delivery schedule for the following month, that help us predict our production volumes for that particular product. Our actual production volumes may differ from our estimates due to variations in customer demand for the related vehicles. When actual production volumes differ significantly from our estimates, we generally seek to make up any shortfalls through new orders, either with existing or with new customers, which may or may not materialise or materialise with a time lag. For further details, see “*Our Business – Sales and Marketing – Customer Agreements*” and “*Risk Factors – We do not have firm commitment long-term supply agreements with our customers. If our customers choose not to source their requirements from us, there may be a material adverse effect on our business and results of operations*” on pages 178 and 24, respectively.

Raw Material and Employee Benefit Expenses

Cost of Materials, which consist of (i) cost of material consumed, (ii) changes in inventory of finished goods and work-in-progress and (iii) conversion charges, constitute the most significant portion of our expenses. Our Cost of Materials for Fiscals 2021, 2020 and 2019 were ₹ 7,160.75 million, ₹ 6,749.83 million and ₹ 7,521.81 million, respectively, representing 45.54%, 45.82% and 45.84% of our total income for the respective year. Cost of materials consumed primarily consists of (i) the cost of raw materials that we consume in the manufacture of our products (our primary raw materials includes alloy steel round bars, and non-ferrous alloys, such as aluminium and titanium); and (ii) the cost of assembled components, such as roller bearings, screws, crank pins, bolts, bushes and sintered tips.

We primarily purchase raw materials either from suppliers stipulated by our customers or those suggested by us and approved by our customers.

Prices for these raw materials can be volatile and depend on commodity prices in the markets, which in turn depend on changes in global economic conditions, industry cycles, supply-and-demand dynamics, attempts by individual producers to capture market share, and market speculation, among other factors. In addition to market fluctuations, our average raw material prices can be affected by contractual arrangements and hedging strategies, if any. While we enter into general purchase agreements with our suppliers, we do not enter into any firm commitment for long-term contracts. See “*Risk Factors – We depend on third parties with whom we do not have long-term supply contracts for the supply of raw materials. A loss of suppliers or interruptions in the delivery of raw materials or volatility in the prices of raw materials on which we rely may have a material adverse effect on our business and results of operations*” on page 34.

While in practice we have passed the increase in the cost of raw materials on to our domestic customers, our cash flows may still be adversely affected due to any gap in time between the date of procurement of those raw materials and the date on which we can reset the component prices for our customers so as to account for the increase in the prices of such raw materials. In addition, we may not be able to pass all of our raw material price increases on to our customers. Our ability to adjust pricing terms with customers varies based on our specific customer relationships, market practice with respect to the particular raw material or component and other factors such as raw material content and whether medium-term price fluctuations have been factored into our component prices at the time of price finalisation. As a result, for some of our export customers, we may in some instances bear the risk of price increases that occur. Further, an increase in raw material prices may result in increased prices for our customers’ products, which may in turn result in decreased demand for their products and, consequently, decreased demand for the components that we supply for their products.

Employee benefit expenses comprise our second largest expense after cost of material consumed. In Fiscals 2021, 2020 and 2019, our employee benefit expenses represented 13.59%, 14.49% and 13.25% of our total income, respectively. We seek to reduce our employee benefit expenses as a percentage of our total income by improving our operational efficiency. As a material portion of our overall manpower is located in India, rising wages in India as well as any change in applicable labour laws, would increase our costs.

Operating Costs and Efficiencies

Given the nature of our business, operating costs and efficiencies are critical to maintaining our competitiveness and profitability. Our profitability is partially dependent on our ability to spread fixed production costs over higher production volumes. In addition, we face pressure from our customers to reduce prices, and in order to maintain our profitability, we must be able to reduce our operating expenses.

Our operations are integrated across the product cycle and coordinated through concurrent engineering and design, machine building and automation. This vertical integration of our operations has enabled us to streamline our production processes, achieve shorter development and delivery times, exercise greater control over key inputs and processes, enhance quality control and increase supply security. We continually undertake efforts to reduce our costs, such as negotiating volume discounts, outsourcing non-critical processes, reducing energy usage and rationalising our labour. Our ability to reduce our operating costs in line with customer demand is subject to risks and uncertainties, as our costs depend, in part, on external

factors beyond our control.

We also incur certain costs in order to ensure that the products that we supply to our customers are of high quality and free of defects. Such costs relate to matters such as capital expenditure, testing and validation, systems deployment and rejection and re-working of products. Quality control is critical to our operations and a failure to prevent the passing down of defects to our customers may lead to significant financial penalties.

Exchange Rates

Although our Company's reporting currency is in Indian Rupees, we transact a significant portion of our business in several other currencies. Certain portions of our income and expenses are generated or incurred in other currencies and certain portions of our assets (trade receivables and cash and cash equivalents) and liabilities (trade payables and borrowings) are in other currencies, such as the USD, SEK and Euro.

Our subsidiary, Sansera Sweden, primarily undertakes its operations in Euro and SEK and reports its financial results in SEK. Our subsidiary, Sansera Mauritius, which is the holding company for Sansera Sweden, reports its financial results in Euro, which are then translated to Indian Rupees for the purpose of consolidation.

We consolidate our offshore assets and liabilities on our balance sheet based on the year-end closing exchange rate, and we consolidate our offshore operations in our profit and loss statement on the basis of the average exchange rate for the year. Hence, the carrying value of our offshore assets on our balance sheet as well as the value of our revenue and expenses from our offshore operations on our profit and loss statement depend significantly on the underlying SEK-to-Euro, Rupee-to-SEK and Rupee-to-Euro exchange rate movements.

In Fiscals 2021, 2020 and 2019, our revenue from contracts with customers from customers based outside of India (comprising Europe, USA and other foreign countries) was ₹ 5,312.68 million, ₹ 4,318.37 million and ₹ 4,813.94 million, respectively, which represented 35.83%, 30.85% and 31.06% of our revenue from contracts with customers, respectively. The exchange rates between the Indian Rupee and the currencies in which we receive payments for such exports, primarily the USD and Euro, have fluctuated in the past and our results of operations have been impacted by such fluctuations in the past and may be impacted by such fluctuations in the future. Due to our inherent net foreign currency long position, depreciation of the Indian Rupee against foreign currencies will generally have a positive effect on our reported revenues and operating income and appreciation of the Indian Rupee against foreign currencies will generally have a negative effect on our reported revenues and operating income. There can be no guarantee that such fluctuations will not adversely affect our results of operations. However, the positive effect on depreciation of the Indian Rupee may not be sustained or may not show an appreciable impact in our results of operations in any given financial period due to other variables impacting our results of operations during the same period. Moreover, we expect that our cost of borrowing as well as our cost of imported raw materials, imported stores and spares, overseas professional costs, freight and other expenses incurred by us may rise during a sustained depreciation of the Indian Rupee against the USD or Euro.

Our exchange rate risk primarily arises from (i) currency mismatches between our income and our expenditure, which we seek to mitigate by matching income currency to expenditure currency to the extent possible and through forward contracts; (ii) our foreign currency borrowings, in respect of which we selectively hedge currency exchange rate risk; and (iii) currency translations for the purpose of preparing our consolidated financial statements on account of our operations in Sweden.

We hedge a significant portion of our net foreign exchange exposure through forward contracts and foreign currency borrowings. We are exposed to foreign currency risk on the unhedged exposure of foreign currency borrowings as well as translation of receivables, bank balances, trade payables and borrowings. As of March 31, 2021, our total foreign currency receivables amounted to ₹ 1,668.47 million, our total cash and cash equivalents in foreign currency amounted to ₹ 51.80 million, our total trade payables amounted to ₹ 237.60 million and our total foreign currency borrowings amounted to ₹ 290.04 million. As of March 31, 2021, the total value of our outstanding forward contracts against net receivables and borrowings amounted to ₹ 2,455.67 million. For additional quantitative disclosures on foreign currency risk, see "*Financial Statements – Note 45-Financial Risk Management – (vi) Foreign currency risk*" on page 267.

Our net foreign exchange gains for Fiscals 2021, 2020 and 2019 amounted to ₹ 101.80 million, ₹ 104.64 million and ₹ 118.73 million, respectively.

Funding Mix and Cost of Funding

We rely primarily on internal cash generated from our operations and third-party debt to fund our working capital and capital expenditure requirements. Interest expenses on our borrowings have historically formed a material part of our expenses. Most of our borrowings bear interest at floating rates, and to the extent that interest rates decrease over time, this has a positive impact on our expenses (assuming constant levels of borrowings). Conversely, rising interest rates result in increasing expenses, unless we reduce the overall level of our borrowings.

In order to reduce our finance costs, we have sought to refinance higher cost loans in India at lower costs. We have been able to do this as our credit rating in India has been steady, allowing us to access more cost-effective credit. Our Company's long-term bank facilities are domestically rated by ICRA as [ICRA] AA-/Stable and by India Ratings as Ind AA-/Stable and our Company's short-term bank facilities are domestically rated by ICRA as [ICRA] A1+ and by India Ratings as Ind A1+. Our ICRA rating history is as follows:

Rating history	Fiscal 2021	Fiscal 2020	Fiscal 2019
Long-term bank facilities	[ICRA] AA- (Stable)	[ICRA] AA- (Stable)	[ICRA] AA- (Positive)
Short-term bank facilities	[ICRA] A1+	[ICRA] A1+	[ICRA] A1+

Introduction of New Product Families and Acquisition of New Customers

We believe our engineering capabilities, evolved over decades, have enabled us to consistently offer quality, complex, precision manufactured components and assemblies, allowing us to diversify our business and add new products for both automotive and non-automotive sectors as indicated below.

	Fiscal 2021	Fiscal 2020	Fiscal 2019
Total number of product families sold	69	58	51

Our recently developed products include (i) suspension, rotor and aluminium forged components for ICE and e-2W, (ii) steering system components and drive train parts for ICE and hybrid passenger vehicles, (iii) cabin tilt system components and braking system parts for CVs, (iv) suspension components for off-road vehicles, (v) common rail systems for agriculture and (vi) components for industrial engines within other non-automotive sectors. Set forth below is a table showing the revenue from our key product families developed and such revenue as a percentage of our total revenue from sale of products for the periods stated.

Particulars	Fiscal 2021		Fiscal 2020		Fiscal 2019	
	Revenue (₹ in million)	% of Revenue from Sale of Products	Revenue (₹ in million)	% of Revenue from Sale of Products	Revenue (₹ in million)	% of Revenue from Sale of Products
Suspension components	550.54	3.78%	144.39	1.04%	0.05	0.00%
Aluminium forged components	98.74	0.68%	24.73	0.18%	-	-
Others	49.81	0.34%	23.90	0.17%	5.54	0.04%
Total	699.09	4.80%	193.02	1.39%	5.59	0.04%

In addition, since April 1, 2021, we have developed (i) suspension and drive train components for electric two-wheelers, (ii) braking system components for passenger vehicles, (iii) machined engine casings for aerospace and (iv) components for power transmission. We also have an active pipeline of products under development, including components for the defence sector and the bicycle segment. For further details, see "Our Business-Products Recently Developed / Under Development" on page 164.

Our varied product offerings and continuous product development efforts have enabled us to attract new customers. We have a diverse customer base in India and 24 other countries across North America, Latin America, Europe and Asia, and a consistent track record of adding to our total numbers of customers over the years as indicated below:

	Fiscal 2021	Fiscal 2020	Fiscal 2019
Total number of customers	71	68	64

Key Performance Indicators and Certain Non-GAAP Measures

In evaluating our business, we consider and use certain non-GAAP financial measures and key performance indicators that are presented below as supplemental measures to review and assess our operating performance. The presentation of these non-GAAP financial measures and key performance indicators are not intended to be considered in isolation or as a substitute for the Restated Consolidated Financial Information. We present these non-GAAP financial measures and key performance indicators because they are used by our management to evaluate our operating performance. These non-GAAP financial measures are not defined under Ind AS and are not presented in accordance with Ind AS. The non-GAAP financial measures and key performance indicators have limitations as analytical tools. Further, these non-GAAP financial measures and key performance indicators may differ from the similar information used by other companies, including peer companies, and hence their comparability may be limited. Therefore, these matrices should not be considered in isolation or construed as an alternative to Ind AS measures of financial performance or as an indicator of our financial condition, results of operations or cash flows.

Particulars	As at and for the year ended March 31,		
	2021 ⁽⁷⁾	2020 ⁽⁷⁾	2019
	(₹ in million, except percentages and ratios)		
Total Income	15,723.64	14,731.39	16,408.09
EBITDA ⁽¹⁾	2,952.14	2,406.66	2,919.86
EBITDA Margin ⁽²⁾ (%)	18.78%	16.34%	17.80%
Profit for the year ("PAT")	1,098.60	799.05	980.64
PAT Margin ⁽³⁾ (%)	6.99%	5.42%	5.98%
RoCE ⁽⁴⁾ (%)	15.11%	12.88%	19.36%
Net Debt ⁽⁵⁾	4,846.07	5,651.33	5,637.63
Net Debt to Equity Ratio ⁽⁶⁾	0.55	0.73	0.81

Notes:

1. EBITDA is calculated as the sum of (i) Profit for the year, (ii) Total tax expenses, (iii) Depreciation and amortisation expense and (iv) Finance costs.
2. EBITDA Margin is calculated as EBITDA divided by Total Income.
3. PAT Margin is calculated as Profit for the year divided by Total Income.
4. RoCE (Return on Capital Employed) is calculated as Earnings before Interest and Tax divided by Capital Employed. Earnings before Interest and Tax is defined as EBITDA less Depreciation and amortisation expense. Capital Employed is defined as the Total assets less Total current liabilities as on the last day of the fiscal year.
5. Net Debt is calculated as the sum of (i) non-current borrowings, (ii) current borrowings, (iii) current maturities of non-current borrowings and (iv) accrued interest less (i) Cash and cash equivalents and (ii) Bank balances other than cash and cash equivalents.
6. Net Debt to Equity Ratio is calculated as Net Debt divided by Total equity.
7. Fiscals 2021 and 2020 were impacted by the nationwide COVID-19 lockdown in India.

The following table sets forth our EBITDA and EBITDA Margin, which are non-GAAP financial measures, for Fiscals 2021, 2020 and 2019.

Particulars	For the year ended March 31,		
	2021	2020	2019
	(₹ in million, percentages)		
Profit for the year	1,098.60	799.05	980.64
Add:			
Total tax expenses	362.85	87.71	668.87
Finance costs	473.93	580.90	512.81
Depreciation and amortization expense	1,016.76	939.00	757.54
EBITDA (A)	2,952.14	2,406.66	2,919.86
Total Income (B)	15,723.64	14,731.39	16,408.09
EBITDA Margin (A/B) (%)	18.78%	16.34%	17.80%

The following table sets forth our PAT Margin, which is a non-GAAP financial measure, for Fiscals 2021, 2020 and 2019.

Particulars	For the year ended March 31,		
	2021	2020	2019
	(₹ in million, percentages)		
Profit for the year (PAT) (A)	1,098.60	799.05	980.64
Total Income (B)	15,723.64	14,731.39	16,408.09
PAT Margin (A/B) (%)	6.99%	5.42%	5.98%

The following table sets forth our RoCE, which is a non-GAAP financial measure, for Fiscals 2021, 2020 and 2019.

Particulars	As at and for the year ended March 31,		
	2021	2020	2019
	(₹ in million, percentages)		
EBITDA	2,952.14	2,406.66	2,919.86
Less:			
Depreciation and amortisation expense	1,016.76	939.00	757.54
EBIT (A)	1,935.38	1,467.66	2,162.32
Total Assets	19,288.83	18,282.36	17,454.84
Less:			
Total current liabilities	6,477.65	6,890.87	6,283.09

Particulars	As at and for the year ended March 31,		
	2021	2020	2019
	(₹ in million, percentages)		
Capital Employed (B)	12,811.18	11,391.49	11,171.75
RoCE (A/B) (%)	15.11%	12.88%	19.36%

The following table sets forth our Net Debt and Net Debt to Equity Ratio, which are non-GAAP financial measures:

Particulars	Fiscal 2021	Fiscal 2020	Fiscal 2019
	(₹ in million, except ratios)		
Non-current borrowings	1,876.52	1,718.25	2,133.84
Current borrowings	2,552.32	3,554.12	3,043.08
Current maturities of non-current borrowings	1,053.72	1,095.40	776.71
Accrued interest	14.93	-	-
Gross Debt	5,497.49	6,367.77	5,953.63
Less:			
Cash and cash equivalents	365.00	600.08	239.27
Bank balances other than cash and cash equivalents	286.42	116.36	76.73
Net Debt (A)	4,846.07	5,651.33	5,637.63
Total equity (B)	8,887.41	7,768.56	6,945.18
Net Debt to Equity Ratio (A/B)	0.55	0.73	0.81

Basis of Preparation of the Restated Consolidated Financial Information

Principles of Consolidation

The Restated Consolidated Financial Information include the results of the following subsidiaries:

S. No.	Name of the Entity	Country of Incorporation	Company's Effective Shareholding (%)
1	Fitwel	India	70.00
2	Sansera Sweden	Sweden	100.00
3	Sansera Mauritius	Mauritius	100.00

Judgements, Estimates and Assumptions

The preparation of the Restated Consolidated Financial Information in conformity with Ind AS requires management to make judgements, estimates and assumptions that affect the application of accounting policies and the reported amounts of assets, liabilities, income and expenses. Actual results may differ from these estimates. Estimates and underlying assumptions are reviewed on an ongoing basis. Revisions to accounting estimates are recognised in the period in which the estimates are revised and in any future periods affected.

Judgements

Information about judgements made in applying accounting policies that have the most significant effects on the amounts recognised in the Restated Consolidated Financial Information is included in lease classification.

Assumptions and Estimation Uncertainties

Information about assumptions and estimation uncertainties that have a significant risk of resulting in a material adjustment is included in the following notes to the Restated Consolidated Financial Information:

- Notes No. 2(a), 2(b), 3(a) and 3(b) - Depreciation and amortisation method and useful life of items of property, plant and equipment and intangibles assets;
- Note 40 – Recognition of deferred tax assets;
- Notes 21, 27 and 42 – Measurement of defined benefit obligations: key actuarial assumptions;
- Notes 3(a) and 3(b) – Impairment of property, plant and equipment;

- Note 45 – Impairment of financial assets;
- Note 51 – Impairment of goodwill; and
- Notes 15 and 26 – Derivative contracts at fair value.

For more details on the basis of the preparation of the Restated Consolidated Financial Information, see “*Financial Statements – Note 1-Basis of Preparation*” on page 228.

Significant Accounting Policies

a. Property, plant and equipment

i. Recognition and measurement

Property, plant and equipment are measured at cost, less accumulated depreciation and accumulated impairment losses, if any.

Cost of an item of property, plant and equipment comprises its purchase price, including import duties and non-refundable purchase taxes, after deducting trade discounts and rebates, any directly attributable cost of bringing the item to its working condition for its intended use and estimated costs of dismantling and removing the item and restoring the site on which it is located.

All items of property, plant and equipment are stated at historical cost less depreciation. Historical cost includes expenditure that is directly attributable to the acquisition of the items. Subsequent costs are included in the asset’s carrying amount or recognised as a separate asset, as appropriate, only when it is probable that future economic benefits associated with the item will flow to the Group and the cost of the item can be measured reliably. The carrying amount of any component accounted for as a separate asset is derecognised when replaced. All other repairs and maintenance are charged to profit or loss during the reporting period in which they are incurred.

If significant parts of an item of property, plant and equipment have different useful lives, then they are accounted for as separate items (major components) of property, plant and equipment.

Any gain or loss on disposal of an item of property, plant and equipment is recognised in the restated consolidated statement of profit or loss.

Borrowing costs directly attributable to the acquisition/construction of the qualifying asset are capitalized as part of the cost of that asset. Other borrowing costs are recognized as expense in the restated consolidated statement of profit and loss in the period in which they are incurred.

ii. Depreciation methods, estimated useful lives and residual values

Depreciation is provided on a Straight Line Method (“SLM”) over the useful life of property, plant and equipment as prescribed under Part C of Schedule II of the Companies Act, 2013. Depreciation for assets purchased/sold during a period is proportionately charged. The useful lives for property, plant and equipment is as follows:

Asset category	Estimated useful life (in years)
Buildings	30
Plant and machinery	15
Furniture and fixtures	10
Vehicles	8
Office equipment	5
Electrical installations	10
Computer (including software)	3-6

Freehold land is not depreciated.

b. Business combination, Goodwill and Intangible assets

Business combinations, other than through common control transactions, are accounted for using the purchase (acquisition) method in accordance with Ind AS 103, Business Combinations. The cost of an acquisition is measured as the fair value of the assets given, equity instruments issued and liabilities incurred or assumed at the date of exchange. The cost of acquisition also includes the fair value of any contingent consideration. Identifiable assets acquired and liabilities and contingent liabilities assumed in a business combination are measured initially at their fair value on the date of acquisition.

Business combinations through common control transactions are accounted on a pooling of interests method. Transaction costs incurred in connection with a business combination are expensed as incurred.

(i) Goodwill:

The excess of the cost of acquisition over the Group's share in the fair value of the acquiree's identifiable assets, liabilities and contingent liabilities is recognized as goodwill. Any goodwill that arises is tested annually for impairment.

(ii) Customer relationships:

Ind AS 103 requires the identifiable intangible assets and contingent consideration to be fair valued in order to ascertain the net fair value of identifiable assets, liabilities and contingent liabilities of the acquiree. Significant estimates are required to be made in determining the value of contingent consideration and intangible assets. These valuations are conducted by independent valuation experts. Such intangible assets are subsequently measured at cost less accumulated amortisation and accumulated impairment losses. The estimated useful life for customer relationship is expected to be 7 years. The residual values, useful lives and method of amortisation of intangible assets are reviewed at each financial year end and adjusted if appropriate.

c. Inventories

Inventories are measured at the lower of cost and net realisable value ("NRV"). Cost comprises purchase price and all expenses incurred in bringing the inventory to its present location and condition. Cost has been determined as follows:

- Raw material, stores and spares: on weighted average basis;
- Work in progress: includes cost of conversion; and
- Finished goods: includes cost of conversion.

Fixed production overheads are allocated on the basis of normal capacity of production facilities. The comparison of cost and NRV is made on an item-by-item basis. Spare parts that meets the definition of asset are capitalised at their respective carrying amounts. The NRV of work-in-progress is determined with reference to NRV of related finished goods.

Raw materials and other supplies held for use in production of inventories are not written down below cost except in cases where material prices have declined, and it is estimated that the cost of the finished products will exceed their NRV.

Provision for inventory obsolescence is assessed periodically and is provided as considered necessary

d. Revenue recognition

The Group recognises revenue to depict the transfer of control of promised goods or services to customers in an amount that reflects the consideration to which the Group expects to receive in exchange for those goods or services. A 5-step approach is used to recognise revenue as below:

Step 1: Identify the contract(s) with a customer;

Step 2: Identify the performance obligation in contract;

Step 3: Determine the transaction price;

Step 4: Allocate the transaction price to the performance obligations in the contract; and

Step 5: Recognise revenue when (or as) the entity satisfies a performance obligation.

Revenue is recognised upon transfer of control of goods or services to buyer in an amount that reflects the consideration which the Group expects to receive in exchange for those goods or services.

Sale of products is adjusted net of Goods and Service tax, returns, trade discounts, and volume rebates. Service income is recognized when the related services are rendered unless significant future contingencies exist.

Export incentives are recognised in the restated consolidated statement of profit and loss when the right to receive credit as per the terms of the entitlement is established in respect of the export made.

Dividend income is recognised in restated consolidated statement of profit and loss on the date on which the right to receive the payment is established. Interest on the deployment of funds is recognised using the time-proportion method, based on

underlying interest rates.

e. Foreign currency transactions and balances

Foreign currency transactions are translated into the functional currency using the exchange rates at the dates of the transactions. Foreign exchange gains and losses resulting from the settlement of such transactions and from the translation of monetary assets and liabilities denominated in foreign currencies at year end exchange rates are generally recognised in the restated consolidated statement of profit and loss.

Foreign exchange differences regarded as an adjustment to borrowing costs are presented in the restated consolidated statement of profit and loss, within finance costs. All other foreign exchange gains and losses are presented in the restated consolidated statement of profit and loss on a net basis within other gains/ (losses). Non-monetary items that are measured at fair value in a foreign currency are translated using the exchange rates at the date when the fair value was determined. Translation differences on assets and liabilities carried at fair value are reported as part of the fair value gain or loss.

Goodwill and fair value adjustments arising on the acquisition of a foreign entity are treated as assets and liabilities of the foreign entity and translated at the exchange rate in effect at the balance sheet date.

Foreign currency gains and losses are reported on a net basis. This includes changes in the fair value of foreign exchange derivative instruments, which are accounted at fair value through profit or loss.

f. Government grants

Government grants are recognised at their fair value where there is reasonable assurance that the grant will be received and the Group will comply with all attached conditions.

Grants related to assets are government grants whose primary condition is that an entity qualifying for them should purchase, construct or otherwise acquire long-term assets. Grants related to income are government grants other than those related to assets.

Government grants relating to an expense item are recognized in the restated consolidated statement of profit and loss over the period necessary to match them with the costs that they are intended to compensate and presented as a deduction in reporting the related expense. The presentation approach is applied consistently to all similar grants.

Government grants relating to the purchase of property, plant and equipment are included in liabilities as deferred income and are credited to the restated consolidated statement of profit and loss over the periods and in proportions in which depreciation expense on those assets is recognized.

Income from export incentives is recognized in the restated consolidated statement of profit and loss when the right to receive credit as per the terms of the entitlement is established in respect of exports made and disclosed as other operating revenues.

Income from government incentives (other than export incentive) are recognized in the restated consolidated statement of profit and loss when the right to receive credit as per the terms of the entitlement and disclosed as a reduction to the related expenses.

g. Leases

A contract is, or contains, a lease if the contract conveys the right to control the use of an identified asset for a period of time in exchange for consideration.

Group as a lessee

The Group accounts for each lease component within the contract as a lease separately from non-lease components of the contract and allocates the consideration in the contract to each lease component on the basis of the relative stand-alone price of the lease component and the aggregate stand-alone price of the non-lease components.

The Group recognises a right-of-use asset representing its right to use the underlying asset for the lease term at the lease commencement date and a lease liability at the lease commencement date. The cost of the right-of-use asset measured at inception shall comprise the amount of the initial measurement of the lease liability adjusted for any lease payments made at or before the commencement date less any lease incentives received, plus any initial direct costs incurred and an estimate of costs to be incurred by the lessee in dismantling and removing the underlying asset or restoring the underlying asset or site on which it is located. The right-of-use assets is subsequently measured at cost less any accumulated depreciation, accumulated impairment losses, if any and adjusted for any remeasurement of the lease liability. The right-of-use assets is

depreciated using the straight-line method from the commencement date over the shorter of lease term or useful life of right-of-use asset. The estimated useful lives of right-of-use assets are determined on the same basis as those of property, plant and equipment. Right-of-use assets are tested for impairment whenever there is any indication that their carrying amounts may not be recoverable. Impairment loss, if any, is recognised in the restated consolidated statement of profit and loss.

The Group measures the lease liability at the present value of the lease payments that are not paid at the commencement date of the lease. The lease payments are discounted using the interest rate implicit in the lease, if that rate can be readily determined. If that rate cannot be readily determined, the Group uses incremental borrowing rate. For leases with reasonably similar characteristics, the Group, on a lease by lease basis, may adopt either the incremental borrowing rate specific to the lease or the incremental borrowing rate for the portfolio as a whole. The lease payments shall include fixed payments, variable lease payments, residual value guarantees, exercise price of a purchase option where the Group is reasonably certain to exercise that option and payments of penalties for terminating the lease, if the lease term reflects the lessee exercising an option to terminate the lease. The lease liability is subsequently remeasured by increasing the carrying amount to reflect interest on the lease liability, reducing the carrying amount to reflect the lease payments made and remeasuring the carrying amount to reflect any reassessment or lease modifications or to reflect revised in-substance fixed lease payments. The Group recognises the amount of the re-measurement of lease liability due to modification as an adjustment to the right-of-use asset and a charge or credit to the restated consolidated statement of profit and loss depending upon the nature of modification. Where the carrying amount of the right-of-use asset is reduced to zero and there is a further reduction in the measurement of the lease liability, the Group recognises any remaining amount of the re-measurement in restated consolidated statement of profit and loss.

Lease payments associated with following leases are recognised as expense on straight-line basis: (i) low value leases; and (ii) leases which are short-term.

h. Financial instruments

i. Recognition and initial measurement

Trade receivables are initially recognised when they are originated. All other financial assets and liabilities are recognised when the Group becomes a party to the contractual provisions of the instrument. Financial assets and liabilities are initially measured at fair value. Transaction costs that are directly attributable to the acquisition or issue of financial assets and financial liabilities (other than financial assets and financial liabilities at fair value through profit or loss) are added to or deducted from the fair value measured on initial recognition of financial asset or financial liability.

A financial asset or financial liability is initially measured at fair value plus, for an item not at fair value through profit and loss (“FVTPL”), transaction costs that are directly attributable to its acquisition or issue.

ii. Classification and subsequent measurement

Financial assets

Cash and cash equivalents

Cash and cash equivalents includes cash on hand, other short-term highly liquid investments with original maturities of three months or less that are readily convertible to known amounts of cash and which are subject to an insignificant risk of changes in value.

Financial assets carried at amortised cost.

A financial asset is subsequently measured at amortised cost if it is held within a business model whose objective is to hold the asset in order to collect contractual cash flows and the contractual terms of the financial asset give rise on specified dates to cash flows that are solely payments of principal and interest on the principal amount outstanding.

Financial assets at fair value through other comprehensive income

A financial asset is subsequently measured at fair value through other comprehensive income (“FVOCI”) if it is held within a business model whose objective is achieved by both collecting contractual cash flows and selling financial assets and the contractual terms of the financial asset give rise on specified dates to cash flows that are solely payments of principal and interest on the principal amount outstanding.

Financial assets at fair value through profit or loss

A financial asset that is not classified in any of the above categories is subsequently fair valued through profit or loss (FVTPL). This include all derivative assets and current investments.

Financial liabilities

Financial liabilities at FVTPL are measured at fair value and net gains and losses, including any interest expense and are recognised in the restated consolidated statement of profit and loss. Other financial liabilities are subsequently carried at amortised cost using the effective interest method. Interest expense and foreign exchange gains and losses are recognised in profit or loss. Any gain or loss on derecognition is also recognised in profit or loss.

Derivative Instruments

The Group holds derivative financial instruments, such as foreign exchange forward contracts to mitigate the risk of changes in exchange rates on foreign currency exposures. The counterparty, for these contracts is generally a bank. These derivative instruments are recorded at fair value on every reporting date with changes being accounted in the restated consolidated statement of profit and loss.

iii. Derecognition

Financial assets

The Group derecognises a financial asset when the contractual rights to the cash flows from the financial asset expire, or it transfers the rights to receive the contractual cash flows in a transaction in which substantially all of the risks and rewards of ownership of the financial asset are transferred or in which the Group neither transfers nor retains substantially all of the risks and rewards of ownership and does not retain control of the financial asset.

Financial liabilities

The Group derecognises a financial liability when its contractual obligations are discharged or cancelled, or expire.

The Group also derecognises a financial liability when its terms are modified and the cash flows under the modified terms are substantially different. In this case, a new financial liability based on the modified terms is recognised at fair value. The difference between the carrying amount of the financial liability extinguished and the new financial liability with modified terms is recognised in the restated consolidated statement profit or loss.

i. Impairment

i. Impairment of financial instruments

The Group recognises loss allowances for expected credit losses (“ECL”) on financial assets measured at amortised cost.

At each reporting date, the Group assesses whether financial assets carried at amortised cost are credit impaired. A financial asset is ‘credit-impaired’ when one or more events that have a detrimental impact on the estimated future cash flows of the financial assets have occurred.

The Group follows ‘simplified approach’ for recognition of impairment loss allowance on trade receivables. The application of simplified approach does not require the Group to track changes in credit risk. Rather, it recognizes impairment loss allowance based on lifetime ECLs at each reporting date, right from its initial recognition. For recognition of impairment loss on other financial assets and risk exposure, the Group determines whether there has been a significant increase in the credit risk since initial recognition. If credit risk has not increased significantly, 12-month ECL is used to provide for impairment loss. However, if credit risk has increased significantly, lifetime ECL is used. If in subsequent period, credit quality of the instrument improves such that there is no longer a significant increase in credit risk since initial recognition, then the Group reverts to recognizing impairment loss allowance based on 12-month ECL.

ii. Impairment of non-financial assets

The Group’s non-financial assets, other than inventories and deferred tax assets, are evaluated for recoverability whenever events or changes in circumstances indicate that their carrying amounts may not be recoverable. For the purpose of impairment testing, the recoverable amount (i.e. the higher of the fair value less cost to sell and the value-in-use) is determined on an individual asset basis unless the asset does not generate cash flows that are largely independent of those from other assets. In such cases, the recoverable amount is determined for the Cash Generating Unit (“CGU”) to which the asset belongs.

If such assets are considered to be impaired, the impairment to be recognised in the restated consolidated statement of profit and loss is measured by the amount by which the carrying value of the assets exceeds the estimated recoverable amount of the asset.

An impairment loss in respect of goodwill is not subsequently reversed. In respect of assets for which impairment loss has been recognised in prior periods, the Group reviews at each reporting date whether there is any indication that the loss has decreased or no longer exists. An impairment loss is reversed in the restated consolidated statement of profit and loss if there has been a change in the estimates used to determine the recoverable amount.

The carrying amount of the asset is increased to its revised recoverable amount, provided that this amount does not exceed the carrying amount that would have been determined (net of any accumulated amortisation or depreciation) had no impairment loss been recognised for the asset in prior years.

j. Employee benefits

i. Defined benefit plan

Gratuity

The Group's gratuity plan is a defined benefit plan. The present value of obligation under such defined benefit plan is determined based on actuarial valuation carried out by an independent actuary using the projected unit credit method. The obligation is measured at the present value of estimated future cash flows. The discount rates used for determining the present value of obligation under defined benefit plan is based on the market yields on Government securities as at the reporting date, having maturity periods approximating to the terms of related obligations. Actuarial gains and losses are recognised immediately in the restated consolidated statement of assets and liabilities with a corresponding debit or credit to retained earnings through OCI in the period in which they occur.

Compensated absences

The employees of the Group are entitled to compensated absences. The employees can carry forward a portion of the unutilised accumulating compensated absence and utilise it in future periods or receive cash compensation at retirement or termination of employment. The Group records an obligation for compensated absences in the period in which the employee renders the services that increases this entitlement. The Group measures the expected cost of compensated absence as the additional amount that the Group expects to pay as a result of the unused entitlement that has accumulated at the reporting date. The calculation of the Group's obligation is performed annually by an independent actuary using the projected unit credit method as at the reporting date.

Non-accumulating compensated absences are recognised in the period in which the absences occur. The Group recognizes actuarial gains and losses immediately in the restated consolidated statement of profit and loss.

ii. Defined contribution plan

Provident fund

Provident fund is a post-employment benefit plan under which the Group makes specified monthly contribution towards Government administered provident fund scheme. Obligations for contributions to defined contribution plan are recognised as an employee benefit expense in the restated consolidated statement of profit and loss during the period in which the related services are rendered by the employees.

Share-based payment transactions

Employees of the Group receive remuneration in the form of equity settled instruments, for rendering services over a defined vesting period. Equity instruments granted are measured by reference to the fair value of the instrument at the date of grant. The expense is recognised in the restated consolidated statement of profit and loss with a corresponding increase in equity over the period that the employees unconditionally becomes entitled to the award. The equity instruments generally vest in a graded manner over the vesting period.

The fair value determined at the grant date is expensed over the vesting period of the respective tranches of such grants. The stock compensation expense is determined based on the Group's estimate of equity instruments that will eventually vest.

k. Taxes

Current income tax

Current income tax comprises the expected tax payable or receivable on the taxable income or loss for the year and any adjustment to the tax payable or receivable in respect of previous years. The amount of current income tax reflects the best estimate of the tax amount expected to be paid or received after considering the uncertainty, if any, related to income taxes. It is measured using tax rates (and tax laws) enacted or substantively enacted at the reporting date.

Current income tax relating to items recognised outside profit or loss is recognised outside profit or loss (either in other comprehensive income or in equity). Current tax items are recognised in correlation to the underlying transaction either in OCI or directly in equity. Management periodically evaluates positions taken in the tax returns with respect to situations in which applicable tax regulations are subject to interpretation and establishes provisions where appropriate.

Deferred income tax

Deferred tax is recognised in respect of temporary differences between the carrying amounts of assets and liabilities for financial reporting purposes and the amounts used for taxation purposes. Deferred tax is not recognised for temporary differences on the initial recognition of assets or liabilities in a transaction that is not a business combination and that affects neither accounting nor taxable profit or loss.

Deferred tax is measured at the tax rates that are expected to be applied to the temporary differences when they reverse, based on the laws that have been enacted or substantively enacted at the reporting date.

Deferred tax assets and liabilities are offset if there is a legally enforceable right to offset current tax liabilities and assets and they relate to taxes levied by the same tax authority on the same taxable entity.

A deferred tax asset is recognised for unused tax losses, tax credits and deductible temporary differences, to the extent that it is probable that future taxable profits will be available against which they can be utilised. Deferred tax assets are reviewed at each reporting date and are reduced to the extent that it is no longer probable that the related tax benefit will be realised.

Minimum alternate tax

Minimum alternate tax (“MAT”) credit is recognised as an asset only when and to the extent there is convincing evidence that the Group will pay normal income-tax during the specified period. In the year in which the MAT credit becomes eligible to be recognised as an asset, the said asset is created by way of a credit to the restated consolidated statement of profit and loss. The Group reviews the same at each reporting date and writes down the carrying amount of MAT credit entitlement, if any, to the extent there is no longer convincing evidence to the effect that the Group will pay normal income-tax during the specified period.

l. Earnings per share

The basic earnings per share is calculated by dividing the net profit for the year attributable to the owners of the Company by the weighted average number of equity shares outstanding during the year.

Diluted earnings per share is calculated by dividing the profit for the year attributable to the owners of the Company by the weighted average number of equity shares outstanding during the year, after adjustment for the effects of all dilutive potential equity shares.

m. Provisions and contingencies

A provision is recognised when an enterprise has a present obligation as a result of past events, it is probable that an outflow of resources will be required to settle the obligation and the amount can be reliably estimated. Provisions are determined by discounting the expected future cash flows to their present value and are determined based on best estimate required to settle the obligation at the reporting date. These are reviewed at each reporting date and adjusted to reflect the current best estimates. Provisions for onerous contracts, i.e. contracts where the expected unavoidable costs of meeting the obligations under the contract exceed the economic benefits expected to be received under it, are recognised when it is probable that an outflow of resources embodying economic benefits will be required to settle a present obligation as a result of an obligating event, based on a best estimate of such obligation.

Contingent liabilities are disclosed when there is a possible obligation arising from past events, the existence of which will be confirmed only by the occurrence or non-occurrence of one or more uncertain future events not wholly within the control of the Group or a present obligation that arises from past events where it is either not probable that an outflow of resources will be required to settle the obligation or a reliable estimate of the amount cannot be made. Contingent assets are neither recognised nor disclosed in the restated consolidated financial information.

n. Restated consolidated cash flow statement

Cash flows are reported using the indirect method, whereby net profit/(loss) before tax is adjusted for the effects of transactions of a non-cash nature, any deferrals or accruals of past or future operating cash receipts or payments and item of income or expenses associated with investing or financing cash flows. The cash flows from operating, investing and financing activities of the Group are segregated.

o. Segment reporting

Based on the “management approach” as defined in Ind AS 108 - Operating Segments, Managing Director of the Group has been identified as the Chief Operating Decision Maker (“CODM”). The CODM evaluates the Group's performance and allocates resources based on single segment approach and accordingly information has been presented.

Principal Adjustments Made in Restating our Audited Consolidated Financial Statements

For the principal adjustments we made in restating our audited consolidated financial statements, see “*Financial Statements – Note 55-Statement of Adjustments to the Restated Consolidated Statement*” on page 274.

Recent Accounting Pronouncements

On March 24, 2021, the Ministry of Corporate Affairs (MCA) through a notification, amended Schedule III of the Companies Act, 2013. The amendments revise Division I, II and III of Schedule III and are applicable from April 1, 2021. The Group is evaluating the effect of the amendments on its financial statements.

Description of Key Components of our Restated Consolidated Statement of Profit and Loss

Income

Our total income consists of revenue from operations and other income.

Revenue from Operations

Our revenue from operations is generated from (i) sale of products, (ii) sale of services, (iii) scrap sales, (iv) tooling income and (v) export incentive benefit.

Sale of Products

Within the automotive sector, we generate revenue from the sale of a range of precision forged and machined components and assemblies (such as connecting rod, rocker arm, crankshaft, gear shifter fork, stem comp, and aluminium forged parts) that are critical for engine, transmission, suspension, braking, chassis and other systems for the two-wheeler, passenger vehicle and commercial vehicle verticals. Within the non-automotive sector, we generate revenue from the sale of a range of precision components for the aerospace, off-road, agricultural and other segments, including engineering and capital goods.

Sale of Services

Our revenue from sale of services primarily includes revenues that we generate by providing machining operation services.

Scrap Sales

Our revenue from scrap sales includes from sale of items such as component scrap, forging scrap, boring scrap, end bits, lubricants, waste packing materials, used consumables, inserts, and items not fit to be used in equipment.

Tooling Income

Prior to placing a purchase contract, our customers undertake a selection process which includes multiple inspections and review of the prototypes. Our tooling income includes amounts paid to us by our customers for the development of such prototypes.

Export Incentive Benefit

Export incentive benefit consists of various incentives available for the export of goods under applicable schemes. For more details, see “*Risk Factors – Discontinuance or non-availability of fiscal benefits enjoyed by us or our inability to comply with related requirements may have an adverse effect on our business and results of operations*” on page 42.

Other Income

Our other income primarily consists of certain recurring items such as interest income from banks and others, net gain on foreign currency transactions (including on account of exchange rate difference, both realised and unrealised arising on receivables, payables and loans and cancellation of forward contracts) income from government grants, and certain non-recurring items, such as net profit on sale of property, plant and equipment.

Expenses

Our total expenses consist of (i) Cost of Materials, which comprises cost of materials consumed, changes in inventory of finished goods and work-in-progress, and conversion charges, (ii) consumption of stores and spares, (iii) power and fuel, (iv) employee benefit expenses, (v) finance costs, (vi) depreciation and amortisation expense and (vii) other expenses.

Cost of Materials

We define Cost of Materials as the sum of (i) cost of material consumed, (ii) change in inventories of finished goods and work in progress and (iii) conversion charges.

Cost of material consumed primarily consists of (i) the cost of raw materials that we consume in the manufacture of our products (our primary raw materials are alloy steel round bars and non-ferrous alloys, such as aluminium and titanium); and (ii) the cost of assembled components, such as roller bearings, screws, crank pins, bolts, bushes and sintered tips. Our cost of material consumed also includes costs of carriage inwards.

Change in inventories of finished goods and work in progress indicates the difference between our opening and closing inventory of finished goods and work-in-progress.

Conversion charges refer to the processing charges that we pay to third parties in respect of certain work outsourced, generally for conversion of raw material to forgings, chrome plating, diamond-like coating, machining, buffing and painting, among others.

Consumption of Stores and Spares

Consumption of stores and spares includes costs of cutting tools, stores consumables, maintenance spares, fixtures and gauges.

Power and Fuel

This consists of power and fuel costs for our operations.

Employee Benefit Expenses

Our employee benefit expenses comprise employee salaries and wages, gratuity expenses, contribution to provident and other funds, staff welfare expenses.

Finance Costs

Finance costs primarily consist of (i) interest cost on borrowings from (a) banks and (b) others, (ii) foreign exchange loss to the extent considered as borrowing cost and (iii) interest and finance charges on lease liabilities.

Depreciation and Amortisation Expense

Depreciation and amortisation expense consists of depreciation of tangible assets, including our building, plant and machinery, furniture, office equipment and vehicles, amortisation of intangible assets and depreciation on right of use of asset.

Other Expenses

Other expenses primarily comprise contract labour charges, freight outward, legal and professional charges, insurance, rates and taxes, CSR contribution and repairs and maintenance.

Tax Expenses

Tax expenses primarily comprise current and deferred taxes.

Our Results of Operations

The following table sets forth a summary of our restated consolidated statement of profit and loss for the fiscal years indicated:

Particulars	Fiscal 2021	Fiscal 2020	Fiscal 2019
	(₹ in million)		
Revenue:			
Revenue from operations	15,492.71	14,571.70	16,244.30
Other income	230.93	159.69	163.79
Total income	15,723.64	14,731.39	16,408.09
Expenses:			
Cost of material consumed	6,678.31	6,281.99	7,220.02
Changes in inventory of finished goods and work in progress	(43.71)	(18.95)	(167.01)
Conversion charges	526.15	486.79	468.80
Consumption of stores and spares	1,335.80	1,310.76	1,506.32
Power and fuel	670.65	750.55	841.31
Employee benefit expenses	2,137.50	2,134.24	2,174.07
Finance costs	473.93	580.90	512.81
Depreciation and amortisation expense	1,016.76	939.00	757.54
Other expenses	1,466.80	1,379.35	1,309.82
Total expenses	14,262.19	13,844.63	14,623.68
Profit before exceptional items and tax	1,461.45	886.76	1,784.41
Exceptional items	-	-	134.90
Profit before tax	1,461.45	886.76	1,649.51
Tax expenses:			
Current tax	303.87	235.05	492.55
Deferred tax (credit)/charge	58.98	(147.34)	176.32
Total tax expenses	362.85	87.71	668.87
Profit for the year	1,098.60	799.05	980.64

Fiscal 2021 Compared to Fiscal 2020

Revenue

Revenue from Operations

Set forth below is a table showing our revenue from operations for Fiscals 2021 and 2020.

Particulars	Fiscal 2021	Fiscal 2020	Percentage Increase/ (Decrease) (%)
	(₹ in million)		
Revenue from operations:			
Sale of products	14,568.90	13,930.38	4.58
Sale of services	2.30	13.02	(82.33)
Other operating revenue:			
Scrap sales	560.14	441.74	26.80
Tooling income	257.85	54.90	369.67
Export incentive benefit	103.52	131.66	(21.37)
Total	15,492.71	14,571.70	6.32

Our revenue from operations increased by 6.32% to ₹ 15,492.71 million for Fiscal 2021 from ₹ 14,571.70 million for Fiscal 2020. This increase was primarily due to increases in our sales of products, tooling income and scrap sales, which are discussed below.

Sale of Products

Our sale of products increased by 4.58% to ₹ 14,568.90 million for Fiscal 2021 from ₹ 13,930.38 million for Fiscal 2020. The primary reason for this was the increase in our revenue from sale of products from our new business (see table below). This was partially offset by the 6.55% decrease in our revenue from sale of products from our existing business (see table below) to ₹ 12,343.01 million for Fiscal 2021 from ₹ 13,208.60 million for Fiscal 2020. This decrease was primarily due to the decrease in vehicle production in India and globally. Due to challenges heaped by the COVID-19 pandemic, there

was a 12.6% decrease in the Indian two-wheeler industry's production in Fiscal 2021 and the production of passenger vehicles in India declined by approximately 11% in Fiscal 2021 (Source: the CRISIL Report, pages 25 and 50). The global Light Vehicle and CV segments registered a decline in production of 17.8% and 4.4%, respectively, for CY 2020 compared to CY 2019 due to COVID-19. (Source: the Ricardo Report, pages 5 and 17).

Particulars	Fiscal 2021	Fiscal 2020	Percentage Increase/ (Decrease) (%)
	(₹ in million)		
Revenue from existing business⁽¹⁾	12,343.01	13,208.60	-6.55%
Revenue from new business⁽²⁾:	2,225.89	721.78	208.39%
of which:			
Added in Fiscal 2021	298.50	-	N.C. ⁽³⁾
Added in Fiscal 2020	962.59	264.74	263.59%
Added in Fiscal 2019	964.80	457.03	111.10%
Revenue from sale of products	14,568.90	13,930.38	4.58%

Notes:

(1) Existing business means sales of existing products to existing customers.

(2) New business means sales of existing and new products to new customers and sales of new products to existing customers.

(3) N.C. means not comparable.

While production of vehicles fell in India and globally in Fiscal 2021, this trend is not expected to continue. The Indian two-wheeler industry's production is forecast by CRISIL Research to grow at a CAGR of 10.9% from Fiscal 2021 to Fiscal 2026. CRISIL Research estimates overall passenger vehicles production in India will grow at a CAGR of 10.8% from Fiscal 2021 to 2026. However, the risk of subsequent waves of COVID-19 cases and the localised or extended lockdowns to control the spread of the pandemic may have an impact on supply chains as well as sales. In such a case, overall industry production is also likely to be adversely affected over the short term. (Source: the CRISIL Report, page 36). Global Light Vehicles production is expected to grow at a CAGR of 5.4% from calendar years 2020 to 2025. Global CV production is expected to grow at a CAGR of 1.6% from calendar years 2020 to 2025, although a small dip is expected in calendar year 2021. (Source: the Ricardo Report, page 17).

Scrap Sales

Scrap sales increased by 26.80% to ₹ 560.14 million for Fiscal 2021 from ₹ 441.74 million for Fiscal 2020, primarily due to an increase in the usage of raw materials and higher average scrap realization rates.

Tooling Income

Tooling income increased by 369.67% to ₹ 257.85 million for Fiscal 2021 from ₹ 54.90 million for Fiscal 2020, primarily due to increased income booked in relation to the development of new products.

Other Income

Other income increased by 44.61% to ₹ 230.93 million for Fiscal 2021 from ₹ 159.69 million for Fiscal 2020, primarily due to an increase in income from government grants by 100.34% to ₹ 81.92 million for Fiscal 2021 from ₹ 40.89 million for Fiscal 2020.

Expenses

Cost of Materials: Set forth below is a table showing components of our Cost of Materials for Fiscals 2021 and 2020.

Particulars	Fiscal 2021	Fiscal 2020	Percentage Increase/ (Decrease) (%)
	(₹ in million)		
Cost of Materials:			
Cost of material consumed	6,678.31	6,281.99	6.31
Changes in inventory of finished goods and work in progress	(43.71)	(18.95)	N.C.*
Conversion charges	526.15	486.79	8.09
Total	7,160.75	6,749.83	6.09

*N.C. means not comparable.

Our Cost of Materials increased by 6.09% to ₹ 7,160.75 million for Fiscal 2021 from ₹ 6,749.83 million for Fiscal 2020. The percentage increase in Cost of Materials was in line with the 6.32% increase in our revenue from operations. Raw Materials Costs accounted for 46.22% and 46.32% of our revenue from operations in Fiscals 2021 and 2020, respectively.

Consumption of Stores and Spares

Our consumption of stores and spares increased by 1.91% to ₹ 1,335.80 million for Fiscal 2021 from ₹ 1,310.76 million for Fiscal 2020, primarily due to an increase in our production.

Power and Fuel

Our expenses on power and fuel decreased by 10.65% to ₹ 670.65 million for Fiscal 2021 from ₹ 750.55 million for Fiscal 2020. The decrease in power and fuel was primarily due to the sourcing of cheaper renewable power during Fiscal 2021.

Employee Benefit Expenses

Our employee benefit expenses increased by 0.15% to ₹ 2,137.50 million for Fiscal 2021 from ₹ 2,134.24 million for Fiscal 2020. During Fiscal 2021, there was no increment in salaries given to staff and salaries were reduced for a period of three months in response to the COVID-19 pandemic and related lockdowns. These factors were offset by the hiring of additional employees, with the number of our employees increasing by 5.25% to 3,868 as at March 31, 2021 from 3,675 as at March 31, 2020.

Finance Costs

Our finance costs decreased by 18.41% to ₹ 473.93 million for Fiscal 2021 from ₹ 580.90 million for Fiscal 2020. This decrease was due to a reduction in interest rates, an increase in the proportion of lower cost borrowings and a decrease in borrowings.

Depreciation and Amortisation Expense

Our depreciation and amortisation expense increased by 8.28% to ₹ 1,016.76 million for Fiscal 2021 from ₹ 939.00 million for Fiscal 2020, primarily due to an increase in capital expenditure incurred towards purchase of equipment.

Other Expenses

Our other expenses increased by 6.34% to ₹ 1,466.80 million for Fiscal 2021 from ₹ 1,379.35 million for Fiscal 2020. This increase was in line with the 6.74% increase in our total income in Fiscal 2021. Our other expenses increased primarily due to a 11.78% increase in our contract labour charges to ₹ 771.14 million for Fiscal 2021 from ₹ 689.87 million for Fiscal 2020, and a 46.36% increase in freight outward to ₹ 168.15 million for Fiscal 2021 from ₹ 114.89 million for Fiscal 2020. The increase in contract labour charges was due to payment of wages during the lock-down period and subsequent hiring of additional contract workmen due to an increase in production post lock-down. The number of contract workmen increased by 16.30% to 4,460 as at March 31, 2021 from 3,835 as at March 31, 2020. The increase in freight outward was due to the increase in freight charges and cost incurred to manage expedited deliveries with the surge in demand post the lock-down period. The total other expenses excluding contract labour charges and freight outward decreased by 8.19% to ₹ 527.51 million in Fiscal 2021 from ₹ 574.59 million in Fiscal 2020.

Tax Expenses

Our total tax expenses increased by 313.69% to ₹ 362.85 million for Fiscal 2021 from ₹ 87.71 million for Fiscal 2020. Our current tax increased by 29.28% to ₹ 303.87 million for Fiscal 2021 from ₹ 235.05 million for Fiscal 2020, which increase was primarily due to the 64.81% increase in profit before tax. Sansera Sweden had a profit before tax in Fiscal 2021 but did not have to pay taxes because of accumulated losses in previous years. We had a deferred tax charge of ₹ 58.98 million for Fiscal 2021 compared to a deferred tax credit of ₹ 147.34 million for Fiscal 2020. With effect from April 1, 2019, Section 115BAA was added to the Income Tax Act, 1961; this new section prescribed the concessional tax rates of 22% (with 10% of surcharge and 4% of cess) as against the erstwhile rates of 30% (with 12% of surcharge and 4% of cess). Our Company adopted the concessional tax rates, which resulted in the reversal of deferred tax amounting to ₹ 191.15 million in Fiscal 2020.

Profit for the Year

Primarily for the reasons stated above, our profit for the year increased by 37.49% to ₹ 1,098.60 million for Fiscal 2021 from ₹ 799.05 million for Fiscal 2020.

Fiscal 2020 Compared to Fiscal 2019

Revenue

Revenue from Operations

Set forth below is a table showing our revenue from operations for Fiscals 2020 and 2019.

Particulars	Fiscal 2020	Fiscal 2019	Percentage Increase/ (Decrease) (%)
	(₹ in million)		
Revenue from operations:			
Sale of products	13,930.38	15,269.81	(8.77)
Sale of services	13.02	125.00	(89.58)
Other operating revenue:			
Scrap sales	441.74	598.56	(26.20)
Tooling income	54.90	104.70	(47.56)
Export incentive benefit	131.66	146.23	(9.96)
Total	14,571.70	16,244.30	(10.30)

Our revenue from operations decreased by 10.30% to ₹ 14,571.70 million for Fiscal 2020 from ₹ 16,244.30 million for Fiscal 2019. This decrease was primarily due to decreases in sale of products, scrap sales and tooling income.

Sale of Products

Sale of products decreased by 8.77% to ₹ 13,930.38 million for Fiscal 2020 from ₹ 15,269.81 million for Fiscal 2019. The primary reason for this decrease was the 12.79% decrease in our revenue from sale of products from our existing business (see table below) to ₹ 13,208.60 million for Fiscal 2020 from ₹ 15,145.51 million for Fiscal 2019. The decrease in our revenue from sales of products from our existing business was partially offset by increase in our revenue from sale of products from our new business (see table below).

This decrease in our revenue from sale of products from our existing business was primarily due to a decrease in vehicle production in India and globally. There was a 14.1% decrease in production of two wheelers in India in Fiscal 2020 compared to Fiscal 2019 and production of passenger vehicles in India declined by 15% in Fiscal 2020 compared to Fiscal 2019 due to lower private consumption and inventory adjustment because of a change in emission norms from BS-IV to BS-VI, the liquidity crisis, and the onset of COVID-19. (Source: the CRISIL Report, page 50). Global Light Vehicles production declined by 22.5% in calendar year 2019 compared to calendar year 2018. (Source: the Ricardo Report, page 5).

Particulars	Fiscal 2020	Fiscal 2019	Percentage Increase/ (Decrease) (%)
	(₹ in million)		
Revenue from existing business ⁽¹⁾	13,208.60	15,145.51	(12.79)%
Revenue from new business ⁽²⁾	721.78	124.30	480.65%
<i>of which:</i>			
<i>Added in Fiscal 2020</i>	264.74	-	N.C. ⁽³⁾
<i>Added in Fiscal 2019</i>	457.03	124.30	267.67%
Revenue from sale of products	13,930.38	15,269.81	(8.77)%

Notes:

- (1) Existing business means sales of existing products to existing customers.
- (2) New business means sales of existing and new products to new customers and sales of new products to existing customers.
- (3) N.C. means not comparable.

Scrap Sales

Scrap sales decreased by 26.20% to ₹ 441.74 million for Fiscal 2020 from ₹ 598.56 million for Fiscal 2019, which decrease was primarily due to lower scrap realization rates and a decrease of 10.30% in our revenue from operations to ₹ 14,571.70 million for Fiscal 2020 from ₹ 16,244.30 million for Fiscal 2019.

Tooling Income

Tooling income decreased by 47.56% to ₹ 54.90 million for Fiscal 2020 from ₹ 104.70 million for Fiscal 2019, primarily due to lower income booked in relation to the development of new products.

Other Income

Other income decreased by 2.50% to ₹ 159.69 million for Fiscal 2020 from ₹ 163.79 million for Fiscal 2019.

Expenses

Cost of Materials: Set forth below is a table showing components of our Cost of Materials for Fiscals 2020 and 2019.

Particulars	Fiscal 2020	Fiscal 2019	Percentage Increase/ (Decrease) (%)
	(₹ in million)		
Cost of Materials:			
Cost of material consumed	6,281.99	7,220.02	(12.99)
Changes in inventory of finished goods and work in progress	(18.95)	(167.01)	N.C.*
Conversion charges	486.79	468.80	3.84
Total	6,749.83	7,521.81	(10.26)

* N.C. means not comparable.

Our Cost of Materials decreased by 10.26% to ₹ 6,749.83 million for Fiscal 2020 from ₹ 7,521.81 million for Fiscal 2019, in line with a decrease of 10.30% in our revenue from operations. Cost of Materials accounted for 46.32% and 46.30% of our revenue from operations for Fiscals 2020 and 2019, respectively.

Consumption of Stores and Spares

Our consumption of stores and spares decreased by 12.98% to ₹ 1,310.76 million for Fiscal 2020 from ₹ 1,506.32 million for Fiscal 2019, primarily due to the decrease in our revenue from operations.

Power and Fuel

Our expense on power and fuel decreased by 10.79% to ₹ 750.55 million for Fiscal 2020 from ₹ 841.31 million for Fiscal 2019, which was largely in line with the 10.30% decrease in revenue from operations.

Employee Benefit Expenses

Our employee benefit expenses decreased by 1.83% to ₹ 2,134.24 million for Fiscal 2020 from ₹ 2,174.07 million for Fiscal 2019. This decrease was primarily due to a decrease in the number of our employees. The number of our employees decreased by 4.30% to 3,675 as March 31, 2020 from 3,840 as March 31, 2019.

Finance Costs

Our total finance costs increased by 13.28% to ₹ 580.90 million in Fiscal 2020 from ₹ 512.81 million in Fiscal 2019. This increase was primarily due to an 11.04% increase in interest costs paid to banks and other financial institutions to ₹ 494.66 million for Fiscal 2020 from ₹ 445.47 million for Fiscal 2019, which was primarily due to an increase in borrowings.

Depreciation and Amortisation Expense

Our depreciation and amortisation expense increased by 23.95% to ₹ 939.00 million for Fiscal 2020 from ₹ 757.54 million for Fiscal 2019, primarily due to an increase in capital expenditure incurred towards purchase of equipment.

Other Expenses

Our other expenses increased by 5.31% to ₹ 1,379.35 million for Fiscal 2020 from ₹ 1,309.82 million for Fiscal 2019. This was primarily due to a 10.30% increase in our contract labour charges from ₹ 625.46 million for Fiscal 2019 to ₹ 689.87 million for Fiscal 2020, which increase was primarily due to an increased use of contract labour. The number of contract workmen increased by 12.83% to 3,835 as at March 31, 2020 from 3,399 as at March 31, 2019.

Exceptional Items

We recorded nil exceptional items in Fiscal 2020 compared to ₹ 134.90 million for Fiscal 2019, which was for one-time expenses for the relocation of manufacturing operations of Sansera Sweden to a new manufacturing facility.

Tax Expenses

Our total tax expenses decreased by 86.89% to ₹ 87.71 million for Fiscal 2020 from ₹ 668.87 million for Fiscal 2019. Our current tax decreased by 52.28% to ₹ 235.05 million for Fiscal 2020 from ₹ 492.55 million for Fiscal 2019, which decrease was primarily due to the 46.24% decrease in profit before tax, as well as a decrease in income tax rates for Fiscal 2020. We had a deferred tax credit of ₹ 147.34 million for Fiscal 2020 compared to a deferred tax charge of ₹ 176.32 million for Fiscal 2019. With effect from April 1, 2019, the new Section 115BAA was inserted in the Income Tax Act, 1961; this new section prescribed the concessional tax rates of 22% (with 10% of surcharge and 4% of cess) as against the erstwhile rates

of 30% (with 12% of surcharge and 4% of cess). Our Company adopted the concessional tax rates, which resulted in the reversal of deferred tax amounting to ₹ 191.15 million in Fiscal 2020.

Profit for the Year

Primarily for the reasons stated above, our profit for the year decreased by 18.52% to ₹ 799.05 million for Fiscal 2020 from ₹ 980.64 million for Fiscal 2019.

Financial Condition

Total Assets

The table below sets forth the principal components of our total assets as at March 31, 2021, March 31, 2020 and March 31, 2019 on a consolidated basis.

Particulars	As at March 31,		
	2021	2020	2019
	(₹ in million)		
Non-current assets:			
Property, plant and equipment	10,000.05	9,421.31	8,890.71
Capital work-in-progress	604.23	683.35	488.55
Goodwill	358.37	323.64	324.21
Other intangible asset	19.17	25.72	32.54
Right-of-use-asset	892.35	872.97	896.57
Financial assets:			
(i) Investments	36.93	36.93	-
(ii) Loan	284.54	267.10	257.32
(iii) Other financial assets	14.09	34.81	34.24
Tax assets for current taxes (net)	27.14	29.30	62.48
Other non-current assets	224.70	204.68	227.03
Total non-current assets	12,461.57	11,899.81	11,213.65
Current assets:			
Inventories	2,485.69	2,389.18	2,434.59
Financial assets:			
(i) Investments	5.58	3.53	5.34
(ii) Trade receivables	3,129.83	2,591.21	2,712.43
(iii) Cash and cash equivalents	365.00	600.08	239.27
(iv) Bank balances other than cash and cash equivalents	286.42	116.36	76.73
(v) Other financial assets	222.81	236.47	256.46
Other current assets	331.93	445.72	516.37
Total current assets	6,827.26	6,382.55	6,241.19
Total assets	19,288.83	18,282.36	17,454.84

Our total non-current assets were ₹ 11,213.65 million as at March 31, 2019, increased by 6.12% to ₹ 11,899.81 million as at March 31, 2020 and increased by 4.72% to ₹ 12,461.57 million as at March 31, 2021. The increase in our non-current assets was primarily due to increases in our property, plant and equipment, which increased from ₹ 8,890.71 million as at March 31, 2019 to ₹ 9,421.31 million as at March 31, 2020, primarily due to additions to plant and machinery, and further increased to ₹ 10,000.05 million as at March 31, 2021, primarily due to additions to plant and machinery.

Our trade receivables were ₹ 2,712.43 million as at March 31, 2019, decreased by 4.47% to ₹ 2,591.21 million as at March 31, 2020 and increased by 20.79% to ₹ 3,129.83 million as at March 31, 2021. The decrease as at March 31, 2020 was primarily due to a 10.30% decrease in our revenue from operations from Fiscal 2019 to Fiscal 2020, while the increase as at March 31, 2021 was primarily due to a 6.32% increase in our revenue from operations from Fiscal 2020 to Fiscal 2021.

Total Equity and Liabilities

The table below sets forth the principal components of our total equity and liabilities as at March 31, 2021, March 31, 2020 and March 31, 2019 on a consolidated basis.

Particulars	As at March 31,		
	2021	2020	2019
	(₹ in million)		
Equity			
Equity share capital	93.87	93.87	93.87
Instruments entirely equity in nature	105.00	105.00	105.00
Other equity	8,583.55	7,482.91	6,654.95
Total equity attributable to owners of the company	8,782.42	7,681.78	6,853.82
Non-controlling Interest	104.99	86.78	91.36
Total equity	8,887.41	7,768.56	6,945.18
Liabilities			
Non-Current Liabilities			
Financial liabilities:			
(i) Non-current borrowings	1,876.52	1,718.25	2,133.84
(ii) Lease liabilities	810.28	788.59	805.71
(iii) Other financial liability	-	11.04	76.87
Non-current provision	151.83	126.89	85.83
Deferred tax liabilities (net)	617.98	552.27	702.98
Other non-current liability	467.16	425.89	421.34
Total non-current liabilities	3,923.77	3,622.93	4,226.57
Current liabilities			
Financial Liabilities:			
(i) Current borrowings	2,552.32	3,554.12	3,043.08
(ii) Lease liabilities	110.88	96.94	86.48
(iii) Trade payables:			
- Total outstanding dues of micro enterprises and small enterprises	86.39	67.23	91.18
- Total outstanding dues of creditors other than micro enterprises and small enterprises	2,184.07	1,661.72	1,774.46
(iv) Other financial liabilities	1,236.67	1,218.31	1,002.36
Current tax liabilities (net)	0.59	29.52	82.51
Other current liabilities ⁽¹⁾	207.63	164.49	137.60
Current provisions	99.10	98.54	65.42
Total current liabilities	6,477.65	6,890.87	6,283.09
Total equity and liabilities	19,288.83	18,282.36	17,454.84

Note:

(1) Other current liabilities comprise advance from customers, statutory liability, and deferred government grant. Our statutory liability (primarily comprising indirect taxes, payroll related contributions and TDS) was ₹ 133.82 million, ₹ 110.38 million and ₹ 89.83 million as at March 31, 2021, March 31, 2020 and March 31, 2019, respectively.

Our total equity increased from ₹ 6,945.18 million as at March 31, 2019 to ₹ 7,768.56 million as at March 31, 2020 and increased to ₹ 8,887.41 million as at March 31, 2021. These increases were primarily due to increases in other equity, which increased from ₹ 6,654.95 million as at March 31, 2019 to ₹ 7,482.91 million as at March 31, 2020, primarily due to retained earnings, and further increased to ₹ 8,583.55 million as at March 31, 2021, primarily due to retained earnings.

Our total non-current liabilities decreased from ₹ 4,226.57 million as at March 31, 2019 to ₹ 3,622.93 million as at March 31, 2020 and increased to ₹ 3,923.77 million as at March 31, 2021. The decrease as at March 31, 2020 was primarily due to a decrease in non-current borrowings from ₹ 2,133.84 million as at March 31, 2019 to ₹ 1,718.25 million as at March 31, 2020 and a decrease in deferred tax liability from ₹ 702.98 million as at March 31, 2019 to ₹ 552.27 million as at March 31, 2020, which decrease was primarily due to the reduction in the income tax rate. With effect from April 1, 2019, the new Section 115BAA was inserted in the Income Tax Act, 1961; this section prescribed the concessional tax rates of 22% (with 10% of surcharge and 4% of cess) as against the erstwhile rates of 30% (with 12% of surcharge and 4% of cess). Our Company adopted the concessional tax rates, which resulted in the reversal of deferred tax amounting to ₹ 191.15 million in Fiscal 2020. The increase as at March 31, 2021 was primarily due to an increase in non-current borrowings from ₹ 1,718.25 million as at March 31, 2020 to ₹ 1,876.52 million as at March 31, 2021.

Our total current liabilities increased from ₹ 6,283.09 million as at March 31, 2019 to ₹ 6,890.87 million as at March 31, 2020 and decreased to ₹ 6,477.65 million as at March 31, 2021. These changes were primarily due to the changes in current

borrowings, which were partially offset, by among others, the changes in total outstanding dues to creditors other than micro enterprises and small enterprises.

Our current borrowings increased from ₹ 3,043.08 million as at March 31, 2019 to ₹ 3,554.12 million as at March 31, 2020, primarily due to current borrowings taken to create a surplus liquidity buffer with the onset of the COVID-19 pandemic, and decreased to ₹ 2,552.32 million as at March 31, 2021, primarily due to an increase in net cash generated from operating activities and lower capital expenditure.

Our total outstanding dues of creditors other than micro enterprises and small enterprises decreased from ₹ 1,774.46 million as at March 31, 2019 to ₹ 1,661.72 million as at March 31, 2020, primarily due to a decrease in Cost of Materials, and increased to ₹ 2,184.07 million as at March 31, 2021, primarily due to an increase in Cost of Materials.

Liquidity and Capital Resources

Our liquidity requirements primarily relate to capital expenditure and working capital. Our sources of liquidity for Fiscals 2021, 2020 and 2019 were cash generated from operating activities and borrowings from banks and financial institutions. We expect that our primary sources of liquidity will continue to be cash generated from operating activities and borrowings.

As at March 31, 2021, our cash and cash equivalents was ₹ 365.00 million.

Cash Flows

The following table sets forth a summary of our consolidated cash flows for the years indicated:

Particulars	Year ended March 31,		
	2021	2020	2019
	(₹ in million)		
Net cash generated from operating activities	2,560.35	2,412.10	2,184.54
Net cash used in investing activities	(1,394.66)	(1,770.88)	(2,376.06)
Net cash (used in)/generated from financing activities	(1,392.00)	(289.19)	144.73
Cash and cash equivalents at the beginning of the year	600.08	239.27	343.37
Effect of exchange differences on translation of foreign currency cash and cash equivalents	(8.77)	8.78	(55.95)
Net increase/(decrease) in cash and cash equivalents	(226.31)	352.03	(48.15)
Cash and cash equivalents at the end of the year	365.00	600.08	239.27

Operating Activities

Fiscal 2021

Net cash flow generated from our operating activities was ₹ 2,560.35 million for Fiscal 2021. Our profit before tax from continuing operations was ₹ 1,461.45 million, which was adjusted for non-cash and other items in a net amount of ₹ 1,375.44 million, resulting in an operating profit before working capital changes of ₹ 2,836.89 million. The key adjustments to operating cash flows included (i) an increase in inventory of ₹ 96.51 million, (ii) an increase in trade receivables of ₹ 442.92 million and (iii) an increase in trade payables and financial liabilities of ₹ 527.14 million.

Fiscal 2020

Net cash flow generated from our operating activities was ₹ 2,412.10 million for Fiscal 2020. Our profit before tax from continuing operations was ₹ 886.76 million, which was adjusted for non-cash and other items in a net amount of ₹ 1,522.65 million, resulting in an operating cash flows before working capital changes of ₹ 2,409.41 million. The key adjustments to operating cash flows included (i) a decrease in trade receivables of ₹ 206.27 million, and (ii) a decrease in trade payables and financial liabilities of ₹ 136.57 million.

Fiscal 2019

Net cash flow generated from our operating activities was ₹ 2,184.54 million for Fiscal 2019. Our profit before tax from continuing operations was ₹ 1,649.51 million, which was adjusted for non-cash and other items in a net amount of ₹ 1,266.58 million, resulting in an operating profit before working capital changes of ₹ 2,916.09 million. The key adjustments in operating cash flows included (i) an increase in inventory of ₹ 353.70 million, (ii) an increase in other liabilities and provisions of ₹ 112.49 million and (iii) an increase in other current and non-current assets and current financial assets of ₹ 55.44 million.

Investing Activities

Fiscal 2021

Net cash used in investing activities was ₹ 1,394.66 million during Fiscal 2021, which was primarily due to ₹ 1,351.21 million used for the purchase of property, plant and equipments. Capital expenditure in Fiscal 2021 was an addition of ₹ 1,269.00 million to plant and machinery.

Fiscal 2020

Net cash used in investing activities was ₹ 1,770.88 million during Fiscal 2020, which was primarily due to ₹ 1,767.17 million used for the purchase of property, plant and equipments.

Fiscal 2019

Net cash used in investing activities was ₹ 2,376.06 million during Fiscal 2019, which was primarily due to ₹ 2,381.33 million used for the purchase of property, plant and equipments.

Financing Activities

Fiscal 2021

Net cash used in financing activities was ₹ 1,392.00 million during Fiscal 2021, primarily owing to a net repayment of ₹ 992.26 million for our current borrowings, ₹ 459.00 million used for interest paid on our borrowings and ₹ 979.92 million used for the repayment of our non-current borrowings. This was offset by ₹ 1,099.93 million in proceeds generated from our non-current borrowings.

Fiscal 2020

Net cash used in financing activities was ₹ 289.19 million during Fiscal 2020, primarily owing to ₹ 951.69 million used for the repayment of our non-current borrowings and ₹ 580.90 million used for interest paid on our borrowings. This was partially offset by ₹ 809.50 million in proceeds generated from our non-current borrowings.

Fiscal 2019

Net cash generated from financing activities was ₹ 144.73 million during Fiscal 2019, primarily owing to ₹ 1,255.20 million in proceeds generated from our non-current borrowings and net proceeds from current borrowings of ₹ 148.80 million. This was partially offset by ₹ 710.20 million used for the repayment of non-current borrowings and ₹ 512.81 million used for interest paid on our borrowings.

Borrowings

As at March 31, 2021, we had total borrowings of ₹5,497.49 million, which consisted of non-current borrowings, current borrowings, current maturities of non-current borrowings and accrued interest.

Our loan agreements generally contain covenants, including limitations on the use of proceeds and restrictions on indebtedness, liens, asset sales, investments, transfer or ownership interests and certain changes in business. These covenants may limit our ability to pay dividends or make loans or advances to us, subject to the lender's waiver or consent. There were no defaults in repayment of principal or interest to lenders during Fiscals 2021, 2020 and 2019. See "*Risk Factors – Our financing agreements contain covenants that limit our flexibility in operating our business and there have been instances of non-compliance with covenants under financing agreements in the past*" on page 37.

The following table provides the types and amounts of our outstanding borrowings as at the dates indicated:

Particulars	As at March 31,		
	2021	2020	2019
	(₹ in million)		
Non-current borrowings	1,876.52	1,718.25	2,133.84
Current borrowings	2,552.32	3,554.12	3,043.08
Current maturities of non-current borrowings	1,053.72	1,095.40	776.71
Accrued interest	14.93	-	-
Total borrowings	5,497.49	6,367.77	5,953.63

We had borrowings with floating interest rates of ₹ 5,016.42 million, ₹ 5,893.90 million and ₹ 5,496.44 million as at March

31, 2021, 2020 and 2019, respectively. For further details of security, repayment terms and interest rates for our borrowings, see “Financial Statements – Note 57-Details of security, repayment terms and interest rate for non-current and current borrowings” on page 277.

Contractual Maturities of Financial Liabilities

The following table sets forth contractual maturities of financial liabilities as at March 31, 2021. The amounts are gross and undiscounted:

Particulars	Payment due by period			
	Total	Less than 1 year	1 -2 years	Above 2 years
	(₹ in million)			
Non-current borrowings (including current maturities)	2,930.24	1,053.72	808.73	1,067.79
Current borrowings	2,552.32	2,552.32	-	-
Trade payables	2,270.46	2,270.46	-	-
Other financial liabilities	182.95	182.95	-	-
Lease liabilities	921.16	110.88	107.49	702.79
Total	8,857.13	6,170.33	916.22	1,770.58

Capital Expenditure

The following table sets forth additions to property, plant and equipment by category of expenditure, for each of the years indicated below. These assets primarily relate to the expansion and maintenance of our manufacturing and engineering facilities.

Particulars	As at March 31,		
	2021	2020	2019
	(₹ in million)		
Lands	123.61	-	5.97
Buildings	30.93	210.65	273.22
Plant and machinery	1,269.00	1,094.85	2,368.89
Furniture and fixtures	0.80	2.93	4.37
Vehicles	4.63	5.81	29.29
Office equipment	8.03	3.30	11.70
Electrical installations	33.04	64.34	167.36
Computers	9.44	24.99	18.34
Leasehold improvements	4.81	1.31	202.01
Total	1,484.29	1,408.18	3,081.15

Planned Capital Expenditures

In Fiscal 2022, we plan to incur capital expenditures of approximately ₹ 2,500 million in India and Sweden, mostly for capacity expansion, including towards the construction of a new greenfield manufacturing facility in Bangalore dedicated to aerospace and defence and the setting up of new Fitwel Plant 3, as well as on general capital expenditure, such as IT and efficiency and productivity improvements. Our actual capital expenditures may differ from this estimate due to various factors, including changes to our business plan, the worsening of the COVID-19 pandemic, our financial performance, market conditions, our outlook for future business conditions, and changing governmental regulations.

Contingent Liabilities and Commitments

The following table sets our contingent liabilities and commitments as at March 31, 2021 as per the Restated Consolidated Financial Information:

Particulars	As at March 31, 2021 (₹ in million)
Contingent Liabilities[#]	
Claims against the Group not acknowledged as debts:	
Excise duty, entry tax and service tax matters ⁽¹⁾	80.35
Income tax matters ⁽¹⁾	11.98
Commitments^{##}	
Estimated amount of contracts remaining to be executed on capital account and not provided for ⁽²⁾	398.56

Notes:

- (1) Pending resolution of the respective proceedings, it is not practicable for the Group to estimate the timings of cash flows, in respect of the above as it is determinable only on receipt of judgment/decisions pending with various forums/authorities. The Group has reviewed all its pending litigations and proceedings and has adequately provided for wherever required and disclosed as contingent liabilities where applicable, in its restated consolidated financial information. The Group does not expect the outcome of these proceedings to have a materially adverse effect on its financial position.
 - (2) As at March 31, 2021, the Group has committed to spend ₹ 398.56 million under contracts to purchase property, plant and equipment.
- # The Supreme Court of India in the month of February 2019 had passed a judgement relating to definition of wages under the Provident Fund Act, 1952. However, considering that there are numerous interpretative issues relating to this judgement and in the absence of reliable measurement of the provision for the earlier periods, the Group had made a provision for provident fund contribution pursuant to the judgement in the previous year. The Group will evaluate its position and update its provision, if required, on receiving further clarity on the subject. The Group does not expect any material impact of the same.
- ## The Group has invested in Cleanmax Vega Power LLP (a power producer) and entered into an energy supply agreement in Fiscal 2020 for a period of 25 years with a lock in period of five years. Pursuant to such energy supply agreement, the Group has committed to purchase at least 51% of the total power produced by the power producer.

Off-balance Sheet Arrangements

We do not have any off-balance sheet arrangements or other relationships with any entity that have been established for the purposes of facilitating off-balance sheet arrangements.

Quantitative and Qualitative Disclosure on Market Risk

Market risk is the risk that the fair value of future cash flows of a financial instrument will fluctuate because of changes in market prices. Market prices comprises interest rate risk and currency rate risk. Financial instruments affected by market risk include loans, borrowings, receivables and payables. The Group's activities expose it to a variety of financial risks, including effects of changes in foreign currency exchange rates and interest rate movement.

Interest Rate Risk

Interest rate risk is the risk that the fair value or future cash flows of a financial instrument will fluctuate because of change in market interest rates. The Group's exposure to risk of changes in market interest rates relates primarily to the Group's non-current debt obligations with floating interest rates. For quantitative disclosures on interest rate risk, see "*Financial Statements – Note 45-Financial risk management – (v) Interest rate risk*" on page 267.

Foreign Currency Risk

The Group is exposed to currency risk on certain transactions that are denominated in a currency other than the Group's functional currency, which is the Rupee, hence exposures to exchange rate fluctuations arise. The risk is that the functional currency value of cash flows will vary as a result of movements in exchange rates. The Group uses forward exchange contracts to hedge its currency risk, most with a maturity of less than one year from the reporting date. For quantitative disclosures on foreign currency rate risk, see "*Financial Statements – Note 45-Financial Risk Management – (vi) Foreign currency risk*" on page 267.

Reservations, Qualifications and Adverse Remarks

There are no reservations, qualifications or adverse remarks in the audit reports relating to the Restated Consolidated Financial Information.

Unusual or Infrequent Events or Transactions

Other than as described in this section and "*Our Business*", "*Risk Factors*" and "*History and Certain Corporate Matters – Summary of Key Agreements*" on pages 147, 22 and 194, respectively, there have been no events or transactions which may be described as "unusual" or "infrequent".

Significant Economic Changes that Materially Affected or are likely to affect Revenue from Operations

Other than as described in this section, and in "*Our Business*", "*Risk Factors*" and "*Industry Overview*" on pages 147, 22 and 94, respectively, there have been no significant economic changes that materially affected or are likely to affect our revenue from continuing operations.

Known Trends or Uncertainties that have had or are expected to have a Material, Adverse Impact on Revenue from Operations or Other Income

In addition to the other factors and trends discussed in this section, we also expect that the domestic and global financial cycles will have a material impact on our financial condition and results of operations, as they impact the strength of the global economy and demand for automobiles, and consequently demand for our products.

Except as described in this section and "*Risk Factors*" on page 22, to our knowledge, there are no trends or uncertainties that

have had, or are expected to have, a material impact on our business or results of operations.

Future Relationships between Costs and Revenue

Other than as described in this section “*Our Business*” and “*Risk Factors*” on pages 147 and 22, respectively, there are no known factors which will have a material adverse impact on our operations or finances.

Material Increases in Revenues and Sales

Material increases in our revenues and sales are primarily due to the reasons described in “—*Our Results of Operations*” above on page 300.

New Product or Business Segments

Other than as described in this section and “*Our Business*” on page 147, there are no new products or business segments that are currently proposed to be developed or launched.

Seasonality

Our financial condition and results of operations may be affected by seasonal factors. See “*Risk Factors — Seasonal or economic cyclicity coupled with reduced demand in the verticals and sectors in which we operate may have a material adverse effect on our business, results of operations and financial condition*” on page 32.

Suppliers or Customer Concentration

Other than as described “*Our Business*” and “*Risk Factors — Our business is dependent on the sale of our products to certain key customers. The loss of any of these customers or loss of revenue from sales to these customers could have a material adverse effect on our business, financial condition, results of operations and cash flows*” on pages 147 and 24, respectively, we do not have any material dependence on a single or a few suppliers or customers.

Competitive Conditions

For a description of the competitive conditions in the industries in which we operate, see “*Our Business — Competition*” and “*Industry Overview – Competition scenario*” on pages 182 and 129, respectively.

Significant Developments after March 31, 2021

Except as set forth below and as disclosed elsewhere in this Red Herring Prospectus, our Company is not aware of any circumstances that have arisen since March 31, 2021 that have a material, adverse effect on, or are likely to affect, our operations or profitability, the value of our assets or our ability to pay our liabilities within the next 12 months.

Second Wave of the COVID-19 Pandemic in India

India seemed to have gotten COVID-19 cases under control, with the number of cases declining post September 2020. However, since the end of February 2021, India has been witnessing a second wave of COVID-19 cases, the number of daily active cases crossing the 400,000 mark for the first time in the first week of May, leading to state governments taking steps to control the spread including imposing curfews and lockdowns, resulting in loss of economic output. (*Source: the CRISIL Report, page 8*). This resulted in the temporary suspension of operations or reduced capacity at certain our manufacturing facilities in India. The table below sets forth the periods during which our manufacturing facilities were shut down or operated with reduced capacity due to the second wave of the COVID-19 pandemic.

Name of manufacturing facility	Period of shutdown (inclusive) / Days of shutdown ⁽¹⁾	Period of reduced capacity utilisation / Days of reduced capacity utilisation ⁽¹⁾
Plant 1, Plant 2, Plant 3, Plant 7, Plant 10, Plant 12 and Plant 14 ⁽²⁾	May 10, 2021 to May 11, 2021 / 2 days	Subsequently allowed to operate with only 50% workforce from May 12 to June 6, 2021 / 22 days
Plant 4	May 1, 2021 / 1 day	Not applicable
Plant 11	May 10, 2021 to May 13, 2021 / 4 days	Subsequently allowed to operate with only 50% workforce from May 14 to June 6, 2021 / 20 days
Plant 15	May 1, 2021 to May 14, 2021 / 12 days	Not applicable
Fitwel Plant 1 and Fitwel Plant 2	May 10, 2021 to May 12, 2021 / 3 days	Subsequently allowed to operate with only 50% workforce from May 13 to June 6, 2021 / 21 days

Notes:

(1) The number of days a plant was shut down for/had reduced capacity does not include Sundays and declared holidays.

(2) *Plant 8 was also shut down and subject to the same 50% workforce capacity cap but it is used for training, quality systems and new product development and not for manufacturing.*

The above shutdowns and reductions in capacity utilisation will have an adverse effect on our financial condition, results of operations and cash flows as at and for the year ending March 31, 2022 and any interim period therein beginning on April 1, 2021.

For information on the risks posed by the second wave of COVID-19 in India on our business, results of operations, financial condition and cash flows, see *“Risk Factors – The COVID-19 pandemic has had, and we expect it to continue to have, a material adverse effect on our business, financial condition, results of operations and cash flows”* on page 22.

Notification of Incentive Rates under the RODTEP Scheme on August 17, 2021

Prior to January 1, 2021, we were also eligible to avail the incentives under the Merchandise Exports from India Scheme (“**MEIS**”), pursuant to which, we could use duty credit scrips for payment of import duty obligations or sell such duty credit scrips in the open market to other importers. In the case of our export products, with our product mix, the average rate of MEIS was approximately 2% to 3% of FOB value of exports for Fiscal 2020. However, the Ministry of Finance, GoI has discontinued MEIS with effect from January 1, 2021 and announced a scheme for remission of duties and taxes on export products (“**RODTEP Scheme**”) for exporters, which is effective from January 1, 2021. The incentive rates under the RODTEP Scheme were notified on August 17, 2021. The incentive rates under the RODTEP Scheme for our products range from 1%-2% (subject to weight based capping for certain products), which are lower than the discontinued MEIS. The GoI has also announced the Production Linked Incentive Scheme (“**PLI Scheme**”) for various industries, including the automotive industry, which is yet to be notified by the GoI.

FINANCIAL INDEBTEDNESS

Our Company and Subsidiaries avail loans in the ordinary course of business for the purposes of meeting capital expenditure, working capital requirements and for general corporate purposes.

For details regarding the borrowing powers of our Board, please see “*Our Management – Borrowing Powers of Board*” on page 201.

Set forth below is a brief summary of our aggregate borrowings as of July 31, 2021:

Category of Borrowing	Total Sanctioned Amount (Fund Based and Non - Fund Based)	Fund Based Outstanding Amount	Non - Fund Based Outstanding Amount
<i>(in ₹ million)</i>			
Company			
Term Loan	6,214.87	2,787.06	-
Working Capital*	5,369.10	2,738.28	50.39
Total (A)	11,583.97	5,525.34	50.39
Fitwel			
Term Loan	236.33	123.73	
Working Capital*	325.00	232.40	1.04
Total (B)	561.33	356.13	1.04
SanseraMauritius			
Term Loan	-	-	-
Working Capital	-	-	-
Total (C)	-	-	-
Sansera Sweden			
Term Loan			
Working Capital**	537.98	363.70	138.88
Total (D)	537.98	363.70	138.88
Total (A)+(B)+(C)+(D)	12,683.28	6,245.16	190.31

*Working capital facilities includes cash credits, working capital demand loans, bills discounting facilities, packing credit facilities, Letter of Credits, Bank Guarantees, etc. This includes certain borrowings in foreign currency converted to INR based on FEDAI exchange rates as on July 30, 2021.

**Sansera Sweden AB has obtained following facilities in Sweden:

- (i) Short term credit facility from Citi Bank with the sanction limit to the tune of 3.40 million Euros converted into INR using exchange rate of Rs. 88.5200 (FEDAI Rate as on July 30, 2021). Outstanding balance in Euros as on July 31, 2021 is 3.00 million
- (ii) Short term credit from the Government of Sweden with respect to temporary tax-payment respite in connection with employer contributions, deducted tax and VAT. The outstanding balance in Swedish Krona as on July 31, 2021 is 11.31 million SEK converted into INR using exchange rate of Rs. 8.6800 (FEDAI Rate as on July 30, 2021).
- (iii) Bank Guarantee from Handelsbanken, Sweden of 16 million SEK as on July 31, 2021 converted into INR using exchange rate of Rs.8.6800 (FEDAI Rate as on July 30, 2021)

Principal terms of the borrowings availed by us from banks and financial institutions:

- 1. Interest:** The interest rates for the facilities availed by our Company and its Subsidiaries typically ranges from 1.50% per annum to 9.55% per annum. In terms of loans availed by the Company, the interest rate is either marginal cost of fund based lending rates (MCLR) of a specified lender and spread per annum or rates negotiated from time to time or rates which are mutually decided between the lender and the Company at the time of disbursement. The spread varies among different loans.
- 2. Tenor and Repayment:** The tenor and repayment of the facilities availed by our Company and Subsidiaries depends on the nature of facilities and agreement with the lenders. Working capital facilities are repayable on demand. The repayment terms of other facilities ranges from 90 days to 5.5 years as agreed with the lenders.
- 3. Security:** In terms of the borrowings where security needs to be created, the Company and Subsidiaries are typically required to:
 - a) Create a charge on current assets, including stock and book debt, both present and future;
 - b) Create a charge on movable and immovable fixed assets, both present and future;and
 - c) Provide a demand promissory note and letter of continuity.

This is an indicative list and there may be additional requirements for creation of security under the various borrowing arrangements entered into by us.

4. Events of Default: Borrowing arrangements entered into by us contains standard events of default, including:

- a) The borrower fails to pay any amount under the agreements on or before the due dates or commits breach of any of the terms of covenants or conditions contained in the agreement.
- b) If the borrower commits an act of insolvency or if the borrower is declared insolvent or bankrupt or if liquidator, receiver of official assignee is appointed in respect of any property or estate of the borrower or if the borrower makes an application for disclosing himself as insolvent or if an application for disclosing the borrower as insolvent is made or any order is passed by the competent court or authority for taking the borrower in to insolvency;
- c) Any mis-representations suppression of material records by the Borrower in respect of its assets and financial status.
- d) Failure to pay any tax impost, duty or other imposition or to comply with any other formalities required for the goods purchased with the facility under law from time to time;
- e) Breach of any of the terms, covenants, stipulations contained in the agreements;
- f) Any material change in the ownership or management of the business which in the opinion of lender would prejudice affect its interests, or the facility is used for purposes other than those stipulated in the Agreement; or
- g) Any defect, infirmity in the, guarantee provided by the guarantors which renders the guarantee ineffective, inoperative.
- h) A receiver is appointed over the whole or any part of the property of the borrower;
- i) Any order of attachment, distress, execution or other similar process is levied on any of the borrower's properties/assets.
- j) There exists any other circumstances which in the sole opinion of the lender prejudicially affects or may affect the lenders interest or the borrower's ability to repay the facility.

This is an indicative list and there may be additional terms and conditions that may amount to an event of default under various borrowing arrangements entered into by us. Our Company and Subsidiaries are required to ensure that the aforementioned events of default and other events of default, as specified under the various binding documents and agreements entered into by our Company and Subsidiaries, as the case maybe, for the purpose of availing of loans, are not triggered.

5. Restrictive Covenants: We are required to intimate the banks or obtain their prior written consent, as the case may be, in the event we intend to undertake the following:

- a) Affect any material change in the ownership/management of the business whereby the effective beneficial ownership or control of the borrower shall change, without the prior written consent of the bank.
- b) Enter into arrangement, agreement for sale, merger, consolidation, transfer, compromise, reconstruction without prior written consent of the lender.
- c) Create or permit the creation of any further charge, lien or other encumbrances on the securities provided under the agreement.
- d) The borrower acknowledges and accepts the right of the lender acting through its authorized personnel/ chartered accountant(s) to inspect its books of accounts, documents, records, stock in trade etc. The borrower agrees to extend its full co-operation and also covenants not to thwart or obstruct the entry upon its premises of any authorized person of lender for the purposes at inspection of the borrower's records and the goods purchased under the facility.
- e) The borrower covenants to use the facilities only for the purpose specified in the sanction letters/ agreements and agrees and acknowledges that any misuse of the facility shall amount to an event of default under the agreement.

- f) To make any amendments in the borrower's memorandum and articles without the prior written consent of the bank.
- g) To induct a person, into its board of directors, who is a promoter or director on the board of a company which has been identified as a wilful defaulter or a person who has been declared as a wilful defaulter by any bank/financial institution. In case such a person is already a member of the board of directors, the borrower would take expeditious and effective steps for the removal of that person from the board of directors.
- h) To declare any dividend if any instalment towards principal or interest remains unpaid on its due date.
- i) To create, assume or incur any further indebtedness of a long term nature whether for borrowed money or otherwise, except with the prior written consent of the bank.

This is an indicative list and there may be additional restrictive covenants that require prior intimation/prior consent of the banks.

- 6. Prepayment penalty/ prepayment charges:** The loans availed by the Company and Subsidiaries typically have prepayment provisions which allows for prepayment of the outstanding loan amount at any given point in time, subject to prepayment penalties as may be decided by the lender at the time of such prepayment. These pre-payment penalties typically range from 1% to 2% of the amount being prepaid. The prepayment penalty is as per the sanction terms.

SECTION VI: LEGAL AND OTHER INFORMATION

OUTSTANDING LITIGATION AND MATERIAL DEVELOPMENTS

*Except as disclosed in this section, there are no outstanding (i) criminal proceedings; (ii) action taken by regulatory or statutory authorities; (iii) claim related to direct and indirect taxes; and (iv) other pending litigation as determined to be material by our Board pursuant to the Materiality Policy passed by the Board of Directors, in each case involving our Company, Promoters, Directors and Subsidiaries (“**Relevant Parties**”). Further, except as disclosed in this section, there are (i) no disciplinary actions including penalties imposed by the SEBI or the stock exchanges against our Promoters in the last five Financial Years including any outstanding action; or (ii) pending litigation involving our Group Companies which may have a material impact on our Company.*

For the purpose of material litigation in (iv) above, our Board has considered and adopted the following policy on materiality with regard to outstanding litigation to be disclosed by our Company in this Red Herring Prospectus pursuant to Board resolution dated May 31, 2021:

*In terms of the Materiality Policy, all outstanding litigation involving the Relevant Parties, other than (I) outstanding criminal proceedings, outstanding actions by regulatory authorities and statutory authorities, and outstanding claims related to direct and indirect tax matters; and (II) disciplinary action including penalty imposed by SEBI or Stock Exchanges against the Promoters) in the last five Financial Years, would be considered ‘material’ if (i) the monetary amount of claim by or against the Relevant Party in any such pending proceeding is in excess of 1.00% of the profit after tax of the Company, as per the latest annual Restated Consolidated Financial Information included in the offer documents filed with the SEBI in connection with the proposed initial public offering of Equity Shares of the Company (“**Offer Documents**”); (ii) in the event that the monetary liability is not determinable or quantifiable, and in respect of matters where the monetary liability does not exceed an amount equivalent to or above or which does not exceed the threshold as specified in point (i) above, the outcome of any such pending proceedings may have a material bearing on the financial position, business, operations, performance, prospects or reputation of the Company. For the purposes of disclosure in this Red Herring Prospectus, it is clarified that the materiality threshold for all outstanding civil litigation involving the Relevant Parties is ₹10.99 million (“**Materiality Threshold**”), as per the Restated Consolidated Financial Information for the year ended March 31, 2021, and shall be updated, as per latest annual restated consolidated financial statements included in the Offer Documents.*

Except as stated in this section, there are no outstanding material dues to creditors of our Company. For this purpose, our Board has pursuant to board resolution dated May 31, 2021, considered and adopted a policy of materiality for identification of material outstanding dues to creditors. Further, in terms of the Materiality Policy, outstanding dues to any creditor of our Company having monetary value which exceeds 5.00% of the trade payables as at March 31, 2021, shall be considered ‘material’.

It is clarified that for the purposes of the above, pre-litigation notices from third parties (other than show cause notices issued by statutory/ regulatory/ tax authorities or notices threatening criminal action) received by our Company, Subsidiaries, Promoters or Directors shall, unless otherwise decided by our Board, not be deemed as material until such time that our Company, Subsidiaries, Promoters and/ or Directors, as the case may be, are impleaded as defendants in proceedings before any judicial/ arbitral forum.

Litigation involving our Company

Litigation against our Company

Civil Litigation

Nil

Criminal Litigation

Nil

Actions by regulatory/statutory authorities

1. The ESIC issued a notice dated August 29, 2006, for a contribution of ₹12.65 million, and directed our Company to produce records in relation to non payment of contribution regarding the labour element involved in expenditure towards “repair and maintenance” and “construction of the building” of Plant 2 and Plant 3 for the period between April 1999 to March 2005. Subsequently, an order dated July 29, 2008 was passed under Section 45-A of the Employees’ State Insurance Act, 1948 assessing the contribution to be made by our Company as ₹1.35 million. Our Company filed an ESI application

no. 34/2008 challenging the said order before the ESI Court. The ESI Court by an order dated February 29, 2016 allowed the application and modified the order, holding that contribution of ₹0.35 million was required to be paid by our Company. The Assistant Director, ESI Corporation, Regional Office (Karnataka) has filed an appeal before the High Court of Karnataka for challenging the said order. The matter is currently pending.

2. The Senior Assistant Director of Factories, Bangalore Division (“**Authority**”) issued a show cause notice dated September 25, 2017 to our Company in relation to a fire accident which took place at Plant 12 on August 13, 2017 involving two contract workers, who sustained burn injuries while checking the performance of the burner of the hot forging mechanical power press. Our Company filed a response to the show cause notice dated October 24, 2017 praying that the Authority take a lenient view. Our Company is yet to receive a response from the Authority.
3. The Haryana State Pollution Control Board (“**HSPCB**”) issued a notice dated March 12, 2021 in relation to non-compliance of the parameters laid down by the HSPCB for the discharge of nitrate. Our Company filed a response dated March 26, 2021 clarifying, *inter alia*, that our Company had adhered to all applicable norms, held a valid consent to operate for and is treating effluents in the manner prescribed by the HSPCB. Our Company remitted the performance security to HSPCB and prayed for a period of 90 days to upgrade the existing systems. An HSPCB appointed analyst conducted sample tests and issued a report dated August 17, 2021 (“**Report**”). Our Company has written a letter dated August 28, 2021 to the HSPCB submitting the Report and requesting release of performance security. We are yet to receive a response from HSPCB.
4. The Karnataka Industrial Areas Development Board (“**KIADB**”) issued a notice dated July 29, 2019 (“**Demand Notice**”) demanding an amount of ₹5.38 million to execute the sale deed for plot no. 143-B8(P) of Bommasandra 4th Phase (“**Scheduled Property**”), which was leased to our Company vide agreement to sell dated July 12, 2002. Our Company filed a writ petition dated June 29, 2020 before the High Court of Karnataka praying to quash the Demand Notice and to direct KIADB to execute the sale deed for the Scheduled Property. This matter is currently pending.
5. The Karnataka State Pollution Control Board (“**KSPCB**”) issued a demand order dated February 17, 2020 (“**Demand Order**”) to our Company, demanding an amount of ₹10.00 million on the grounds that Plant 12 was not compliant with the provisions of the Water (Prevention & Control of Pollution) Act, 1974, Air (Prevention & Control of Pollution) Act, 1981 and rules framed under Environment (Protection) Act, 1986 in relation to noise pollution and LPG storage. Our Company filed a reply dated February 27, 2020 refuting all allegations made pursuant to the Demand Order specifying that the Company is in compliance with all pollution regulations and laws and requesting for an opportunity to be heard in person. This matter is currently pending.
6. The Uttarakhand Pollution Control Board (“**UKPCB**”) issued a demand order dated March 12, 2020 (“**Demand Order**”) to our Company, demanding an amount of ₹10.00 million on the grounds that Plant 6 was not compliant with regulations in relation to discharge of pollutants, issued by the UKPCB and the order of the National Green Tribunal dated November 14, 2019 (“**NGT Order**”). Our Company filed a writ petition dated May 15, 2020 (“**Writ Petition**”) before the High Court of Uttarakhand to quash the Demand Order. The High Court of Uttarakhand pursuant to order dated May 18, 2020 read with order dated July 6, 2020 noted that the NGT Order has been stayed by the Supreme Court of India, and stayed recovery of the compensation demanded pursuant to the Demand Order until the Supreme Court of India completes adjudication in the matter related to the NGT Order. Further, the High Court of Uttarakhand has directed our Company to apprise the UKPCB of all measure undertaken to control pollutions. This matter is currently pending.

Litigation by our Company

Civil Litigation

Nil

Criminal Litigation

Nil

Litigation involving our Promoters

As on the date of this Red Herring Prospectus, there are no outstanding civil, criminal or tax litigations involving our Promoters. Further, no actions have been initiated against our Promoters by any regulatory/ statutory authorities and there are no disciplinary actions including penalties imposed by the SEBI or the stock exchanges against our Promoters in the last five Financial Years including any outstanding action.

Litigation involving our Directors

As on the date of this Red Herring Prospectus, there are no outstanding civil, criminal or tax litigations involving our Directors. Further, no actions have been initiated against our Directors by any regulatory/ statutory authorities.

Litigation involving our Subsidiaries above the materiality threshold

Nil

Litigation involving our Group Companies which may have a material impact on our Company

Nil

Tax Claims

Except as set out below, there are no claims related to direct and indirect taxes, involving our Company, Promoters, Directors, and Subsidiaries.

(₹ in million)		
Nature of case	Number of cases	Amount involved
Direct Tax		
Company	7	46.49
Subsidiaries	1	5.59
Indirect Tax		
Company	19	152.11
Subsidiaries	1	1.31
TOTAL	28	205.50

Description of tax matter exceeding the Materiality Threshold:

1. Our Company received a notice under 143(2) of the Income Tax Act, 1961 (“**IT Act**”) wherein assessment proceedings were initiated for assessment year 2014-15. Our Company filed written submissions post which, the Assistant Commissioner of Income Tax, Large Tax Payers Unit, Circle-1, Bangalore passed an assessment order dated December 13, 2016 (“**Assessment Order**”) wherein certain disallowances were undertaken to the returned income resulting in a disputed tax of ₹15.03 million. Further, the Assessment Order directed the income tax department to issue a separate penalty order to our Company for allegedly concealing its income. Our Company filed an appeal dated January 23, 2017 before the Commissioner of Income Tax (Appeals). This matter is currently pending.
2. The Office of the Principal Commissioner, Large Tax Payer Unit issued two orders dated May 15, 2017 and an order dated May 23, 2017 (“**Original Orders**”) wherein rebate claims amounting to ₹14.15 million (“**Rebate Claims**”) were rejected under Rule 18 of the Central Excise Rules, 2002. Aggrieved by the Original Orders, our Company filed three writ petitions dated September 20, 2017 before the High Court of Karnataka to quash the Original Orders, which were all dismissed by the High Court order pursuant to a common order dated November 22, 2019. Subsequently, our Company filed a writ appeal dated March 16, 2020 before the High Court of Karnataka (appellate jurisdiction) appealing on several grounds including, *inter alia*, that the Rebate Claims were not barred by time, the Office of the Principal Commissioner Large Tax Payer Unit passed the Original Orders without following principles of natural justice as no show cause notice were issued to our Company. The High court of Karnataka at Bengaluru through its order dated July 23, 2021 upheld the common order dated November 22, 2019.
3. Our Company received a show cause notice from the Directorate General of Goods and Services Tax Intelligence, Gurugram Zonal Unit in relation to short payment of central excise duty of ₹31.53 million (“**Demand**”) in connection with the valuation of goods supplied to a customer of our Company and the penalty which could be imposed under section 11AC of the Central Excise Act, 1944. Our Company has filed written submissions on January 15, 2020 before the Additional Director General (ADJN). This matter is currently pending.
4. Our Company received notice dated March 7, 2020 (“**Notice**”) from the Office of the commissioner of Customs Chennai IV in relation to recovery of an amount of ₹18.46 million being the amount of drawback sanctioned for non-realisation of export proceeds in accordance with the Customer, Central Excise Duties and Service Tax Drawback Rules, 1995. Our Company has filed written submission dated December 29, 2020 and have requested for the Notice

to be withdrawn as all essential conditions for drawback sanctioned have been fulfilled. This matter is currently pending.

5. The Additional Commissioner of Central Tax, Bengaluru South Commissionerate, passed an order dated March 29, 2019 (“**Demand Order**”) demanding an amount of ₹15.75 million (and an amount of ₹4.15 million as penalty) with respect to six show cause notices received by our Company dated February 4, 2013, December 23, 2013, November 20, 2014, November 30, 2015, May 19, 2017 and June 13, 2018 in connection with non-payment of service tax on labour charges remitted towards cavity milling undertaken by our Company from the period of April 2012 to June 2017. Our Company has filed an appeal dated May 21, 2019 before the Commissioner of Central Excise (Appeals) against the Demand Order on the grounds that the cavity milling activity undertaken by our Company amounts to manufacturing and therefore is not subject to service tax which was rejected by the Commissioner of Income Tax (Appeal – I), Bengaluru pursuant to order dated March 31, 2021, upholding the Demand Order. Our Company is in the process of filing an appeal. This matter is currently pending.
6. The Office of the Assistant Commissioner of Central Tax, South Division 8, Bangalore passed order dated May 17, 2018 and two orders dated May 18, 2018 (“**Original Orders**”) wherein rebate claims amounting to of ₹43.50 million (“**Rebate Claim**”) were rejected under Section 11B of Central Excise Act, 1944 read with Rule 18 of the Central Excise Rules, 2002. Aggrieved by the Original Order, our Company filed an appeal before the Commissioner of Central Tax (Appeal I) who remanded .it back to the original adjudicating authority for fresh proceedings pursuant to the order dated July 30, 2018. Subsequently, The Office of the Assistant Commissioner of Central Tax, South Division 8, Bangalore passed an order dated May 30, 2019 again rejecting the Rebate Claim. Our Company filed an appeal dated September 9, 2019 before the Commissioner (Appeals) appealing on several grounds including, *inter alia*, that the Rebate Claims were not barred by time. This matter is currently pending.

Outstanding litigations transferred from Gearock to our Company pursuant to the Scheme of Amalgamation

Georock merged into our Company, pursuant to the Scheme of amalgamation dated March 13, 2018 and the assets and liabilities of Gearock have now been transferred to our Company with effect from April 1, 2017

1. Gearock received an intimation under section 143(1) of the Income Tax Act, 1961 (“**IT Act**”) in relation to assessment year 2015-16, wherein an amount of Rs. 59.86 million was added to the returned income/loss resulting in a disputed tax demand of ₹12.60 million. Our Company has filed an appeal dated June 26, 2018 before the Commissioner of Income Tax (Appeals). This matter is currently pending.

Outstanding dues to Creditors

As of March 31, 2021, the total number of creditors of our Company and Subsidiaries was 1,836 and the total outstanding dues to these creditors by our Company and Subsidiaries was ₹2,004.78 million (excluding accrued employee salary, benefits and expenses). As of March 31, 2021, our Company and Subsidiaries owe an amount of ₹111.39 million (on a consolidated basis) to micro, small and medium enterprises.

As per the Materiality Policy, creditors of our Company to whom an amount having a monetary value which exceeds 5% of the ‘Trade Payables’ as on the date of the latest Restated Consolidated Financial Information as at March 31, 2021, shall be considered as ‘material’ i.e. creditors of our Company and Subsidiaries to whom our Company owes an amount exceeding ₹100.24 million. As of March 31, 2021, there were two material creditors to whom our Company and Subsidiaries owed an amount of ₹221.86 million.

Details of outstanding dues owed to MSMEs, material and other creditors as of March 31, 2021 are set out below:

Types of Creditors	Number of creditors	Amount involved (in ₹million)
MSMEs	174	111.39
Material creditors	2	221.86
Other creditors	1,660	1,671.53
Total Outstanding Dues	1,836	2,004.78

The details pertaining to the outstanding dues towards our material creditors as of March 31, 2021, along with the name and amount involved for each such material creditor, are available on the website of our Company at www.sansera.in/investor-quick-links/net-outstanding-dues-towards-our-material-creditors.pdf. It is clarified that such details available on our website do not form a part of this Red Herring Prospectus.

Material Developments

Other than as stated in “*Management’s Discussion and Analysis of Financial Condition and Results of Operations*” on page 282, there have not arisen, since the date of the last financial information disclosed in this Red Herring Prospectus, any circumstances which materially and adversely affect, or are likely to affect, our operations, our profitability taken as a whole or the value of our consolidated assets or our ability to pay our liabilities within the next 12 months.

GOVERNMENT AND OTHER APPROVALS

We have set out below an indicative list of approvals obtained by our Company which are considered material and necessary for the purpose of undertaking our business activities. In view of these key approvals, our Company can undertake this Offer, and can undertake its business activities. Other than as stated below, no further material approvals from any regulatory authority are required to undertake the Offer or continue such business activities. In addition, certain of our key approvals may have expired or may expire in the ordinary course of business, from time to time and our Company has either already made an application to the appropriate authorities for renewal of such key approvals or are in the process of making such renewal applications. In relation to the business activities and operations of our Company, we have disclosed below (i) approvals applied for but not received; and (ii) approvals that have expired and renewal to be applied for. For details in connection with the applicable regulatory and legal framework, see “Key Regulations and Policies” on page 184.

I. Incorporation Details of our Company

1. Certificate of incorporation dated December 15, 1981 issued by the RoC to our Company.
2. Certificate of incorporation dated June 29, 2018 issued by the RoC, consequent upon change in our name from Sansera Engineering Private Limited, to Sansera Engineering Limited, pursuant to conversion of our Company from a private limited company to a public limited company.
3. Our Company was allotted a corporate identity number U34103KA1981PLC004542.

II. Approvals in relation to the Offer

For details regarding the approvals and authorizations obtained by our Company in relation to the Offer, see “*Other Regulatory and Statutory Disclosures – Authority for the Offer*” on page 324.

III. Key approvals in relation to our business operations

Our Company is required to obtain various approvals and licenses under applicable laws, rules and regulations in order to operate our manufacturing plants situated in the states of Haryana, Gujarat, Karnataka, Maharashtra and Uttarakhand, details of which are set out below:

Plants of our Company

Plants situated in Karnataka

Our Company has obtained certain licenses and approvals in relation to our machining facilities (Plant 1, Plant 2 and Plant 3) situated at Gharvebhavipalya, Bengaluru, Bommasandra, Bengaluru and Jigani Link Road, Bengaluru, respectively, our machining and forging facilities (Plant 7 and Plant 11) situated at Jigani Link Road, Bengaluru and Bidadi, Karnataka, respectively; and our aerospace components manufacturing facility (Plant 9) situated at Jigani Link Road, Bengaluru which include, consent to establish and consent to operate from the state pollution control board under the Air Act, Water Act and Hazardous Waste Rules; licenses from the Inspector of Factories under the Factories Act, 1948 and certifications from the Chief Electrical Inspector under the Electricity Act, 2003 for electrical installation. In addition, one of our machining facilities (Plant 2) situated at Bommasandra Bengaluru has obtained a license to import and store petroleum by the Joint Chief Controller of Explosives under the Petroleum Act, 1934 and Petroleum Rules, 2002. Plant 2 has also obtained license from the Joint Chief Controller of Explosives under the Gas Cylinder Rules.

Further, we have obtained the required approvals and/or licenses include, among others, licenses from the Inspector of Factories under the Factories Act, 1948 in relation to our Registered and Corporate Office (Plant 7).

Our Company has been allotted an Importer – Exporter Code bearing #0794000649 issued by the Joint Director General of Foreign Trade, Ministry of Commerce and Industry, Government of India.

Plants situated outside Karnataka

Our Company has obtained certain licenses and approvals in relation to our machining facility situated in Manesar, Haryana (Plant 4) and Mehsana, Gujarat (Plant 15) and machining and forging facilities (Plant 5 and Plant 6) situated in Pune, Maharashtra and Panth Nagar, Uttarakhand, respectively, including, among others, consent to establish and consent to operate from the state pollution control board under the Air Act, Water Act and Hazardous Waste Rules, licenses from the Inspector of Factories under the Factories Act, 1948, certifications from the Chief Electrical Inspector

under the Electricity Act, 2003 for electrical installations and certified standing order issued under the Industrial Employment (Standing Orders) Act, 1946.

Plants transferred from Gearock to our Company pursuant to the Scheme of Amalgamation

In light of the merger of Gearock with our Company, pursuant to the Scheme of amalgamation dated March 13, 2018, the assets and liabilities of Gearock have now been transferred to our Company with effect from April 1, 2017. For information in relation to the scheme, see “*History and Corporate Matters - Details regarding material acquisitions or divestments of business/undertakings, mergers, amalgamation, or any revaluation of assets, in the last 10 years*” on page 192. Gearock has obtained the necessary approvals and/or licenses in relation to Plant 12 that include, among others, consent to establish and operate from the state pollution control board under the Air Act, Water Act and Hazardous Waste Rules and licenses from the Inspector of Factories under the Factories Act, 1948. Further, Gearock has received a certified standing order issued under the Industrial Employment (Standing Orders) Act, 1946. Gearock has obtained a consent to establish and operate from the state pollution control board under the Air Act, Water Act and Hazardous Waste Rules for Plant 14. The consent to establish and operate from the state pollution control board under the Air Act, Water Act and Hazardous Waste Rules is issued in the name of Gearock and will be renewed in the name of our Company.

IV. Key tax related registrations

Our Company and Fitwel are required to register themselves under various national tax laws and state specific tax laws. Our Company has obtained the necessary licenses and approvals from the appropriate regulatory and governing authorities in relation to such tax laws.

1. The permanent account number of our Company is AAECs2440M.
2. The tax deduction account number of our Company, as per the states where our business operation are spread, is as follows:

State	Tax deduction number
Gujarat	AHMS36300F
Haryana	RTKS09498G
Karnataka	BLRS14664G
Maharashtra	PNES14129D
Uttarakhand	MRTS05437F

3. The importer-exporter code of our Company is 794000649.
4. The goods and services tax registration number of our Company, as per the states where our business operation are spread, is as follows:

State	Registration Number
Gujarat	24AAECs2440M1ZD
Haryana	06AAECs2440M1ZB
Karnataka	29AAECs2440M1Z3
Maharashtra	27AAECs2440M1Z7
Uttarakhand	05AAECs2440M1ZD

V. Labour Related Approvals

1. We have obtained the relevant registrations under the Employees’ State Insurance Act, 1948, and the Contract Labour (Regulation and Abolition) Act, 1970. We have also been allotted a code under the Employees’ Provident Funds and Miscellaneous Provisions Act, 1952.
2. Our Company had entered into wage settlement agreements with trade unions for Plant 1, Plant 2, Plant 3, Plant 7 and Plant 12 situated in Karnataka and Plant 5 situated in Maharashtra.

VI. Pending Approvals

Approvals applied for but not received

1. Application dated December 30, 2020 made to the Karnataka State Pollution Control Board to amend the consent to establish for Plant 3.

Approvals expired and renewal to be applied for

1. Hazardous waste management authorization for Plant 3 situated in Karnataka. Our Company has submitted a letter dated June 9, 2020 to the Karnataka Pollution Control Board seeking extension in time to renew the authorization. This request is pending as on date.

VII. Intellectual Property Rights

Our Company has obtained registration for the trademark “SANSERA ideas@work” bearing number 3258270 under Class 12 dated May 12, 2016 which is valid for a period of ten years. Our Company has also obtained and renewed registration for the trademark “SANSERA” bearing number 545113 under Class 12 dated December 31, 1991 which is valid for a period of ten years from February 11, 2015.

OTHER REGULATORY AND STATUTORY DISCLOSURES

Authority for the Offer

Our Board has approved the Offer pursuant to the resolution passed at their meeting held on March 18, 2021 and our Shareholders have approved the Offer pursuant to a resolution passed at the AGM held on June 2, 2021. The Draft Red Herring Prospectus has been approved by our Board pursuant to a resolution passed on June 9, 2021. Our Board has approved this Red Herring Prospectus pursuant to its resolution dated September 6, 2021.

The Company had filed a draft red herring prospectus with SEBI and the Stock Exchanges on August 10, 2018 and received final observations bearing number CFD/DIL-II/AM/GB/3125/2018 on November 12, 2018 (the “**Final Observations**”). In terms of the Final Observations, the Company was permitted to open the offer for subscription within a period of 12 months from the date of the issuance of the Final Observations, i.e., November 11, 2019. However, the Company did not open the offer during the validity of the Final Observations because of unfavourable market conditions. The Company has initiated the IPO process again and has therefore filed the DRHP dated June 9, 2021, in relation to the Offer.

Each Selling Shareholder has, severally and not jointly, confirmed and approved its participation in the Offer for Sale in relation to its portion of the Offered Shares. For details, see “*The Offer*” on page 54.

Our Company has received in-principle approval from BSE and NSE for the listing of the Equity Shares pursuant to letters dated June 28, 2021 and July 8, 2021, respectively.

Prohibition by SEBI, RBI or other Governmental Authorities

Our Company, Promoters, Promoter Group, Directors, the Selling Shareholders, the persons in control of our Company are not prohibited from accessing the capital market or debarred from buying, selling or dealing in securities under any order or direction passed by the Board or any securities market regulator in any other jurisdiction or any other authority/court.

None of the companies with which our Promoters, Directors or persons in control of our Company are or were associated as promoter, directors or persons in control have been debarred from accessing capital markets under any order or direction passed by SEBI or any other authorities.

None of our Directors are associated with securities market related business, in any manner and there has been no outstanding actions initiated by SEBI against our Directors in the five years preceding the date of this Red Herring Prospectus.

Our Company, Promoters or Directors have not been declared as wilful defaulters by any bank or financial institution or consortium thereof in accordance with the guidelines on wilful defaulters issued by the RBI.

Our Promoters or Directors have not been declared as fugitive economic offenders.

Confirmation under Companies (Significant Beneficial Owners) Rules, 2018

Our Company, Selling Shareholders, Promoters and members of Promoter Group are in compliance with the Companies (Significant Beneficial Ownership) Rules, 2018, to the extent applicable, as on the date of this Red Herring Prospectus.

Eligibility for the Offer

Our Company is eligible for the Offer in accordance with the Regulation 6(1) of the SEBI ICDR Regulations, and is in compliance with the conditions specified therein in the following manner:

- Our Company has had net tangible assets of at least ₹30 million, calculated on a restated basis, in each of the preceding three full financial years (of 12 months each), i.e., as on and for the financial years ended March 31, 2021, March 31, 2020 and March 31, 2019. As the Offer is being made entirely through an offer for sale, the limit of not more than 50% of the net tangible assets being monetary assets, is not applicable;
- Our Company has an average pre-tax operating profit of at least ₹150 million, calculated on a restated basis, during the preceding three full financial years (of 12 months each), i.e., as on and for the financial years ended March 31, 2021, March 31, 2020 and March 31, 2019, with pre-tax operating profit in each of these preceding three years;
- Our Company has a net worth of at least ₹10 million, calculated on a restated basis, in each of the preceding three full years (of 12 months each), i.e., as on and for the financial years ended March 31, 2021, March 31, 2020 and March 31, 2019; and
- Our Company has not changed its name in the last one year.

Our Company's operating profit, net worth and net tangible assets derived from the Restated Consolidated Financial Information included in this Red Herring Prospectus as at, and for the financial years ended March 31, 2021, March 31, 2020 and March 31, 2019 are set forth below:

(₹ in million)

S. No.	Particulars	Fiscal 2021	Fiscal 2020	Fiscal 2019
A.	Net tangible assets, as restated ⁽¹⁾	9,156.66	7,984.03	7,287.03
B.	Monetary assets, as restated ⁽²⁾	651.42	716.44	316.00
C.	Monetary assets, as restated, as a percentage of net tangible assets, as restated (B/A)	7.11%	8.97%	4.34%
D.	Net worth, as restated ⁽³⁾	8,774.25	7,673.61	6,845.65
E.	Operating profits, as restated ⁽⁴⁾	1,704.45	1,307.97	2,133.43

Notes:

- (1) Net tangible assets are defined as sum of total assets excluding goodwill, other intangible assets and right of use assets deducted by sum of total non-current liabilities and total current liabilities excluding related non-current and current lease liabilities and deferred tax liabilities (net), as per the Restated Consolidated Financial Information.
- (2) Monetary asset includes Cash and Cash Equivalents comprising of Cash on hand & Balances with banks in current accounts and Bank balances other than cash and cash equivalents comprising of deposit accounts (due to mature within 12 months from the reporting date) which includes certain deposits pledged against bank guarantees and letter of credits provided by the bank as per the Restated Consolidated Financial Information.
- (3) Net worth means the aggregate value of the paid-up share capital and all reserves created out of the profits and securities premium account and debit or credit balance of profit and loss account, after deducting the aggregate value of the accumulated losses, deferred expenditure and miscellaneous expenditure not written off, as per the audited balance sheet, but does not include reserves created out of revaluation of assets, write-back of depreciation and amalgamation
- (4) Operating profit has been calculated as a restated profit before tax excluding, exceptional items, finance cost and other income, as per the Restated Consolidated Financial Information.

Our Company is in compliance with the conditions specified in Regulation 5 of the SEBI ICDR Regulations, to the extent applicable. Our Company confirms that it is also in compliance with the conditions specified in Regulation 7(1) of the SEBI ICDR Regulations, to the extent applicable, and will ensure compliance with the conditions specified in Regulation 7(2) of the SEBI ICDR Regulations, to the extent applicable.

Our Company shall not make an Allotment if the number or prospective allottees is less than 1,000 in accordance with Regulation 49(1) of the SEBI ICDR Regulations.

The Selling Shareholders confirm that the Equity Shares offered by each Selling Shareholder as part of the Offer for Sale have been held in compliance with Regulation 8 of the SEBI ICDR Regulations.

DISCLAIMER CLAUSE OF SEBI

IT IS TO BE DISTINCTLY UNDERSTOOD THAT SUBMISSION OF THE DRAFT RED HERRING PROSPECTUS TO SEBI SHOULD NOT IN ANY WAY BE DEEMED OR CONSTRUED THAT THE SAME HAS BEEN CLEARED OR APPROVED BY SEBI. SEBI DOES NOT TAKE ANY RESPONSIBILITY EITHER FOR THE FINANCIAL SOUNDNESS OF ANY SCHEME OR THE PROJECT FOR WHICH THE OFFER IS PROPOSED TO BE MADE OR FOR THE CORRECTNESS OF THE STATEMENTS MADE OR OPINIONS EXPRESSED IN THE DRAFT RED HERRING PROSPECTUS. THE BRLMS HAVE CERTIFIED THAT THE DISCLOSURES MADE IN THE DRAFT RED HERRING PROSPECTUS ARE GENERALLY ADEQUATE AND ARE IN CONFORMITY WITH THE SEBI ICDR REGULATIONS. THIS REQUIREMENT IS TO FACILITATE INVESTORS TO TAKE AN INFORMED DECISION FOR MAKING AN INVESTMENT IN THE PROPOSED OFFER.

IT SHOULD ALSO BE CLEARLY UNDERSTOOD THAT WHILE THE COMPANY IS PRIMARILY RESPONSIBLE FOR THE CORRECTNESS, ADEQUACY AND DISCLOSURE OF ALL RELEVANT INFORMATION IN THE DRAFT RED HERRING PROSPECTUS, THE BRLMs ARE EXPECTED TO EXERCISE DUE DILIGENCE TO ENSURE THAT THE COMPANY DISCHARGES ITS RESPONSIBILITY ADEQUATELY IN THIS BEHALF AND TOWARDS THIS PURPOSE, THE BRLMs HAVE FURNISHED TO SEBI A DUE DILIGENCE CERTIFICATE DATED JUNE 9, 2021 IN ACCORDANCE WITH SEBI (MERCHANT BANKERS) REGULATIONS, 1992, IN THE FORMAT PRESCRIBED UNDER SCHEDULE V (FORM A) OF THE SEBI ICDR REGULATIONS.

THE FILING OF THE DRAFT RED HERRING PROSPECTUS DOES NOT, HOWEVER, ABSOLVE THE COMPANY FROM ANY LIABILITIES UNDER THE COMPANIES ACT, 2013 OR FROM THE REQUIREMENT OF OBTAINING SUCH STATUTORY OR OTHER CLEARANCES AS MAY BE REQUIRED FOR THE PURPOSE OF THE PROPOSED OFFER. SEBI FURTHER RESERVES THE RIGHT TO TAKE UP, AT ANY POINT OF TIME, WITH THE BRLMs ANY IRREGULARITIES OR LAPSES IN THE DRAFT RED HERRING PROSPECTUS.

All legal requirements pertaining to this Offer will be complied with at the time of filing of this Red Herring Prospectus with the RoC in terms of Section 32 of the Companies Act. All legal requirements pertaining to this Offer will be complied with at the time of filing of the Prospectus with the RoC in terms of Sections 26, 32, 33(1) and 33(2) of the Companies Act.

Disclaimer from our Company, our Directors and BRLMs

Our Company, our Directors and the BRLMs accept no responsibility for statements made otherwise than in this Red Herring Prospectus or in the advertisements or any other material issued by or at our Company's instance and anyone placing reliance on any other source of information, including our Company's website www.sanseraindia.com, or the respective websites of our Promoters, Promoter Group or any affiliate of our Company would be doing so at his or her own risk.

The BRLMs accept no responsibility, save to the limited extent as provided in the Offer Agreement and the Underwriting Agreement.

All information shall be made available by our Company, and the BRLMs to the Bidders and the public at large and no selective or additional information would be made available for a section of the investors in any manner whatsoever, including at road show presentations, in research or sales reports, at the Bidding Centres or elsewhere.

Bidders will be required to confirm and will be deemed to have represented to our Company, the Underwriters and their respective directors, officers, agents, affiliates, and representatives that they are eligible under all applicable laws, rules, regulations, guidelines and approvals to acquire the Equity Shares and will not sell, pledge, or transfer the Equity Shares to any person who is not eligible under any applicable laws, rules, regulations, guidelines and approvals to acquire the Equity Shares. Our Company, the Underwriters and their respective directors, officers, agents, affiliates, and representatives accept no responsibility or liability for advising any investor on whether such investor is eligible to acquire the Equity Shares.

The BRLMs and their respective associates and affiliates in their capacity as principals or agents may engage in transactions with, and perform services for, our Company, Promoters, the Selling Shareholders, their respective directors and officers, group companies, affiliates or associates or third parties in the ordinary course of business and have engaged, or may in the future engage, in commercial banking and investment banking transactions with our Company, the Promoters, and their respective directors, officers, agents, group companies, affiliates or associates or third parties, for which they have received, and may in the future receive, compensation.

Disclaimer from our Selling Shareholders

Our Selling Shareholders accept no responsibility for statements made otherwise than in this Red Herring Prospectus or in the advertisements or any other material issued by or at our Company's instance and anyone placing reliance on any other source of information, including our Company's website www.sanseraindia.com, or the respective websites of our Promoters, Promoter Group or any affiliate of our Company would be doing so at his or her own risk. Each of the Selling Shareholder, its respective directors, affiliates, associates, and officers accept no responsibility for any statements made in this Red Herring Prospectus other than those specifically made or confirmed by such Selling Shareholder in relation to itself as a Selling Shareholder and its proportion of the Offered Shares. Each of the Selling Shareholders, severally and not jointly, assumes no responsibility for any other statements, made by or relating to our Company or its business in this Red Herring Prospectus. Bidders will be required to confirm and will be deemed to have represented to the Selling Shareholders and their respective directors, officers, agents, affiliates, and representatives that they are eligible under all applicable laws, rules, regulations, guidelines and approvals to acquire the Equity Shares and will not sell, pledge, or transfer the Equity Shares to any person who is not eligible under any applicable laws, rules, regulations, guidelines and approvals to acquire the Equity Shares. The Selling Shareholders and their respective directors, officers, agents, affiliates, and representatives accept no responsibility or liability for advising any investor on whether such investor is eligible to acquire the Equity Shares.

Disclaimer in respect of Jurisdiction

This Offer is being made in India to persons resident in India (who are competent to contract under the Indian Contract Act, 1872, including Indian nationals resident in India, HUFs, companies, other corporate bodies and societies registered under the applicable laws in India and authorised to invest in shares, domestic Mutual Funds, Indian financial institutions, commercial banks, regional rural banks, co-operative banks (subject to RBI permission), or trusts under applicable trust law and who are authorised under their constitution to hold and invest in equity shares, state industrial development corporations, insurance companies registered with IRDAI, provident funds (subject to applicable law) and pension funds, National Investment Fund, insurance funds set up and managed by army, navy or air force of Union of India, insurance funds set up and managed by the Department of Posts, GoI, systemically important NBFCs registered with the RBI) and permitted Non-Residents including FPIs and Eligible NRIs and AIFs that they are eligible under all applicable laws and regulations to purchase the Equity Shares.

This Red Herring Prospectus does not constitute an offer to sell or an invitation to subscribe to Equity Shares offered hereby, in any jurisdiction to any person to whom it is unlawful to make an offer or invitation in such jurisdiction. Any person into whose possession this Red Herring Prospectus comes is required to inform him or herself about, and to observe, any such

restrictions. Any dispute arising out of this Offer will be subject to the jurisdiction of appropriate court(s) in Mumbai, Maharashtra, India only.

Neither the delivery of this Red Herring Prospectus nor the Offer of the Offered Shares shall, under any circumstances, create any implication that there has been no change in the affairs of our Company or any of the Selling Shareholders since the date of this Red Herring Prospectus or that the information contained herein is correct as of any time subsequent to this date.

Selling and Transfer Restrictions

The Offered Shares offered in the Offer have not been and will not be registered, listed or otherwise qualified in any jurisdiction except India and may not be offered or sold to persons outside of India except in compliance with the applicable laws of each such jurisdiction.

This Red Herring Prospectus does not constitute an invitation to subscribe to or purchase the Offered Shares in the Offer in any jurisdiction, including India. Invitations to subscribe to or purchase the Equity Shares in the Offer will be made only pursuant to the Red Herring Prospectus if the recipient is in India or the preliminary offering memorandum for the Offer, which comprises the Red Herring Prospectus and the preliminary international wrap for the Offer, if the recipient is outside India.

No person outside India is eligible to Bid for Equity Shares in the Offer unless that person has received the preliminary offering memorandum for the Offer, which contains the selling restrictions for the Offer outside India.

The Offered Shares offered in the Offer have not been and will not be registered under the U.S. Securities Act of 1933, as amended (the “**U.S. Securities Act**”) or the laws of any state of the United States and may not be offered or sold in the United States, except pursuant to an exemption from, or in a transaction not subject to, the registration requirements of the U.S. Securities Act and applicable state securities laws. The Offered Shares are being offered and sold only (i) outside the United States in offshore transactions in reliance on Regulation S under the U.S. Securities Act (“**Regulation S**”); and (ii) in the United States to persons reasonably believed to be “qualified institutional buyers” (as defined in Rule 144A (“**Rule 144A**”) under the U.S. Securities Act), pursuant to Rule 144A or another available exemption from the registration requirements of the U.S. Securities Act.

Until the expiry of 40 days after the commencement of the Offer, an offer or sale of the Offered Shares in the United States by a dealer (whether or not it is participating in the Offer) may violate the registration requirements of the U.S. Securities Act unless made pursuant to Rule 144A or another available exemption from the registration requirements of the U.S. Securities Act and in accordance with applicable state securities laws in the United States

Each purchaser of the Offered Shares in the Offer in India shall be deemed to:

- Represent and warrant to our Company, the Selling Shareholders, the BRLMs and the Syndicate Members that it was outside the United States (as defined in Regulation S) at the time the offer of the Offered Shares was made to it and it was outside the United States (as defined in Regulation S) when its buy order for the Offered Shares was originated.
- Represent and warrant to our Company, the Selling Shareholders, the BRLMs and the Syndicate Members that it did not purchase the Offered Shares as a result of any “directed selling efforts” (as defined in Regulation S).
- Represent and warrant to our Company, the Selling Shareholders, the BRLMs and the Syndicate Members that it bought the Offered Shares for investment purposes and not with a view to the distribution thereof. If in the future it decides to resell or otherwise transfer any of the Equity Shares, it agrees that it will not offer, sell or otherwise transfer the Offered Shares except in a transaction complying with Rule 903 or Rule 904 of Regulation S or pursuant to any available exemption from registration under the U.S. Securities Act.
- Represent and warrant to our Company, the Selling Shareholders, the BRLMs and the Syndicate Members that if it acquired any of the Offered Shares as fiduciary or agent for one or more investor accounts, it has sole investment discretion with respect to each such account and that it has full power to make the foregoing representations, warranties, acknowledgements and agreements on behalf of each such account.
- Represents and warrant to our Company, the Selling Shareholders, the BRLMs and the Syndicate Members that if it acquired any of the Offered Shares for one or more managed accounts, that it was authorized in writing by each such managed account to subscribe to the Offered Shares for each managed account and to make (and it hereby makes) the representations, warranties, acknowledgements and agreements herein for and on behalf of each such account, reading the reference to “it” to include such accounts.
- Agree to indemnify and hold the Company, the Selling Shareholders, the BRLMs and the Syndicate Members harmless from any and all costs, claims, liabilities and expenses (including legal fees and expenses) arising out of or in connection

with any breach of these representations, warranties or agreements. It agrees that the indemnity set forth in this paragraph shall survive the resale of the Offered Shares.

- Acknowledge that our Company, the Selling Shareholders, the BRLMs, the Syndicate Members and others will rely upon the truth and accuracy of the foregoing representations, warranties, acknowledgements and agreements.

As required, a copy of this Red Herring Prospectus shall be submitted to BSE. The disclaimer clause as intimated by BSE to our Company, post scrutiny of this Red Herring Prospectus, are included in this Red Herring Prospectus prior to the RoC filing.

Disclaimer Clause of the NSE

As required, a copy of this Offer Document has been submitted to National Stock Exchange of India Limited (hereinafter referred to as NSE). NSE has given vide its letter Ref.: NSE/LIST/1072 dated July 08, 2021 permission to the Issuer to use the Exchange's name in this Offer Document as one of the Stock Exchanges on which this Issuer's securities are proposed to be listed. The Exchange has scrutinized this draft offer document for its limited internal purpose of deciding on the matter of granting the aforesaid permission to this Issuer. It is to be distinctly understood that the aforesaid permission given by NSE should not in any way be deemed or construed that the offer document has been cleared or approved by NSE; nor does it in any manner warrant, certify or endorse the correctness or completeness of any of the contents of this Offer Document; nor does it warrant that this Issuer's securities will be listed or will continue to be listed on the Exchange; nor does it take any responsibility for the financial or other soundness of this Issuer, its promoters, its management or any scheme or project of this Issuer.

Every person who desires to apply for or otherwise acquire any securities of this Issuer may do so pursuant to independent inquiry, investigation and analysis and shall not have any claim against the Exchange whatsoever by reason of any loss which may be suffered by such person consequent to or in connection with such subscription /acquisition whether by reason of anything stated or omitted to be stated herein or any other reason whatsoever.

Disclaimer Clause of the BSE

BSE Limited ("the Exchange") has given vide its letter dated June 28, 2021 permission to our Company to use the Exchange's name in this Offer Document as one of the stock exchanges on which this company's securities are proposed to be listed. The Exchange has scrutinized this Offer Document for its limited internal purpose of deciding on the matter of granting the aforesaid permission to our Company. The Exchange does not in any manner: -

- a) warrant, certify or endorse the correctness or completeness of any of the contents of this offer document; or
- b) warrant that our Company's securities will be listed or will continue to be listed on the Exchange; or
- c) take any responsibility for the financial or other soundness of our Company, its promoters, its management or any scheme or project of our Company;

and it should not for any reason be deemed or construed that this offer document has been cleared or approved by the Exchange. Every person who desires to apply for or otherwise acquires any securities of this Company may do so pursuant to independent inquiry, investigation and analysis and shall not have any claim against the Exchange whatsoever by reason of any loss which may be suffered by such person consequent to or in connection with such subscription/acquisition whether by reason of anything stated or omitted to be stated herein or for any other reason whatsoever.

Listing

The Equity Shares issued through this Red Herring Prospectus are proposed to be listed on the Stock Exchanges. Application will be made to the Stock Exchanges for obtaining permission for listing and trading of the Equity Shares. BSE will be the Designated Stock Exchange with which the Basis of Allotment will be finalised.

Consents

Consents in writing of: (a) each of the Selling Shareholders, our Directors, our Company Secretary and Compliance Officer, our CFO, Banker(s) to the Company, Statutory Auditors, legal counsels appointed for the Offer, legal counsels to the Selling Shareholders as to Indian law, the BRLMs, the Registrar to the Offer, in their respective capacities, have been obtained; (b) Experts to the Offer has been obtained, and (c) the Banker(s) to the Offer/ Escrow Collection Bank(s)/ Refund Bank(s), Sponsor Bank and Banker to the Company, to act in their respective capacities, have been obtained and filed along with a copy of this Red Herring Prospectus with the RoC as required under the Companies Act and such consents have not been withdrawn up to the time of delivery of this Red Herring Prospectus.

Expert to the Offer

Except as stated below, our Company has not obtained any expert opinions:

Our Company has received written consent dated September 6, 2021 from our Statutory Auditors namely, Deloitte Haskins & Sells, Chartered Accountants to include their name as an “expert” as defined under Section 2(38) of the Companies Act, read with Section 26(5) of the Companies Act, in respect of the examination report dated September 6, 2021 on the Restated Consolidated Financial Information, and the statement of special tax benefits dated September 6, 2021 included in this Red Herring Prospectus, and such consent has not been withdrawn as on the date of this Red Herring Prospectus. However, the term “expert” and the consent thereof shall not be construed to mean an expert or consent within the meaning as defined under the U.S. Securities Act.

Our Company has received written consent from M.S. Balu, Chartered Engineers dated June 3, 2021 and August 18, 2021, to include their name in the Draft Red Herring Prospectus and this Red Herring Prospectus and as “expert” as defined under section 2(38) of the Companies Act in respect of the certificates dated June 3, 2021 and August 18, 2021 and such consent has not been withdrawn as on the date of this Red Herring Prospectus.

Particulars regarding capital issues by our Company and listed group companies, subsidiaries or associate entity during the last three years

Other than as disclosed in “*Capital Structure*” on page 68, our Company has not made any capital issues during the three years preceding the date of this Red Herring Prospectus. Further, our Company does not have any listed Group Companies, Subsidiaries or Associates.

Commission and Brokerage paid on previous issues of the Equity Shares in the last five years

Since this is the initial public issue of the Equity Shares, no sum has been paid or has been payable as commission or brokerage for subscribing to or procuring or agreeing to procure subscription for any of the Equity Shares since our Company’s incorporation.

Performance vis-à-vis objects – Public/ rights issue of our Company

Our Company has not undertaken any public or rights issue in the five years preceding the date of this Red Herring Prospectus.

Performance vis-à-vis objects – Public/ rights issue of the listed subsidiaries/listed Promoters of our Company

The securities of our Subsidiaries are not listed on any stock exchange. Our Company does not have any corporate promoters.

Price information of past issues handled by the BRLMs

A. I-Sec

1. Price information of past issues handled by I-Sec

Sr. No.	Issue Name	Issue Size (₹ in million.)	Issue Price (₹)	Listing Date	Opening Price on Listing Date	+/- % change in closing price, [+/- % change in closing benchmark]- 30 th calendar days from listing	+/- % change in closing price, [+/- % change in closing benchmark]- 90 th calendar days from listing	+/- % change in closing price, [+/- % change in closing benchmark]- 180 th calendar days from listing
1	Suryoday Small Finance Bank Limited	5,808.39	305.00 ⁽¹⁾	26-Mar-21	292.00	-18.38%, [-1.14%]	-26.87%, [+8.13%]	NA*
2	Nazara Technologies Limited	5,826.91	1,101.00 ⁽²⁾	30-Mar-21	1,990.00	+62.57%, [+0.13%]	+37.59%, [+6.84%]	NA*
3	Macrotech Developers Limited	25,000.00	486.00	19-Apr-21	436.00	+30.22%, [+5.21%]	+75.43%, [+10.89%]	NA*
4	Shyam Metals and Energy Limited	9,087.97	306.00 ⁽³⁾	24-Jun-21	380.00	+40.95%, [+0.42%]	NA*	NA*
5	Dodla Dairy Limited	5,201.77	428.00	28-Jun-21	550.00	+44.94%, [-0.43%]	NA*	NA*
6	G R Infraprojects Limited	9,623.34	837.00 ⁽⁴⁾	19-Jul-21	1,715.85	+90.82%, [+5.47%]	NA*	NA*
7	Tatva Chintan Pharma Chem Limited	5,000.00	1,083.00	29-July-21	2,111.85	+92.54%, [+5.87%]	NA*	NA*
8	Nuvoco Vistas Corporation Limited	50,000.00	570.00	23-Aug-21	485.00	NA*	NA*	NA*
9	Chemplast Sanmar Limited	38,500.00	541.00	24-Aug-21	550.00	NA*	NA*	NA*
10	Aptus Value Housing Finance India Limited	27,800.52	353.00	24-Aug-21	333.00	NA*	NA*	NA*

*Data not available

(1) Discount of Rs. 30 per equity share offered to eligible employees All calculations are based on Issue Price of Rs. 305.00 per equity share.

(2) Discount of Rs. 110 per equity share offered to eligible employees All calculations are based on Issue Price of Rs. 1,101.00 per equity share.

(3) Discount of Rs. 15 per equity share offered to eligible employees All calculations are based on Issue Price of Rs. 306.00 per equity share.

(4) Discount of Rs. 42 per equity share offered to eligible employees All calculations are based on Issue Price of Rs. 837.00 per equity share.

2. Summary statement of price information of past issues handled by I-Sec

Financial Year	Total no. of IPOs	Total amount of funds raised (₹ in million)	No. of IPOs trading at discount - 30 th calendar days from listing			No. of IPOs trading at premium - 30 th calendar days from listing			No. of IPOs trading at discount - 180 th calendar days from listing			No. of IPOs trading at premium - 180 th calendar days from listing		
			Over 50%	Between 25-50%	Less than 25%	Over 50%	Between 25-50%	Less than 25%	Over 50%	Between 25-50%	Less than 25%	Over 50%	Between 25-50%	Less than 25%
2021-22*	8	1,70,213.60	-	-	-	2	3	-	-	-	-	-	-	-
2020-21	14	1,74,546.09	-	-	5	5	2	2	-	-	2	4	3	2
2019-20	4	49,850.66	-	-	2	-	1	1	1	-	-	2	-	1

*This data covers issues upto YTD

Notes:

1. All data sourced from www.nseindia.com, except for Computer Age Management Services Limited for which the data is sourced from www.bseindia.com

2. Benchmark index considered is NIFTY

3. 30th, 90th, 180th calendar day from listed day have been taken as listing day plus 29, 89 and 179 calendar days, except wherever 30th, 90th, 180th calendar day is a holiday, in which case we have considered the closing data of the previous trading day

B. IIFL

1. Price information of past issues handled by IIFL

Sr. No.	Issue Name	Issue Size (₹ in million)	Issue Price (₹)	Listing Date	Opening Price on Listing Date	+/- % change in closing price*, [+/- % change in closing benchmark]- 30th calendar days from listing	+/- % change in closing price*, [+/- % change in closing benchmark]- 90th calendar days from listing	+/- % change in closing price*, [+/- % change in closing benchmark]- 180th calendar days from listing
1	Craftsman Automation Limited	8,236.96	1,490.00	March 25, 2021	1,359.00	-13.82%, [+0.11%]	+16.81%, [+10.11%]	N.A.
2	Suryoday Small Finance Bank Ltd	5,808.39	305.00	March 26, 2021	292.00	-18.38%, [-1.14%]	-26.87%, [-98.46%]	N.A.
3	Nazara Technologies Ltd	5,826.91	1,101.00	March 30, 2021	1,990.00	+62.57%, [0.13%]	+38.22%, [6.84%]	N.A.
4	Barbeque-Nation Hospitality Limited	4,528.74	500.00	April 7, 2021	489.85	+18.77%, [-0.64%]	+76.97%, [+6.85%]	N.A.
5	Macrotech Developers Ltd	25,000.00	486.00	April 19, 2021	436.00	+30.22%, [+5.21%]	+75.43%, [+10.89%]	N.A.
6	Shyam Metals and Energy Ltd	9,085.50	306.00	June 24, 2021	380.00	+40.95%, [+0.42%]	N.A.	N.A.
7	Krishna Institute of Medical Sciences Limited	21,437.44	825.00	June 28, 2021	1,009.00	+48.10%; [-0.43%]	N.A.	N.A.
8	Windlas Biotech Limited	4,015.35	460.00	August 16, 2021	437.00	N.A.	N.A.	N.A.
9	Krsnaa Diagnostics Limited	12,133.35	954.00	August 16, 2021	1,005.55	N.A.	N.A.	N.A.
10	Chemplast Sanmar Limited	38,500.00	541.00	August 24, 2021	550.00	N.A.	N.A.	N.A.

Source: www.nseindia.com

Note: Benchmark Index taken as CNX NIFTY. Price on NSE is considered for all of the above calculations. The 30th, 90th and 180th calendar day from listed day have been taken as listing day plus 29, 89 and 179 calendar days, except wherever 30th / 90th / 180th calendar day from listing day is a holiday, the closing data of the previous trading day has been considered. % change taken against the Issue Price in case of the Issuer. The Nifty 50 index is considered as the benchmark index. NA means Not Applicable. The above past price information is only restricted to past 10 initial public offers.

2. Summary statement of price information of past issues handled by IIFL

Financial Year	Total No. of IPO's	Total Funds Raised (₹ in million)	No. of IPOs trading at discount – 30 th calendar days from listing			No. of IPOs trading at premium – 30 th calendar days from listing			No. of IPOs trading at discount – 180 th calendar days from listing			No. of IPOs trading at premium – 180 th calendar days from listing		
			Over 50%	Between 25-50%	Less than 25%	Over 50%	Between 25-50%	Less than 25%	Over 50%	Between 25-50%	Less than 25%	Over 50%	Between 25-50%	Less than 25%
2021-22	6	1,14,700.38	-	-	-	-	3	1	-	-	-	-	-	-
2020-21	8	47,017.65	-	-	4	2	1	1	-	-	-	1	1	1
2019-20	5	65,827.61	-	-	2	-	1	2	1	1	1	-	-	2

Source: www.nseindia.com

Note: Data for number of IPOs trading at premium/discount taken at closing price on NSE on the respective date. In case any of the days falls on a non-trading day, the closing price on the previous trading day has been considered. NA means Not Applicable.

NA means Not Applicable.

C. Nomura

1. Price information of past issues handled by Nomura

Sr. No.	Issue name	Issue size (₹ in million)	Issue price(₹)	Listing date	Opening price on listing date (in ₹)	+/- % change in closing price, [+/- % change in closing benchmark]- 30 th calendar days from listing	+/- % change in closing price, [+/- % change in closing benchmark]- 90 th calendar days from listing	+/- % change in closing price, [+/- % change in closing benchmark]- 180 th calendar days from listing
1	CarTrade Tech Limited	29,985.13	1,618.00	August 20, 2021	1,599.80	Not applicable	Not applicable	Not applicable
2	Sona BLW Precision Forgings Limited	55,500	291	June 24, 2021	301.00	+45.45% [+0.47%]	Not applicable	Not applicable
3	Nazara Technologies Limited	5,826.91	1,101 ¹	March 30, 2021	1,990.00	+62.57% [+0.13%]	+38.22% [+6.84%]	Not applicable
4	Gland Pharma Limited	64,795.45	1,500	November 20, 2020	1,710.00	+48.43% [+7.01%]	+57.27% [+18.27%]	+104.17% [17.49%]
5	Computer Age Management Services Limited	22,421.05	1,230 ²	October 1, 2020	1,518.00	+5.43% [+2.37%]	+49.52% [+23.04%]	+43.80% [+26.65%]
6	Happiest Minds Technologies Limited	7,020.16	166	September 17, 2020	350.00	+96.05% [+2.14%]	+93.25% [+17.82%]	+221.27% [+29.64%]
7	SBI Cards & Payment Services Limited	103,407.88	755 ³	March 16, 2020	661.00	-33.05%, [-2.21%]	-21.79%, [+8.43%]	+12.50% [+24.65%]
8	Affle (India) Limited	4,590.00	745	August 8, 2019	926.00	+12.56%, [-0.78%]	+86.32%, [+8.02%]	+135.49%, [+6.12%]

Source: www.nseindia.com

- Discount of INR110.00 per Equity Share was offered to eligible employees bidding in the Employee Reservation Portion
- Discount of INR122.00 per Equity Share was offered to eligible employees bidding in the Employee Reservation Portion
- Price for Eligible Employees bidding in the Employee Reservation Portion was INR680.00 per equity share

Notes:

- Nifty is considered as the benchmark index except for Computer Age Management Services Limited where SENSEX is considered as benchmark index
- Price on NSE is considered for all of the above calculations except for Computer Age Management Services Limited.
- In case 30th/90th/180th day is not a trading day, closing price on NSE of the previous trading day has been considered.
- Not applicable – Period not completed

2. Summary statement of price information of past issues handled by Nomura

Financial Year	Total no. of IPOs	Total funds raised (₹ in million)	Nos. of IPOs trading at discount on as on 30th calendar days from listing date			Nos. of IPOs trading at premium on as on 30th calendar days from listing date			Nos. of IPOs trading at discount as on 180th calendar days from listing date			Nos. of IPOs trading at premium as on 180th calendar days from listing date		
			Over 50%	Between 25%-50%	Less than 25%	Over 50%	Between 25%-50%	Less than 25%	Over 50%	Between 25%-50%	Less than 25%	Over 50%	Between 25%-50%	Less than 25%
2021-2022	2	85,485.13	-	-	-	-	1	-	-	-	-	-	-	-
2020-2021	4	100,063.57	-	-	-	2	1	1	-	-	-	2	1	-
2019-2020	2	107,997.88	-	1	-	-	-	1	-	-	-	1	-	1

Source: www.nseindia.com

Notes:

- a) The information is as on the date of this document.
- b) The information for each of the financial years is based on issues listed during such financial year.

Track record of past issues handled by the BRLMs

For details regarding the track record of the BRLMs, as specified in circular reference CIR/MIRSD/1/2012 dated January 10, 2012 issued by SEBI, see the websites of the BRLMs, as set forth in the table below:

Sr. No.	Name of BRLM	Website
1.	I-Sec	www.icicisecurities.com
2.	IIFL	www.iiflcap.com
3.	Nomura	www.nomuraholdings.com/company/group/asia/india/index.html

Stock Market Data of Equity Shares

This being an initial public offer of our Company, the Equity Shares are not listed on any stock exchange and accordingly, no stock market data is available for the Equity Shares.

Mechanism for Redressal of Investor Grievances

The Registrar Agreement provides for the retention of records with the Registrar to the Offer for a period of at least eight years from the date of listing and commencement of trading of the Equity Shares on the Stock Exchanges, subject to agreement with our Company for storage of such records for longer period, to enable the investors to approach the Registrar to the Offer for redressal of their grievances.

In terms of SEBI circular SEBI/HO/CFD/DIL2/CIR/P/2018/22 dated February 15, 2018, SEBI circular SEBI/HO/CFD/DIL2/CIR/P/2021/2480/1/M dated March 16, 2021, as amended pursuant to SEBI circular SEBI/HO/CFD/DIL2/P/CIR/2021/570 dated June 2, 2021 and subject to applicable law, any ASBA Bidder whose Bid has not been considered for Allotment, due to failure on the part of any SCSB, shall have the option to seek redressal of the same by the concerned SCSB within three months of the date of listing of the Equity Shares. SCSBs are required to resolve these complaints within 15 days, failing which the concerned SCSB would have to pay interest at the rate of 15% per annum for any delay beyond this period of 15 days. Further, the investors shall be compensated by the SCSBs in accordance with SEBI circular SEBI/HO/CFD/DIL2/CIR/P/2021/2480/1/M dated March 16, 2021 in the events of delayed unblock for cancelled/withdrawn/deleted applications, blocking of multiple amounts for the same UPI application, blocking of more amount than the application amount, delayed unblocking of amounts for non-allotted/partially-allotted applications, for the stipulated period. In an event there is a delay in redressal of the investor grievance in relation to unblocking of amounts, the Book Running Lead Managers shall compensate the investors at the rate higher of ₹ 100 or 15% per annum of the application amount for the period of such delay.

All grievances in relation to the Bidding process may be addressed to the Registrar to the Offer with a copy to the relevant Designated Intermediary to whom the Bid cum Application Form was submitted. The Bidder should give full details such as name of the sole or first Bidder, Bid cum Application Form number, Bidder DP ID, Client ID, UPI ID, PAN, date of the submission of Bid cum Application Form, address of the Bidder, number of the Equity Shares applied for and the name and address of the Designated Intermediary where the Bid cum Application Form was submitted by the Bidder.

The Registrar to the Offer shall obtain the required information from the SCSBs and Sponsor Banks for addressing any clarifications or grievances of ASBA Bidders. Our Company, the BRLMs and the Registrar to the Offer accept no responsibility for errors, omissions, commission or any acts of SCSBs including any defaults in complying with its obligations under applicable SEBI ICDR Regulations. Investors can contact our Company Secretary and Compliance Officer or the Registrar to the Offer in case of any pre-Offer or post-Offer related problems such as non-receipt of letters of Allotment, non-credit of allotted Equity Shares in the respective beneficiary account, non-receipt of refund intimations and non-receipt of funds by electronic mode.

Anchor Investors are required to address all grievances in relation to the Offer to the BRLMs.

Further, the Bidder shall also enclose a copy of the Acknowledgment Slip duly received from the concerned Designated Intermediary in addition to the information mentioned hereinabove.

Disposal of Investor Grievances by our Company

Our Company has obtained authentication on the SCORES to comply with the SEBI circular (CIR/OIAE/1/2014) dated December 18, 2014 in relation to redressal of investor grievances through SCORES.

Our Company and Subsidiaries have not received any investor grievances in the last three Financial Years prior to the filing of the Draft Red Herring Prospectus.

After March 31, 2021, our Company and Subsidiaries have not received any investor grievances which were not resolved. As at the date of this Red Herring Prospectus there are no outstanding investor grievances.

Our Company has appointed Rajesh Kumar Modi, as the Company Secretary and Compliance Officer for the Offer and he may be contacted in case of any pre-Offer or post-Offer related problems. For details, see “*General Information – Company Secretary and Compliance Officer*” on page 61.

Our Company has also constituted a Stakeholders’ Relationship Committee comprising of Muthuswami Lakshminarayan (*Chairperson*), Fatheraj Singhvi and Subramonia Sekhar Vasan as members, to review and redress shareholder and investor grievances. For details, see “*Our Management – Stakeholders’ Relationship Committee*” on page 205.

SECTION VII: OFFER INFORMATION

TERMS OF THE OFFER

The Equity Shares being offered and Allotted pursuant to the Offer shall be subject to the provisions of the Companies Act, SEBI ICDR Regulations, SCRA, SCRR, the MoA, AoA, Listing Regulations, the terms of this Red Herring Prospectus, the Prospectus, the abridged prospectus, Bid cum Application Form, the Revision Form, the CAN/Allotment Advice and other terms and conditions as may be incorporated in other documents/ certificates that may be executed in respect of the Offer. The Equity Shares shall also be subject to laws as applicable, guidelines, rules, notifications and regulations relating to the issue of capital and listing and trading of securities issued from time to time by SEBI, the Government of India, the Stock Exchanges, the RBI, RoC and/or other authorities, as in force on the date of the Offer and to the extent applicable or such other conditions as may be prescribed by the SEBI, the Government of India, the Stock Exchanges, the RoC and/or any other authorities while granting its approval for the Offer.

Ranking of the Equity Shares

The Allottees upon Allotment of Equity Shares under the Offer will be entitled to dividend and other corporate benefits, if any, declared by our Company after the date of Allotment. The Equity Shares transferred in the Offer shall be *pari passu* with the existing Equity Shares in all respects including dividends. For further details, see “*Description of Equity Shares and Terms of Articles of Association*” on page 360.

Mode of Payment of Dividend

Our Company shall pay dividends, if declared, to the Shareholders in accordance with the provisions of the Companies Act, the Memorandum and Articles of Association and provisions of the Listing Regulations and any other guidelines or directions which may be issued by the Government in this regard. Dividends, if any, declared by our Company after the date of Allotment (pursuant to the transfer of Equity Shares from the Offer for Sale), will be payable to the Bidders who have been Allotted Equity Shares in the Offer, for the entire year, in accordance with applicable laws. For further details, in relation to dividends, see “*Dividend Policy*” and “*Description of Equity Shares and Terms of Articles of Association*” on pages 218 and 360, respectively.

Face Value, Offer Price and Price Band

The face value of each Equity Share is ₹2 and the Offer Price at the lower end of the Price Band is ₹[●] per Equity Share and at the higher end of the Price Band is ₹[●] per Equity Share. The Anchor Investor Offer Price is ₹[●] per Equity Share.

The Price Band will be decided by our Company with the consent of the Investor Selling Shareholders in consultation with the BRLMs and the Promoter Selling Shareholders, and the minimum Bid Lot size for the Offer will be decided by our Company in consultation with the BRLMs and the Selling Shareholders, and advertised in all editions of Financial Express, an English national daily newspaper, Delhi edition of Jansatta, a Hindi national daily newspaper and Bangalore edition of Vishwavani a Kannada national daily newspaper, Kannada being the regional language of Karnataka, where our Registered Office and Corporate Office is located, each with wide circulation, at least two Working Days prior to the Bid/Offer Opening Date and shall be made available to the Stock Exchanges for the purpose of uploading the same on their websites. The Price Band, along with the relevant financial ratios calculated at the Floor Price and at the Cap Price, shall be pre-filled in the Bid cum Application Forms available on the respective websites of the Stock Exchanges.

At any given point of time, there shall be only one denomination for the Equity Shares.

The Offer

The Offer comprises an Offer for Sale by the Selling Shareholders.

Expenses for the Offer shall be shared amongst the Company and the Selling Shareholders in the manner specified in “*Objects of the Offer - Offer related expenses*” on page 84.

Rights of the Equity Shareholders

Subject to applicable laws, rules, regulations and guidelines and the Articles of Association, our equity Shareholders shall have the following rights:

- Right to receive dividends, if declared;
- Right to attend general meetings and exercise voting rights, unless prohibited by law;
- Right to vote on a poll either in person or by proxy, in accordance with the provisions of the Companies Act;

- Right to receive offers for rights shares and be allotted bonus shares, if announced;
- Right to receive surplus on liquidation, subject to any statutory and preferential claim being satisfied;
- Right of free transferability, subject to applicable laws including any RBI rules and regulations; and
- Such other rights, as may be available to a shareholder of a listed public company under the Companies Act, the Listing Regulations and the Articles of Association of our Company.

For a detailed description of the main provisions of the Articles of Association of our Company relating to voting rights, dividend, forfeiture and lien, transfer, transmission and/or consolidation/splitting, see “*Description of Equity Shares and Terms of Articles of Association*” on page 360.

Allotment only in dematerialised form

Pursuant to Section 29 of the Companies Act, 2013 and the SEBI ICDR Regulations, the Equity Shares shall be Allotted only in dematerialised form. As per the SEBI ICDR Regulations, the trading of the Equity Shares shall only be in dematerialised form on the Stock Exchanges. In this context, our Company has entered into the following agreements with the respective Depositories and Registrar to the Offer:

- Tripartite agreement dated September 11, 2018 amongst our Company, NSDL and Registrar to the Offer; and
- Tripartite agreement dated September 10, 2018 amongst our Company, CDSL and Registrar to the Offer.

Retail Discount and Employee Discount

Retail Discount and Employee Discount, if any, may be offered to RIBs bidding in the Retail Portion or the Eligible Employees bidding in the Employee Reservation Portion, respectively. Eligible Employees bidding in the Employee Reservation Portion and RIBs bidding in the Retail Portion at a price within the Price Band can make payment at Bid Amount, that is, Bid Amount net of Employee Discount or Retail Discount, as applicable at the time of making a Bid. Eligible Employees bidding in the Employee Reservation Portion respectively at the Cut-Off Price have to ensure payment at the Cap Price, less Employee Discount, as applicable, at the time of making a Bid. Retail Individual Bidders Bidding at the Cut-Off Price have to ensure payment at the Cap Price, less Retail Discount, as applicable, at the time of making a Bid.

Market Lot and Trading Lot

Since trading of the Equity Shares is in dematerialised form, the tradable lot is one Equity Share. Allotment in the Offer will be in multiples of one Equity Share subject to a minimum Allotment of [●] Equity Shares.

Joint Holders

Subject to the provisions of the Articles of Association, where two or more persons are registered as the holders of the Equity Shares, they will be deemed to hold such Equity Shares as joint tenants with benefits of survivorship.

Nomination facility to investors

In accordance with Section 72 of the Companies Act, 2013, read with the Companies (Share Capital and Debentures) Rules, 2014, the sole Bidder, or the first Bidder along with other joint Bidders, may nominate any one person in whom, in the event of the death of sole Bidder or in case of joint Bidders, death of all the Bidders, as the case may be, the Equity Shares Allotted, if any, shall vest. A person, being a nominee, entitled to the Equity Shares by reason of the death of the original holder(s), shall be entitled to the same advantages to which he or she would be entitled if he or she were the registered holder of the Equity Share(s). Where the nominee is a minor, the holder(s) may make a nomination to appoint, in the prescribed manner, any person to become entitled to Equity Share(s) in the event of his or her death during the minority. A nomination shall stand rescinded upon a sale/transfer/alienation of Equity Share(s) by the person nominating. A buyer will be entitled to make a fresh nomination in the manner prescribed. Fresh nomination can be made only on the prescribed form available on request at our Registered Office and Corporate Office or to the registrar and transfer agents of our Company.

Any person who becomes a nominee by virtue of the provisions of Section 72 of the Companies Act, 2013 shall upon the production of such evidence as may be required by the Board, elect either:

- a) to register himself or herself as the holder of the Equity Shares; or
- b) to make such transfer of the Equity Shares, as the deceased holder could have made.

Further, the Board may at any time give notice requiring any nominee to choose either to be registered himself or herself or to

transfer the Equity Shares, and if the notice is not complied with within a period of 90 days, the Board may thereafter withhold payment of all dividends, bonuses or other monies payable in respect of the Equity Shares, until the requirements of the notice have been complied with.

Since the Allotment of Equity Shares in the Offer will be made only in dematerialised mode, there is no need to make a separate nomination with our Company. Nominations registered with respective Depository Participant of the Bidder would prevail. If the Bidder wants to change the nomination, they are requested to inform their respective Depository Participant.

Our Company shall comply with such disclosure and accounting norms as may be specified by SEBI from time to time.

Bid/Offer Programme

BID/OFFER OPENS ON	September 14, 2021 ⁽¹⁾
BID/OFFER CLOSSES ON	September 16, 2021 ⁽²⁾⁽³⁾

- (1) Our Company with the consent of the Investor Selling Shareholders in consultation with the BRLMs and the Promoter Selling Shareholders, may consider participation by Anchor Investors. The Anchor Investor Bid/Offer Period shall be one Working Day prior to the Bid/Offer Opening Date in accordance with the SEBI ICDR Regulations.
- (2) Our Company and the Investor Selling Shareholders and in consultation with the BRLMs and the Promoter Selling Shareholders may, consider closing the Bid/Offer Period for QIBs one day prior to the Bid/Offer Closing Date in accordance with the SEBI ICDR Regulations.
- (3) UPI mandate end time and date shall be at 12.00pm on September 17, 2021.

An indicative timetable in respect of the Offer is set out below:

Event	Indicative Date
Finalisation of Basis of Allotment with the Designated Stock Exchange	On or about September 21, 2021
Initiation of refunds (if any, for Anchor Investors)/unblocking of funds from ASBA Account*	On or about September 22, 2021
Credit of Equity Shares to demat accounts of Allottees	On or about September 23, 2021
Commencement of trading of the Equity Shares on the Stock Exchanges	On or about September 24, 2021

* In case of (i) any delay in unblocking of amounts in the ASBA Accounts (including amounts blocked through the UPI Mechanism) for cancelled/ withdrawn/ deleted ASBA Forms, the Bidder shall be compensated at a uniform rate of ₹100 per day or 15% per annum of the Bid Amount, whichever is higher from the date on which the request for cancellation/ withdrawal/ deletion is placed in the Stock Exchanges bidding platform until the date on which the amounts are unblocked (ii) any blocking of multiple amounts for the same ASBA Form (for amounts blocked through the UPI Mechanism), the Bidder shall be compensated at a uniform rate ₹100 per day or 15% per annum of the total cumulative blocked amount except the original application amount, whichever is higher from the date on which such multiple amounts were blocked till the date of actual unblock; (iii) any blocking of amounts more than the Bid Amount, the Bidder shall be compensated at a uniform rate of ₹100 per day or 15% per annum of the difference in amount, whichever is higher from the date on which such excess amounts were blocked till the date of actual unblock; (iv) any delay in unblocking of non-allotted/ partially allotted Bids, exceeding four Working Days from the Bid/Offer Closing Date, the Bidder shall be compensated at a uniform rate of ₹100 per day or 15% per annum of the Bid Amount, whichever is higher for the entire duration of delay exceeding four Working Days from the Bid/ Offer Closing Date by the SCSB responsible for causing such delay in unblocking. The BRLMs shall be liable for compensating the Bidder at a uniform rate of ₹100 per day or 15% per annum of the Bid Amount, whichever is higher from the date of receipt of the Investor grievance until the date on which the blocked amounts are unblocked.

The above timetable, other than the Bid/Offer Closing Date, is indicative and does not constitute any obligation or liability on our Company, our Selling Shareholders or the BRLMs.

Whilst our Company shall ensure that all steps for the completion of the necessary formalities for the listing and the commencement of trading of the Equity Shares on the Stock Exchanges are taken within six Working Days of the Bid/Offer Closing Date, the timetable may be extended due to various factors, such as extension of the Bid/Offer Period by our Company with the consent of the Investor Selling Shareholders in consultation with the BRLMs and the Promoter Selling Shareholders, revision of the Price Band or any delay in receiving the final listing and trading approval from the Stock Exchanges. The commencement of trading of the Equity Shares will be entirely at the discretion of the Stock Exchanges and in accordance with the applicable laws. Each Selling Shareholder confirms that it shall extend such reasonable support and co-operation required by our Company and the BRLMs for completion of the necessary formalities for listing and commencement of trading of the Equity Shares at the Stock Exchanges within six Working Days from the Bid/Offer Closing Date or such other period as may be prescribed by SEBI.

In terms of the UPI Circulars, in relation to the Offer, the BRLMs will be required to submit reports of compliance with timelines and activities prescribed by SEBI in connection with the allotment and listing procedure within six Working Days from the Bid/Offer Closing Date, identifying non-adherence to timelines and processes and an analysis of entities responsible for the delay and the reasons associated with it.

Submission of Bids (other than Bids from Anchor Investors):

Bid/Offer Period (except the Bid/Offer Closing Date)	
Submission and Revision in Bids	Only between 10.00 a.m. and 5.00 p.m. (Indian Standard Time (“IST”))
Bid/Offer Closing Date*	
Submission and Revision in Bids	Only between 10.00 a.m. and 3.00 p.m. IST

*UPI mandate end time and date shall be at 12.00 pm on September 17, 2021.

On the Bid/ Offer Closing Date, the Bids shall be uploaded until:

- (i) 4.00 p.m. IST in case of Bids by QIBs and Non-Institutional Bidders, and
- (ii) until 5.00 p.m. IST or such extended time as permitted by the Stock Exchanges, in case of Bids by RIB and Eligible Employees under the Employee Reservation Portion.

On Bid/Offer Closing Date, extension of time may be granted by Stock Exchanges only for uploading Bids received by Retail Individual Bidders and Eligible Employees, after taking into account the total number of Bids received and as reported by the BRLMs to the Stock Exchanges.

The Registrar to the Offer shall submit the details of cancelled/withdrawn/deleted applications to the SCSB's on daily basis within 60 minutes of the Bid closure time from the Bid/ Offer Opening Date till the Bid/Offer Closing Date by obtaining the same from the Stock Exchanges. The SCSB's shall unblock such applications by the closing hours of the Working Day.

It is clarified that Bids not uploaded on the electronic bidding system or in respect of which the full Bid Amount is not blocked by SCSBs, or not blocked under the UPI Mechanism in the relevant ASBA Account, as the case may be would be rejected.

Due to limitation of time available for uploading the Bids on the Bid/Offer Closing Date, Bidders are advised to submit their Bids one day prior to the Bid/Offer Closing Date. Any time mentioned in this Red Herring Prospectus is IST. Bidders are cautioned that, in the event a large number of Bids are received on the Bid/Offer Closing Date, some Bids may not get uploaded due to lack of sufficient time. Such Bids that cannot be uploaded will not be considered for allocation under the Offer. Bids will be accepted only during Working Days during the Bid/ Offer Period. In case of any discrepancy in the data entered in the electronic book vis-à-vis the data contained in the physical Bid cum Application Form, for a particular Bidder, the details as per the Bid file received from the Stock Exchanges shall be taken as the final data for the purpose of Allotment. In case of any discrepancy in the data entered in the electronic book vis-à-vis the data contained in the physical Bid cum Application Form, for a particular Bidder, the details as per the Bid file received from the Stock Exchanges shall be taken as the final data for the purpose of Allotment.

Our Company with the consent of the Investor Selling Shareholders, in consultation with the BRLMs and the Promoter Selling Shareholders reserve the right to revise the Price Band during the Bid/Offer Period. The revision in the Price Band shall not exceed 20% on either side, i.e. the Floor Price can move up or down to the extent of 20% of the Floor Price and the Cap Price will be revised accordingly, but the Floor Price shall not be less than the face value of the Equity Shares.

In case of revision in the Price Band, the Bid/Offer Period shall be extended for at least three additional Working Days after such revision, subject to the Bid/Offer Period not exceeding 10 Working Days. In cases of force majeure, banking strike or similar circumstances, our Company with the consent of the Investor Selling Shareholders in consultation with the BRLMs and the Promoter Selling Shareholders, for reasons to be recorded in writing, extend the Bid/Offer Period for a minimum of three Working Days, subject to the Bid/ Offer Period not exceeding 10 Working Days. Any revision in Price Band, and the revised Bid/Offer Period, if applicable, shall be widely disseminated by notification to the Stock Exchanges, by issuing a press release and also by indicating the change on the terminals of the Syndicate and by intimation to the Designated Intermediaries.

In case of discrepancy in data entered in the electronic book vis-vis data contained in the Bid cum Application Form for a particular Bidder, the details as per the Bid file received from the Stock Exchanges shall be taken as the final data for the purpose of Allotment.

Minimum Subscription

As this is an offer for sale by the Selling Shareholders, the requirement of minimum subscription of 90% of the Fresh Issue under the SEBI ICDR Regulations is not applicable to this Offer. However, if our Company does not receive the minimum subscription in the Offer as specified under the terms of Rule 19(2)(b) of the SCRR, as applicable, on the date of closure of the Offer or withdrawal of applications; or after technical rejections; or if the listing or trading permission are not obtained from the Stock Exchanges for the Equity Shares so offered under the Offer document, our Company shall forthwith refund the entire subscription amount received. If there is a delay beyond the prescribed time, our Company and every Director of our Company, who is an officer in default, shall pay interest at the rate as prescribed under the applicable law.

Further, our Company and the Selling Shareholders shall ensure that the number of prospective Allottees to whom the Equity Shares will be Allotted shall not be less than 1,000 in compliance with Regulation 49(1) of SEBI ICDR Regulations, failing which, the entire application money shall be unblocked in the respective ASBA Accounts of the Bidders. In case of delay, if any, in unblocking the ASBA Accounts within such timeline as prescribed under applicable laws, our Company and the Selling Shareholders shall be liable to pay interest on the application money in accordance with applicable laws. In case of an undersubscription in the Offer, the Equity Shares proposed for sale by each Selling Shareholder shall be in proportion to the Offered Shares by such Selling Shareholder.

Each Selling Shareholder, shall severally and not jointly, reimburse, in proportion to their respective Offered Shares, any

expenses and interest incurred by our Company on behalf of such Selling Shareholder for any delays in making refunds as required under the Companies Act and any other applicable law, provided that such Selling Shareholder shall not be responsible or liable for payment of such expenses or interest, unless such delay is solely and directly attributable to an act or omission of such respective Selling Shareholder.

Arrangements for Disposal of Odd Lots

There are no arrangements for disposal of odd lots since our Equity Shares will be traded in dematerialised form only and market lot for our Equity Shares will be one Equity Share.

Restrictions, if any on Transfer and Transmission of Equity Shares

Except for lock-in of the pre-Offer capital of our Company, lock-in of our Promoters' minimum contribution under the SEBI ICDR Regulations and the Anchor Investor lock-in as provided in "*Capital Structure*" on page 68 and except as provided under the Articles of Association, there are no restrictions on transfer of the Equity Shares. Further, there are no restrictions on transmission of any shares of our Company and on their consolidation or splitting, except as provided in the Articles of Association. For details, see "*Description of Equity Shares and Terms of Articles of Association*" on page 360.

OFFER STRUCTURE

Initial public offer of up to 17,244,328 Equity Shares for cash at price of ₹[●] per Equity Share aggregating up to ₹[●] million through an Offer of Sale by the Selling Shareholders.

This Offer includes a reservation of up to [●] Equity Shares (constituting up to [●]% of the post-Offer paid-up equity share capital) for purchase by Eligible Employees. The Offer and the Net Offer would constitute at least [●]% and [●]%, respectively, of our post-Offer paid-up equity share capital.

The face value of the Equity Shares is ₹2 each. The Offer is being made through the Book Building Process.

Particulars	Eligible Employees [#]	QIBs ⁽¹⁾	Non-Institutional Bidders	Retail Individual Bidders
Number of Equity Shares available for Allotment or allocation ^{*(2)}	Up to [●] Equity Shares	Not more than [●] Equity Shares	Not less than [●] Equity Shares available for allocation or Offer less allocation to QIB Bidders and Retail Individual Bidders	Not less than [●] Equity Shares available for allocation or Offer less allocation to QIB Bidders and Non-Institutional Bidders
Percentage of Offer size available for Allotment or allocation	The Employee Reservation Portion shall constitute upto [●]% of the post-Offer paid-up Equity Share capital of our Company	Not more than 50% of the Offer being available for allocation to QIB Bidders. However, 5% of the Net QIB Portion will be available for allocation proportionately to Mutual Funds only. Mutual Funds participating in the Mutual Fund Portion will also be eligible for allocation in the remaining QIB Portion. The unsubscribed portion in the Mutual Fund Portion will be added to the Net QIB Portion	Not less than 15% of the Offer or the Offer less allocation to QIB Bidders and Retail Individual Bidders	Not less than 35% of the Offer or the Offer less allocation to QIB Bidders and Non-Institutional Bidders
Basis of Allotment if respective category is oversubscribed*	Proportionate, unless the Employee Reservation Portion is undersubscribed, the value of allocation to an Eligible Employee shall not exceed ₹200,000 (net of Employee Discount, if any). In the event of undersubscription in the Employee Reservation Portion, the unsubscribed portion may be allocated, on a proportionate basis, to Eligible Employees for value exceeding ₹200,000 (net of Employee Discount, if any), subject to total Allotment to an Eligible Employee not exceeding ₹500,000 (net of Employee Discount if any).	Proportionate as follows: (a) up to [●] Equity Shares shall be available for allocation on a proportionate basis to Mutual Funds only; and (b) up to [●] Equity Shares shall be available for allocation on a proportionate basis to all QIBs, including Mutual Funds receiving allocation as per (a) above. Upto 60% of the QIB Portion i.e. up to [●] Equity Shares may be allocated on a discretionary basis to Anchor Investors of which one-third shall be available for allocation to Mutual Funds only	Proportionate	The allotment to each Retail Individual Bidder shall not be less than the minimum Bid Lot, subject to availability of Equity Shares in the Retail Portion and the remaining available Equity Shares if any, shall be Allotted on a proportionate basis. For further details, see “Offer Procedure” on page 344.
Minimum Bid	[●] Equity Shares	Such number of Equity Shares in multiples of [●] Equity Shares such that the Bid Amount exceeds ₹200,000.	Such number of Equity Shares in multiples of [●] Equity Shares such that the Bid Amount exceeds ₹200,000.	[●] Equity Shares
Maximum Bid	Such number of Equity Shares and in multiples of [●] Equity Shares, so that the maximum Bid	Such number of Equity Shares in multiples of [●] Equity Shares not exceeding the size of the	Such number of Equity Shares in multiples of [●] Equity Shares not exceeding the size of the Offer, (excluding the QIB	Such number of Equity Shares in multiples of [●] Equity Shares so that the Bid Amount does not exceed

Particulars	Eligible Employees [#]	QIBs ⁽¹⁾	Non-Institutional Bidders	Retail Individual Bidders
	Amount by each Eligible Employee in Eligible Employee Portion does not exceed ₹500,000, less Employee Discount, if any	Offer, subject to applicable limits	Portion) subject to limits applicable to the Bidder	₹200,000 (net of Retail Discount)
Mode of Bid	Through ASBA Process only, including UPI ID for RIBs using UPI Mechanism (except in case of Anchor Investors)			
Mode of Allotment	Compulsorily in dematerialised form			
Bid Lot	[●] Equity Shares and in multiples of [●] Equity Shares thereafter			
Allotment Lot	[●] Equity Shares and in multiples of one Equity Share thereafter			
Trading Lot	One Equity Share			
Who can apply ⁽³⁾	Eligible Employees	Public financial institutions as specified in Section 2(72) of the Companies Act 2013, scheduled commercial banks, mutual funds registered with SEBI, FPIs other than individuals, corporate bodies and family offices, FVCIs, VCFs, AIFs, state industrial development corporation, insurance company registered with IRDAI, provident fund with minimum corpus of ₹250 million, pension fund with minimum corpus of ₹250 million National Investment Fund set up by the Government, insurance funds set up and managed by army, navy or air force of the Union of India, insurance funds set up and managed by the Department of Posts, India and Systemically Important NBFCs.	Resident Indian individuals, Eligible NRIs, HUFs (in the name of Karta), companies, corporate bodies, scientific institutions, societies and trusts, family offices and FPIs who are individuals, corporate bodies and family offices	Resident Indian individuals, Eligible NRIs and HUFs (in the name of the karta)
Terms of Payment		In case of Anchor Investors: Full Bid Amount shall be payable by the Anchor Investors at the time of submission of their Bids ⁽⁴⁾ In case of all other Bidders: Full Bid Amount shall be blocked by the SCSBs in the bank account of the ASBA Bidder, or by the Sponsor Bank through the UPI Mechanism (for Retail Individual Bidders), that is specified in the ASBA Form at the time of submission of the ASBA Form		

* Assuming full subscription in the Offer

Eligible Employees Bidding in the Employee Reservation portion can Bid up to a Bid Amount of ₹500,000. However, a Bid by an Eligible Employee in the Employee Reservation Portion will be considered for allocation, in the first instance, for a Bid Amount of up to ₹200,000. In the event of under-subscription in the Employee Reservation Portion, the unsubscribed portion will be available for allocation and Allotment, proportionately to all Eligible Employees who have Bid in excess of ₹200,000, subject to the maximum value of Allotment made to such Eligible Employee not exceeding ₹500,000. Further, an Eligible Employee Bidding in the Employee Reservation Portion can also Bid in the Net Offer and such Bids will not be treated as multiple Bids subject to applicable limits. The unsubscribed portion if any, in the Employee Reservation Portion shall be added back to the Net Offer. In case of under-subscription in the Net Offer, spill-over to the extent of such under-subscription shall be permitted from the Employee Reservation Portion.

(1) Our Company with the consent of the Investor Selling Shareholders in consultation with the BRLMs and the Promoter Selling Shareholders, may allocate up to 60% of the QIB Portion to Anchor Investors on a discretionary basis in accordance with the SEBI ICDR Regulations. One-third of the Anchor Investor Portion shall be reserved for domestic Mutual Funds, subject to valid Bids being received from domestic Mutual Funds at or above the price Anchor Investor Allocation Price. In the event of under-subscription or non-Allotment in the Anchor Investor Portion, the balance Equity Shares in the Anchor Investor Portion shall be added to the Net QIB Portion. For details, see "Offer Structure" on page 341.

(2) Subject to valid Bids being received at or above the Offer Price. This Offer is being made in accordance with Rule 19(2) of the SCRR and Regulation 6(1) of the SEBI ICDR Regulations.

(3) In case of joint Bids, the Bid cum Application Form should contain only the name of the first Bidder whose name should also appear as the first holder of the beneficiary account held in joint names. The signature of only such first Bidder would be required in the Bid cum Application Form and such first Bidder would be deemed to have signed on behalf of the joint holders. Further, a Bidder Bidding in the Employee Reservation Portion may also Bid under the Net Offer and such Bids shall not be treated as multiple Bids. To clarify, an Eligible Employee Bidding in the Employee Reservation Portion above ₹500,000 shall not be allowed to Bid in the Net Offer as such Bids shall be treated as multiple Bids.

(4) Full Bid Amount shall be payable by the Anchor Investors at the time of submission of the Anchor Investor Application Forms provided that any difference between the Anchor Investor Allocation Price and the Anchor Investor Offer Price shall be payable by the Anchor Investor Pay-In Date as indicated in the CAN.

(5) The Bids by FPIs with certain structures as described under "Offer Procedure - Bids by FPIs" on page 348 and having same PAN may be collated and

identified as a single Bid in the Bidding process. The Equity Shares Allocated and Allotted to such successful Bidders (with same PAN) may be proportionately distributed. Bidders will be required to confirm and will be deemed to have represented to our Company, the Underwriters, their respective directors, officers, agents, affiliates and representatives that they are eligible under applicable law, rules, regulations, guidelines and approvals to acquire the Equity Shares.

Any unsubscribed portion remaining in the Employee Reservation Portion shall be added to the Net Offer. Allotment to an Eligible Employee in the Employee Reservation Portion may not exceed ₹200,000 in value (net of Employee Discount, if any).

Only in the event of an under-subscription in the Employee Reservation Portion, post the initial Allotment, such unsubscribed portion may be Allotted on a proportionate basis to Eligible Employees Bidding in the Employee Reservation Portion, subject to the total Allotment to an Eligible Employee not exceeding ₹500,000 in value (net of Employee Discount, if any).

Subject to valid Bids being received at or above the Offer Price (net of Retail Discount, if any), under-subscription, if any, in any category except the QIB Portion, would be allowed to be met with spill over from any other category or combination of categories at the discretion of our Company and the Investor Selling Shareholders, in consultation with the BRLMs, the Promoter Selling Shareholders and the Designated Stock Exchange, on a proportionate basis.

Withdrawal of the Offer

Our Company and Selling Shareholders, in consultation with the BRLMs, reserve the right not to proceed with the Offer, after the Bid/ Offer Opening Date but before the Allotment. In such an event, our Company would issue a public notice in the newspapers in which the pre-Offer advertisements were published, within two days of the Bid/ Offer Closing Date or such other time as may be prescribed by SEBI, providing reasons for not proceeding with the Offer and inform the Stock Exchanges promptly on which the Equity Shares are proposed to be listed. The BRLMs, through the Registrar to the Offer, shall notify the SCSBs and the Sponsor Company, to unblock the bank accounts of the ASBA Bidders within one Working Day from the date of receipt of such notification and also inform the Bankers to the Offer to process refunds to the Anchor Investors, as the case may be.

If our Company and Selling Shareholders, in consultation with the BRLMs withdraw the Offer after the Bid/ Offer Closing Date and thereafter determines that it will proceed with an issue of the Equity Shares, our Company shall file a fresh draft red herring prospectus with SEBI. Notwithstanding the foregoing, this Offer is also subject to obtaining (i) the final listing and trading approvals of the Stock Exchanges, which our Company shall apply for after Allotment; and (ii) the final RoC approval of the Prospectus after it is filed with the RoC.

OFFER PROCEDURE

All Bidders should read the General Information Document which highlights the key rules, processes and procedures applicable to public issues in general in accordance with the provisions of the Companies Act, the SCRA, the SCRR and the SEBI ICDR Regulations which is part of the abridged prospectus accompanying the Bid cum Application Form. The General Information Document is available on the websites of the Stock Exchanges and the BRLMs. Please refer to the relevant provisions of the General Information Document which are applicable to the Offer.

Additionally, all Bidders may refer to the General Information Document for information in relation to (i) category of investors eligible to participate in the Offer; (ii) maximum and minimum Bid size; (iii) price discovery and allocation; (iv) payment instructions for ASBA Bidders/Applicants; (v) issuance of CAN and Allotment in the Offer; (vi) general instructions (limited to instructions for completing the Bid cum Application Form); (vii) submission of Bid cum Application Form; (viii) other instructions (limited to joint bids in cases of individual, multiple bids and instances when an application would be rejected on technical grounds); (ix) applicable provisions of the Companies Act, 2013 relating to punishment for fictitious applications; (x) mode of making refunds; (xi) Designated Date and (xii) interest in case of delay in allotment or refund.

SEBI vide its circular no. SEBI/HO/CFD/DIL2/CIR/P/2018/138 dated November 1, 2018 read with its circular no. SEBI/HO/CFD/DIL2/CIR/P/2019/50 dated April 3, 2019, has introduced an alternate payment mechanism using Unified Payments Interface (“UPI”) and consequent reduction in timelines for listing in a phased manner. From January 1, 2019, the UPI Mechanism for RIBs applying through Designated Intermediaries was made effective along with the existing process and existing timeline of T+6 days. (“UPI Phase I”). The UPI Phase I was effective till June 30, 2019.

With effect from July 1, 2019, SEBI vide its circular no. SEBI/HO/CFD/DIL2/CIR/P/2019/76 dated June 28, 2019, read with circular bearing number SEBI/HO/CFD/DIL2/CIR/P/2019/85 dated July 26, 2019 with respect to Bids by RIBs through Designated Intermediaries (other than SCSBs), the existing process of physical movement of forms from such Designated Intermediaries to SCSBs for blocking of funds has been discontinued and only the UPI Mechanism for such Bids with existing timeline of T+6 days was mandated for a period of three months or launch of five main board public issues, whichever is later (“UPI Phase II”). Subsequently, however, SEBI vide its circular no. SEBI/HO/CFD/DIL2/CIR/P/2020/50 dated March 30, 2020 extended the timeline for implementation of UPI Phase II till further notice. The final reduced timeline will be made effective using the UPI Mechanism for applications by RIBs (“UPI Phase III”), as may be prescribed by SEBI. The Offer will be undertaken pursuant to the processes and procedures under UPI Phase II, subject to any circulars, clarification or notification issued by the SEBI from time to time. Further, SEBI vide its circular no. SEBI/HO/CFD/DIL2/CIR/P/2021/2480/1/M dated March 16, 2021 (“March 16 Circular”) has introduced certain additional measures for streamlining the process of initial public offers and redressing investor grievances. This circular shall come into force for initial public offers opening on/or after May 1, 2021 and the provisions of this circular are deemed to form part of this Red Herring Prospectus. Subsequently, SEBI vide its circular no. SEBI/HO/CFD/DIL2/P/CIR/2021/570 dated June 2, 2021 modifying the process timelines and extending the implementation timelines for certain measures introduced by the March 16 Circular.

Our Company, the Selling Shareholders and the BRLMs do not accept any responsibility for the completeness and accuracy of the information stated in this section and are not liable for any amendment, modification or change in the applicable law which may occur after the date of this Red Herring Prospectus. Bidders are advised to make their independent investigations and ensure that their Bids are submitted in accordance with applicable laws and do not exceed the investment limits or maximum number of the Equity Shares that can be held by them under applicable law or as specified in this Red Herring Prospectus and the Prospectus.

Further, our Company and the Members of the Syndicate are not liable for any adverse occurrences consequent to the implementation of the UPI Mechanism for application in the Offer.

Book Building Procedure

The Offer is being made through the Book Building Process in accordance with Regulation 6(1) of the SEBI ICDR Regulations wherein not more than 50% of the Offer shall be allocated on a proportionate basis to QIBs, provided that our Company with the consent of the Investor Selling Shareholders in consultation with the BRLMs and the Promoter Selling Shareholders, allocate up to 60% of the QIB Portion to Anchor Investors on a discretionary basis in accordance with the SEBI ICDR Regulations, of which one-third shall be reserved for domestic Mutual Funds, subject to valid Bids being received from domestic Mutual Funds at or above the Anchor Investor Allocation Price. In the event of under-subscription, or non-allotment in the Anchor Investor Portion, the balance Equity Shares shall be added to the Net QIB Portion. Further, 5% of the Net QIB Portion shall be available for allocation on a proportionate basis only to Mutual Funds, and the remainder of the Net QIB Portion shall be available for allocation on a proportionate basis to all QIBs (other than Anchor Investors), including Mutual Funds, subject to valid Bids being received at or above the Offer Price. Further, not less than 15% of the Offer shall be available for allocation on a proportionate basis to Non-Institutional Bidders and not less than 35% of the Offer shall be available for allocation to

Retail Individual Bidders in accordance with the SEBI ICDR Regulations, subject to valid Bids being received at or above the Offer Price (net of Retail Discount, if any).

The Offer includes a reservation of up to [●] Equity Shares, aggregating up to ₹90 million, for subscription by Eligible Employees. The Employee Reservation Portion shall not exceed [●]% of our post-Offer paid-up equity share capital subject to valid Bids being received at or above the Offer Price, net of Employee Discount, if any.

Under-subscription, if any, in any category, except in the QIB Portion, would be allowed to be met with spill over from any other category or combination of categories of Bidders at the discretion of our Company and the Investor Selling Shareholders in consultation with the BRLMs and the Promoter Selling Shareholders and the Designated Stock Exchange subject to receipt of valid Bids received at or above the Offer Price. Under-subscription, if any, in the QIB Portion, would not be allowed to be met with spill-over from any other category or a combination of categories.

The Equity Shares, on Allotment, shall be traded only in the dematerialised segment of the Stock Exchanges.

Investors must ensure that their PAN is linked with Aadhaar and are in compliance with the notification by the Central Board of Direct Taxes dated Feb 13, 2020 and press release dated June 25, 2021.

Investors should note that the Equity Shares will be Allotted to all successful Bidders only in dematerialised form. The Bid cum Application Forms which do not have the details of the Bidders' depository account, including DP ID, Client ID, PAN and UPI ID, for RIBs Bidding using the UPI Mechanism, shall be treated as incomplete and will be rejected. Bidders will not have the option of being Allotted Equity Shares in physical form. However, they may get the Equity Shares rematerialized subsequent to Allotment of the Equity Shares in the Offer, in compliance with Applicable Law.

Phased implementation of Unified Payments Interface

SEBI has issued the UPI Circulars in relation to streamlining the process of public issue of inter alia, equity shares. Pursuant to the UPI Circulars, the UPI Mechanism has been introduced in a phased manner as a payment mechanism (in addition to mechanism of blocking funds in the account maintained with SCSBs under ASBA) for applications by RIBs through Designated Intermediaries with the objective to reduce the time duration from public issue closure to listing from six Working Days to up to three Working Days. Considering the time required for making necessary changes to the systems and to ensure complete and smooth transition to the UPI payment mechanism, the UPI Circulars have introduced the UPI Mechanism in three phases in the following manner:

Phase I: This phase was applicable from January 1, 2019 until March 31, 2019 or floating of five main board public issues, whichever was later. Subsequently, the timeline for implementation of Phase I was extended till June 30, 2019. Under this phase, a RIB had the option to submit the ASBA Form with any of the Designated Intermediary and use his/ her UPI ID for the purpose of blocking of funds. The time duration from public issue closure to listing continued to be six Working Days.

Phase II: This phase has become applicable from July 1, 2019 and was to initially continue for a period of three months or floating of five main board public issues, whichever is later. SEBI vide its circular no. SEBI/HO/CFD/DCR2/CIR/P/2019/133 dated November 8, 2019 has decided to extend the timeline for implementation of UPI Phase II until March 31, 2020. Subsequently, SEBI vide its circular no. SEBI/HO/CFD/DIL2/CIR/P/2020/50 dated March 30, 2020 extended the timeline for implementation of UPI Phase II till further notice. Under this phase, submission of the ASBA Form by RIBs through Designated Intermediaries (other than SCSBs) to SCSBs for blocking of funds has been discontinued and replaced by the UPI Mechanism. However, the time duration from public issue closure to listing continues to be six Working Days during this phase.

Phase III: The commencement period of Phase III is yet to be notified. In this phase, the time duration from public issue closure to listing would be reduced to three Working Days.

For further details, refer to the General Information Document available on the websites of the Stock Exchanges and the BRLMs.

Bid cum Application Form

Copies of the Bid cum Application Form (other than for Anchor Investors) and the abridged prospectus will be available with the Designated Intermediaries at the Bidding Centres, and our Registered Office and Corporate Office. An electronic copy of the Bid cum Application Form will also be available for download on the websites of NSE (www.nseindia.com) and BSE (www.bseindia.com) at least one day prior to the Bid/Offer Opening Date.

Copies of the Anchor Investor Application Form will be available at the office of the BRLMs.

All Bidders (other than Anchor Investors) shall mandatorily participate in the Offer only through the ASBA process. Anchor Investors are not permitted to participate in the Offer through the ASBA process. The RIBs can additionally Bid through the UPI Mechanism.

RIBs Bidding using the UPI Mechanism must provide the valid UPI ID in the relevant space provided in the Bid cum Application Form and the Bid cum Application Forms that do not contain the UPI ID are liable to be rejected.

ASBA Bidders (not using the UPI Mechanism) must provide bank account details and authorisation to block funds in their respective ASBA Accounts in the relevant space provided in the ASBA Form and the ASBA Forms that do not contain such details are liable to be rejected.

ASBA Bidders shall ensure that the Bids are made on ASBA Forms bearing the stamp of the Designated Intermediary, submitted at the Bidding Centres only (except in case of electronic ASBA Forms) and the ASBA Forms not bearing such specified stamp are liable to be rejected. RIBs using UPI Mechanism, may submit their ASBA Forms, including details of their UPI IDs, with the Syndicate, sub-Syndicate members, Registered Brokers, RTAs or CDPs. RIBs authorising an SCSB to block the Bid Amount in the ASBA Account may submit their ASBA Forms with the SCSBs. ASBA Bidders must ensure that the ASBA Account has sufficient credit balance such that an amount equivalent to the full Bid Amount can be blocked by the SCSB or the Sponsor Bank, as applicable at the time of submitting the Bid. In order to ensure timely information to investors, SCSBs are required to send SMS alerts to investors intimating them about Bid Amounts blocked/ unblocked.

The prescribed colour of the Bid cum Application Form for the various categories is as follows:

Category	Colour of Bid cum Application Form*
Resident Indians, including resident QIBs, Non-Institutional Bidders, Retail Individual Bidders and Eligible NRIs applying on a non-repatriation basis	White
Eligible NRIs, FVCIs, FPIs and registered bilateral and multilateral institutions applying on a repatriation basis	Blue
Anchor Investors	White
Eligible Employees bidding in the Employee Reservation Portion	Pink

*Excluding electronic Bid cum Application Forms

Notes:

- (1) *Electronic Bid cum Application forms and the abridged prospectus will also be available for download on the website of NSE (www.nseindia.com) and BSE (www.bseindia.com)*
- (2) *Bid cum Application Forms for Anchor Investors shall be available at the office of the BRLMs*
- (3) *Bid cum Application Forms for Eligible Employees shall be available at the Registered Office and Corporate Office of the Company.*

In case of ASBA forms, the relevant Designated Intermediaries shall upload the relevant bid details in the electronic bidding system of the Stock Exchanges. For ASBA Forms (other than RIBs using UPI Mechanism) Designated Intermediaries (other than SCSBs) shall submit/ deliver the ASBA Forms to the respective SCSB where the Bidder has an ASBA bank account and shall not submit it to any non-SCSB bank or any Escrow Collection Bank.

For RIBs using UPI Mechanism, the Stock Exchanges shall share the Bid details (including UPI ID) with the Sponsor Bank on a continuous basis to enable the Sponsor Bank to initiate UPI Mandate Request to RIBs for blocking of funds. The Sponsor Bank shall initiate request for blocking of funds through NPCI to RIBs, who shall accept the UPI Mandate Request for blocking of funds on their respective mobile applications associated with UPI ID linked bank account. The NPCI shall maintain an audit trail for every bid entered in the Stock Exchanges bidding platform, and the liability to compensate RIBs (using the UPI Mechanism) in case of failed transactions shall be with the concerned entity (i.e. the Sponsor Bank, NPCI or the bankers to an issue) at whose end the lifecycle of the transaction has come to a halt. The NPCI shall share the audit trail of all disputed transactions/ investor complaints to the Sponsor Banks and the bankers to an issue. The BRLMs shall also be required to obtain the audit trail from the Sponsor Banks and the Bankers to the Offer for analysing the same and fixing liability. For ensuring timely information to investors, SCSBs shall send SMS alerts as specified in SEBI circular no. SEBI/HO/CFD/DIL2/CIR/P/2021/2480/1/M dated March 16, 2021, as amended pursuant to SEBI circular no. SEBI/HO/CFD/DIL2/P/CIR/2021/570 dated June 2, 2021.

Electronic registration of Bids

- (a) The Designated Intermediary may register the Bids using the on-line facilities of the Stock Exchanges. The Designated Intermediaries can also set up facilities for off-line electronic registration of Bids, subject to the condition that they may subsequently upload the off-line data file into the on-line facilities for Book Building on a regular basis before the closure of the Offer.
- (b) On the Bid/Offer Closing Date, the Designated Intermediaries may upload the Bids till such time as may be permitted by the Stock Exchanges and as disclosed in this Red Herring Prospectus.
- (c) Only Bids that are uploaded on the Stock Exchanges Platform are considered for allocation/Allotment. The Designated Intermediaries are given till 1:00 pm on the next Working Day following the Bid/Offer Closing Date to modify select fields uploaded in the Stock Exchange Platform during the Bid/Offer Period after which the Stock Exchange(s) send the bid information to the Registrar to the Offer for further processing.

Participation by Promoters and members of the Promoter Group of the Company and the BRLMs

The BRLM shall not be allowed to purchase Equity Shares in the Offer in any manner, except towards fulfilling their underwriting obligations. However, the associates and affiliates of the BRLMs may Bid for Equity Shares in the Offer, either in the QIB Portion or in the Non-Institutional Portion as may be applicable to such Bidders, where the allocation is on a proportionate basis and such subscription may be on their own account or on behalf of their clients. All categories of investors, including associates or affiliates of the BRLMs, shall be treated equally for the purpose of allocation to be made on a proportionate basis.

None of (i) the BRLMs or any associates of the BRLMs (except Mutual Funds sponsored by entities which are associates of the BRLMs or insurance companies promoted by entities which are associate of BRLMs or AIFs sponsored by the entities which are associate of the BRLMs or FPIs (other than individuals, corporate bodies and family offices) sponsored by the entities which are associates of the BRLMs) nor (ii) any “person related to our Promoters/ Promoter Group” shall apply in the Offer under the Anchor Investor Portion.

For the purposes of this section, a QIB who has any of the following rights shall be deemed to be a “person related to our Promoters/ Promoter Group”: (a) rights under a shareholders’ agreement or voting agreement entered into with our Promoters or Promoter Group; (b) veto rights; or (c) right to appoint any nominee director on our Board.

Further, an Anchor Investor shall be deemed to be an associate of the BRLMs, if: (a) either of them controls, directly or indirectly through its subsidiary or holding company, not less than 15% of the voting rights in the other; or (b) either of them, directly or indirectly, by itself or in combination with other persons, exercises control over the other; or (c) there is a common director, excluding a nominee director, amongst the Anchor Investor and the BRLMs.

Our Promoters and members of our Promoter Group will not participate in the Offer, except in their capacity as Selling Shareholders tendering Equity Shares in the Offer for Sale.

Bids by Mutual Funds

With respect to Bids by Mutual Funds, a certified copy of their SEBI registration certificate must be lodged along with the Bid cum Application Form. Failing this, our Company in consultation with the Selling Shareholders reserve the right to reject any Bid without assigning any reason thereof.

Bids made by asset management companies or custodians of Mutual Funds shall specifically state names of the concerned schemes for which such Bids are made.

In case of a Mutual Fund, a separate Bid can be made in respect of each scheme of the Mutual Fund registered with SEBI and such Bids in respect of more than one scheme of the Mutual Fund will not be treated as multiple Bids provided that the Bids clearly indicate the scheme concerned for which the Bid has been made.

No Mutual Fund scheme shall invest more than 10% of its NAV in equity shares or equity related instruments of any single company provided that the limit of 10% shall not be applicable for investments in case of index funds or sector or industry specific schemes. No Mutual Fund under all its schemes should own more than 10% of any company’s paid-up share capital carrying voting rights.

Bids by Eligible NRIs

Eligible NRIs may obtain copies of Bid cum Application Form from the Designated Intermediaries. Only Bids accompanied by payment in Indian Rupees or freely convertible foreign exchange will be considered for Allotment. Eligible NRI Bidders bidding on a repatriation basis by using the Non-Resident Forms should authorise their respective SCSB to block their Non-Resident External (“NRE”) accounts, or Foreign Currency Non-Resident (“FCNR”) Accounts, and eligible NRI Bidders bidding on a non-repatriation basis by using Resident Forms should authorise their respective SCSB to block their Non-Resident Ordinary (“NRO”) accounts for the full Bid Amount, at the time of the submission of the Bid cum Application Form. NRIs applying in the Offer through the UPI Mechanism are advised to enquire with the relevant bank, whether their account is UPI linked, prior to submitting a Bid cum Application Form.

Eligible NRIs Bidding on non-repatriation basis are advised to use the Bid cum Application Form for residents (white in colour). Eligible NRIs Bidding on a repatriation basis are advised to use the Bid cum Application Form meant for Non-Residents (blue in colour).

For details of investment by NRIs, see “*Restrictions on Foreign Ownership of Indian Securities*” on page 358. Participation of Eligible NRIs shall be subject to the FEMA Non-debt Instruments Rules.

Bids by HUFs

Bids by Hindu Undivided Families or HUFs, should be made in the individual name of the *Karta*. The Bidder/Applicant should specify that the Bid is being made in the name of the HUF in the Bid cum Application Form/Application Form as follows: "Name of sole or first Bidder/Applicant: XYZ Hindu Undivided Family applying through XYZ, where XYZ is the name of the *Karta*". Bids/Applications by HUFs will be considered at par with Bids/Applications from individuals.

Bids by FPIs

In case of Bids made by FPIs, a certified copy of the certificate of registration issued under the SEBI FPI Regulations is required to be attached to the Bid cum Application Form, failing which our Company in consultation with the Selling Shareholders reserve the right to reject any Bid without assigning any reason. FPIs who wish to participate in the Offer are advised to use the Bid cum Application Form for Non-Residents (Blue in colour).

To ensure compliance with the above requirement, SEBI, pursuant to its circular dated July 13, 2018, has directed that at the time of finalisation of the Basis of Allotment, the Registrar shall (i) use the PAN issued by the Income Tax Department of India for checking compliance for a single FPI; and (ii) obtain validation from Depositories for the FPIs who have invested in the Offer to ensure there is no breach of the investment limit, within the timelines for issue procedure, as prescribed by SEBI from time to time.

Bids by following FPIs, submitted with the same PAN but with different beneficiary account numbers, Client IDs and DP IDs shall not be treated as multiple Bids:

- FPIs which utilise the multi investment manager structure;
- Offshore derivative instruments which have obtained separate FPI registration for ODI and proprietary derivative investments;
- Sub funds or separate class of investors with segregated portfolio who obtain separate FPI registration;
- FPI registrations granted at investment strategy level/sub fund level where a collective investment scheme or fund has multiple investment strategies/sub-funds with identifiable differences and managed by a single investment manager;
- Multiple branches in different jurisdictions of foreign bank registered as FPIs;
- Government and Government related investors registered as Category 1 FPIs; and
- Entities registered as collective investment scheme having multiple share classes.

The Bids belonging to any of the above mentioned seven structures and having same PAN may be collated and identified as a single Bid in the Bidding process. The Equity Shares allotted in the Bid may be proportionately distributed to the applicant FPIs (with same PAN).

Subject to compliance with all applicable Indian laws, rules, regulations, guidelines and approvals in terms of Regulation 21 of the SEBI FPI Regulations, an FPI, may issue, subscribe to or otherwise deal in offshore derivative instruments (as defined under the SEBI FPI Regulations as any instrument, by whatever name called, which is issued overseas by a FPI against securities held by it in India, as its underlying) directly or indirectly, only in the event (i) such offshore derivative instruments are issued only by persons registered as Category I FPIs; (ii) such offshore derivative instruments are issued only to persons eligible for registration as Category I FPIs; (iii) such offshore derivative instruments are issued after compliance with 'know your client' norms; and (iv) such other conditions as may be specified by SEBI from time to time.

An FPI issuing offshore derivative instruments is also required to ensure that any transfer of offshore derivative instruments issued by, or on behalf of it subject to, *inter alia*, the following conditions:

- (a) such offshore derivative instruments are transferred to persons subject to fulfilment of SEBI FPI Regulations; and
- (b) prior consent of the FPI is obtained for such transfer, except when the persons to whom the offshore derivative instruments are to be transferred are pre-approved by the FPI.

The FPIs who wish to participate in the Offer are advised to use the Bid cum Application Form for non-residents.

Further, Bids received from FPIs bearing the same PAN shall be treated as multiple Bids and are liable to be rejected, except for Bids from FPIs that utilize the multiple investment manager structure in accordance with the Operational Guidelines for FPIs and Designated Depository Participants issued to facilitate implementation of SEBI FPI Regulations (such structure referred to as "**MIM Structure**"), provided such Bids have been made with different beneficiary account numbers, Client IDs and DP IDs. Accordingly, it should be noted that multiple Bids received from FPIs, who do not utilize the MIM Structure, and bear the same PAN, are liable to be rejected. In order to ensure valid Bids, FPIs making multiple Bids using the same PAN,

and with different beneficiary account numbers, Client IDs and DP IDs, are required to provide a confirmation in the Bid cum Application Forms that the relevant FPIs making multiple Bids utilize the MIM Structure and indicate the names of their respective investment managers in such confirmations. In the absence of such confirmation from the relevant FPIs, such multiple Bids shall be rejected.

For details of investment by FPIs, see “*Restrictions on Foreign Ownership of Indian Securities*” on page 358. Participation of FPIs shall be subject to the FEMA Non-debt Instruments Rules.

All non-resident investors should note that refunds (in case of Anchor Investors), dividends and other distributions, if any, will be payable in Indian Rupees only and net of bank charges and commission.

Bids by SEBI registered VCFs, AIFs and FVCIs

The SEBI VCF Regulations and the SEBI FVCI Regulations prescribe, among other things, the investment restrictions on VCFs and FVCIs registered with SEBI. While the SEBI VCF Regulations have since been repealed, the funds registered as VCFs under the SEBI VCF Regulations continue to be regulated by such regulations till the existing fund or scheme managed by the fund is wound up. The holding in any company by any individual VCF or FVCIs registered with SEBI should not exceed 25% of the corpus of the VCF or FVCI. Further, VCFs and FVCIs can invest only up to 33.33% of the investible funds in various prescribed instruments, including in public offering.

Further, the SEBI AIF Regulations prescribe, among other things, the investment restrictions on AIFs. Category I and II AIFs cannot invest more than 25% of the investible funds in one investee company directly or through investment in the units of other Alternative Investment Funds. A Category III AIF cannot invest more than 10% of the investible funds in one investee company directly or through investment in the units of other Alternative Investment Funds. A VCF registered as a Category I AIF, as defined in the SEBI AIF Regulations, cannot invest more than one-third of its investible funds by way of subscription to an initial public offering of a venture capital undertaking. Additionally, the VCFs which have not re-registered as an AIF under the SEBI AIF Regulations shall continue to be regulated by the SEBI VCF Regulations until the existing fund or scheme managed by the fund is wound up.

All non-resident investors should note that refunds (in case of Anchor Investors), dividends and other distributions, if any, will be payable in Indian Rupees only and net of bank charges and commission.

Our Company or the BRLMs will not be responsible for loss, if any, incurred by the Bidder on account of conversion of foreign currency.

Bids by Eligible Employees

Bids under Employee Reservation Portion by Eligible Employees shall be:

- (a) Made only in the prescribed Bid cum Application Form or Revision Form (i.e. pink colour form).
- (b) The Bid must be for a minimum of [●] Equity Shares and in multiples of [●] Equity Shares thereafter so as to ensure that the Bid Amount payable by the Eligible Employee does not exceed ₹500,000 (net of Employee Discount). However, a Bid by an Eligible Employee in the Employee Reservation Portion will be considered for allocation, in the first instance, for a Bid amounting up to ₹200,000 (net of Employee Discount). In the event of any under-subscription in the Employee Reservation Portion, the unsubscribed portion will be available for allocation and Allotment, proportionately to all Eligible Employees, who have bid in excess of ₹200,000 (net of Employee Discount), provided however that the maximum Bid in this category by an Eligible Employee cannot exceed ₹500,000 (net of Employee Discount).
- (c) The Bidder should be an Eligible Employee as defined above. In case of joint bids, the first Bidder shall be an Eligible Employee.
- (d) Only Eligible Employees would be eligible to apply in this Offer under the Employee Reservation Portion.
- (e) Only those Bids, which are received at or above the Offer Price, would be considered for allocation under this category.
- (f) Eligible Employees can apply at Cut-off Price.
- (g) Bids by Eligible Employees can be made also in the “Net Offer to the Public” and such Bids shall not be treated as multiple Bids.
- (h) If the aggregate demand in this category is less than or equal to [●] Equity Shares at or above the Offer Price, full allocation shall be made to the Eligible Employees to the extent of their demand.

- (i) Under-subscription, if any, in the Employee Reservation Portion will be added back to the Net Offer.

In case of under-subscription in the Net Offer, spill over to the extent of under-subscription shall be permitted from the Employee Reservation Portion subject to the Net Offer constituting [●]% of the post-Offer share capital of our Company. If the aggregate demand in this category is greater than [●] Equity Shares at or above the Offer Price, the allocation shall be made on a proportionate basis.

Bids by limited liability partnerships

In case of Bids made by limited liability partnerships registered under the Limited Liability Partnership Act, 2008, a certified copy of certificate of registration issued under the Limited Liability Partnership Act, 2008, must be attached to the Bid cum Application Form. Failing this, our Company in consultation with the Selling Shareholders reserve the right to reject any Bid without assigning any reason thereof.

Bids by banking companies

In case of Bids made by banking companies registered with RBI, certified copies of: (i) the certificate of registration issued by RBI, and (ii) the approval of such banking company's investment committee are required to be attached to the Bid cum Application Form, failing which our Company in consultation with the Selling Shareholders reserve the right to reject any Bid without assigning any reason.

The investment limit for banking companies in non-financial services companies as per the Banking Regulation Act, 1949, as amended, (the "Banking Regulation Act"), and the Master Directions - Reserve Bank of India (Financial Services provided by Banks) Directions, 2016, as amended, is 10% of the paid-up share capital of the investee company, not being its subsidiary engaged in non-financial services, or 10% of the bank's own paid-up share capital and reserves, whichever is lower. Further, the aggregate investment by a banking company in subsidiaries and other entities engaged in financial services cannot exceed 20% of the investee company's paid up share capital and reserves. However, a banking company would be permitted to invest in excess of 10% but not exceeding 30% of the paid-up share capital of such investee company if (i) the investee company is engaged in non-financial activities permitted for banks in terms of Section 6(1) of the Banking Regulation Act, or (ii) the additional acquisition is through restructuring of debt/corporate debt restructuring/strategic debt restructuring, or to protect the bank's interest on loans/investments made to a company. The bank is required to submit a time-bound action plan for disposal of such shares within a specified period to the RBI. A banking company would require a prior approval of the RBI to make (i) investment in excess of 30% of the paid-up share capital of the investee company, (ii) investment in a subsidiary and a financial services company that is not a subsidiary (with certain exceptions prescribed), and (iii) investment in a non-financial services company in excess of 10% of such investee company's paid-up share capital as stated in 5(a)(v)(c)(i) of the Reserve Bank of India (Financial Services provided by Banks) Directions, 2016, as amended.

Bids by SCSBs

SCSBs participating in the Offer are required to comply with applicable law, including the terms of the SEBI circulars (Nos. CIR/CFD/DIL/12/2012 and CIR/CFD/DIL/1/2013) dated September 13, 2012 and January 2, 2013. Such SCSBs are required to ensure that for making applications on their own account using ASBA, they should have a separate account in their own name with any other SEBI registered SCSBs. Further, such account shall be used solely for the purpose of making application in public issues and clear demarcated funds should be available in such account for such applications.

Bids by insurance companies

In case of Bids made by insurance companies registered with the IRDAI, a certified copy of certificate of registration issued by IRDAI must be attached to the Bid cum Application Form. Failing this, our Company in consultation with the Selling Shareholders reserve the right to reject any Bid without assigning any reason thereof.

The exposure norms for insurers, prescribed under the Insurance Regulatory and Development Authority of India (Investment) Regulations, 2016, as amended, are broadly set forth below:

- (a) equity shares of a company: the lower of 10%* of the outstanding equity shares (face value) or 10% of the respective fund in case of life insurer or 10% of investment assets in case of general insurer or reinsurer or health insurer;
- (b) the entire group of the investee company: not more than 15% of the respective fund in case of a life insurer or 15% of investment assets in case of a general insurer or reinsurer or health insurer or 15% of the investment assets in all companies belonging to the group, whichever is lower; and
- (c) the industry sector in which the investee company operates: not more than 15% of the fund of a life insurer or a general insurer or a reinsurer or health insurer or 15% of the investment asset, whichever is lower.

The maximum exposure limit, in the case of an investment in equity shares, cannot exceed the lower of an amount of 10% of

the investment assets of a life insurer or general insurer and the amount calculated under (a), (b) and (c) above, as the case may be.

**The above limit of 10% shall stand substituted as 15% of outstanding equity shares (face value) for insurance companies with investment assets of ₹2,500,000 million or more and 12% of outstanding equity shares (face value) for insurers with investment assets of ₹500,000 million or more but less than ₹2,500,000 million.*

Insurance companies participating in the Offer shall comply with all applicable regulations, guidelines and circulars issued by IRDAI from time to time.

Bids by provident funds/pension funds

In case of Bids made by provident funds/pension funds, subject to applicable laws, with minimum corpus of ₹250 million, a certified copy of a certificate from a chartered accountant certifying the corpus of the provident fund/pension fund must be attached to the Bid cum Application Form. Failing this, our Company in consultation with the Selling Shareholders reserves the right to reject any Bid, without assigning any reason thereof.

Bids under Power of Attorney

In case of Bids made pursuant to a power of attorney or by limited companies, corporate bodies, registered societies, Eligible FPIs, AIFs, Mutual Funds, insurance companies, insurance funds set up by the army, navy or air force of the India, insurance funds set up by the Department of Posts, India or the National Investment Fund and provident funds with a minimum corpus of ₹250 million (subject to applicable law) and pension funds with a minimum corpus of ₹250 million, a certified copy of the power of attorney or the relevant resolution or authority, as the case may be, along with a certified copy of the memorandum of association and articles of association and/or bye laws must be lodged along with the Bid cum Application Form. Failing this, our Company in consultation with the Selling Shareholders reserve the right to accept or reject any Bid in whole or in part, in either case, without assigning any reason thereof.

Our Company in consultation with the Selling Shareholders in their absolute discretion, reserve the right to relax the above condition of simultaneous lodging of the power of attorney along with the Bid cum Application Form subject to the terms and conditions that our Company and Selling Shareholders in consultation with the BRLMs may deem fit.

Bids by Systemically Important Non-Banking Financial Companies

In case of Bids made by Systemically Important NBFCs registered with RBI, certified copies of: (i) the certificate of registration issued by RBI, (ii) certified copy of its last audited financial statements on a standalone basis and a net worth certificate from its statutory auditor, and (iii) such other approval as may be required by the Systemically Important NBFCs, are required to be attached to the Bid cum Application Form. Failing this, our Company in consultation with the Selling Shareholders, reserve the right to reject any Bid without assigning any reason thereof. Systemically Important NBFCs participating in the Offer shall comply with all applicable regulations, guidelines and circulars issued by RBI from time to time.

The investment limit for Systemically Important NBFCs shall be as prescribed by RBI from time to time.

In accordance with existing regulations issued by the RBI, OCBs cannot participate in the Offer.

The above information is given for the benefit of the Bidders. Our Company, the Selling Shareholders and the BRLMs are not liable for any amendments or modification or changes in applicable laws or regulations, which may occur after the date of this Red Herring Prospectus. Bidders are advised to make their independent investigations and ensure that any single Bid from them does not exceed the applicable investment limits or maximum number of the Equity Shares that can be held by them under applicable law or regulation or as specified in this Red Herring Prospectus and the Prospectus.

General Instructions

Do's:

1. Check if you are eligible to apply as per the terms of this Red Herring Prospectus and under applicable law, rules, regulations, guidelines and approvals. All Bidders (other than Anchor Investors) should submit their Bids through the ASBA process only;
2. Ensure that you have Bid within the Price Band;
3. Read all the instructions carefully and complete the Bid cum Application Form, as the case may be, in the prescribed form;

4. Ensure that you (other than in the case of Anchor Investors) have mentioned the correct ASBA Account number if you are not an RIB using the UPI Mechanism in the Bid cum Application Form and if you are an RIB using the UPI Mechanism ensure that you have mentioned the correct UPI ID (with maximum length of 45 characters including the handle), in the Bid cum Application Form;
5. RIBs using UPI Mechanism through the SCSBs and mobile applications shall ensure that the name of the bank appears in the list of SCSBs which are live on UPI, as displayed on the SEBI website. RIBs shall ensure that the name of the app and the UPI handle which is used for making the application appears in Annexure 'A' to the SEBI circular no. SEBI/HO/CFD/DIL2/COR/P/2019/85 dated July 26, 2019;
6. Ensure that your Bid cum Application Form bearing the stamp of a Designated Intermediary is submitted to the Designated Intermediary at the Bidding Centre within the prescribed time;
7. Ensure that you have funds equal to the Bid Amount in the ASBA Account maintained with the SCSB, before submitting the ASBA Form to any of the Designated Intermediaries;
8. RIBs using UPI Mechanism, may submit their ASBA Forms with the Syndicate, Registered Brokers, RTAs or CDPs and should ensure that the ASBA Form contains the stamp of such Designated Intermediary;
9. Ensure that the signature of the First Bidder in case of joint Bids, is included in the Bid cum Application Forms;
10. Ensure that you request for and receive a stamped acknowledgement counterfoil of the Bid cum Application Form for all your Bid options from the concerned Designated Intermediary;
11. Ensure that the name(s) given in the Bid cum Application Form is/are exactly the same as the name(s) in which the beneficiary account is held with the Depository Participant. In case of joint Bids, the Bid cum Application Form should contain only the name of the First Bidder whose name should also appear as the first holder of the beneficiary account held in joint names. Ensure that the signature of the First Bidder is included in the Bid cum Application Forms;
12. RIBs Bidding in the Offer to ensure that they shall use only their own ASBA Account or only their own bank account linked UPI ID which is UPI 2.0 certified by NPCI (only for RIBs using the UPI Mechanism) to make an application in the Offer and not ASBA Account or bank account linked UPI ID of any third party;
13. Ensure that you submit the revised Bids to the same Designated Intermediary, through whom the original Bid was placed and obtain a revised acknowledgment;
14. Retail Individual Bidders not using the UPI Mechanism, should submit their Bid cum Application Form directly with SCSBs and/or the designated branches of SCSBs;
15. Ensure that you have correctly signed the authorisation/undertaking box in the Bid cum Application Form, or have otherwise provided an authorisation to the SCSB or Sponsor Bank, as applicable, via the electronic mode, for blocking funds in the ASBA Account equivalent to the Bid Amount mentioned in the Bid cum Application Form, as the case may be, at the time of submission of the Bid. In case of RIBs submitting their Bids and participating in the Offer through the UPI Mechanism, ensure that you authorise the UPI Mandate Request raised by the Sponsor Bank for blocking of funds equivalent to Bid Amount and subsequent debit of funds in case of Allotment;
16. Except for Bids (i) on behalf of the Central or State Governments and the officials appointed by the courts, who, in terms of the SEBI circular no. MRD/DoP/Cir-20/2008 dated June 30, 2008, may be exempt from specifying their PAN for transacting in the securities market, (ii) submitted by investors who are exempt from the requirement of obtaining/specifying their PAN for transacting in the securities market, and (iii) Bids by persons resident in the state of Sikkim, who, in terms of a SEBI circular dated July 20, 2006, may be exempted from specifying their PAN for transacting in the securities market, all Bidders should mention their PAN allotted under the IT Act. The exemption for the Central or the State Government and officials appointed by the courts and for investors residing in the State of Sikkim is subject to (a) the Demographic Details received from the respective depositories confirming the exemption granted to the beneficiary owner by a suitable description in the PAN field and the beneficiary account remaining in "active status"; and (b) in the case of residents of Sikkim, the address as per the Demographic Details evidencing the same. All other applications in which PAN is not mentioned will be rejected;
17. Ensure that the Demographic Details are updated, true and correct in all respects;
18. Ensure that thumb impressions and signatures other than in the languages specified in the Eighth Schedule to the Constitution of India are attested by a Magistrate or a Notary Public or a Special Executive Magistrate under official seal;
19. Ensure that the category and the investor status is indicated in the Bid cum Application Form;

20. Ensure that in case of Bids under power of attorney or by limited companies, corporates, trust, etc., relevant documents are submitted;
21. Ensure that Bids submitted by any person resident outside India is in compliance with applicable foreign and Indian laws;
22. Since the Allotment will be in demat form only, ensure that the Bidder's depository account is active, the correct DP ID, Client ID, the PAN, UPI ID, if applicable, are mentioned in their Bid cum Application Form and that the name of the Bidder, the DP ID, Client ID, the PAN and UPI ID, if applicable, entered into the online IPO system of the Stock Exchanges by the relevant Designated Intermediary, as applicable, matches with the name, DP ID, Client ID, PAN and UPI ID, if applicable, available in the Depository database;
23. Ensure that when applying in the Offer using UPI, the name of your SCSB appears in the list of SCSBs displayed on the SEBI website which are live on UPI. Further, also ensure that the name of the app and the UPI handle being used for making the application is also appearing in Annexure 'A' to the SEBI circular no. SEBI/HO/CFD/DIL2/CIR/P/2019/85 dated July 26, 2019;
24. RIBs who wish to revise their Bids using the UPI Mechanism, should submit the revised Bid with the Designated Intermediaries, pursuant to which RIBs should ensure acceptance of the UPI Mandate Request received from the Sponsor Bank to authorise blocking of funds equivalent to the revised Bid Amount in the RIB's ASBA Account;
25. Anchor Investors should submit the Anchor Investor Application Forms to the BRLMs;
26. Ensure that you have accepted the UPI Mandate Request received from the Sponsor Bank prior to 12:00 p.m. of the Working Day immediately after the Bid/ Offer Closing Date;
27. FPIs making MIM Bids using the same PAN, and different beneficiary account numbers, Client IDs and DP IDs, are required to submit a confirmation that their Bids are under the MIM structure and indicate the name of their investment managers in such confirmation which shall be submitted along with each of their Bid cum Application Forms. In the absence of such confirmation from the relevant FPIs, such MIM Bids shall be rejected;
28. RIBs shall ensure that details of the Bid are reviewed and verified by opening the attachment in the UPI Mandate Request and then proceed to authorise the UPI Mandate Request using his/her UPI PIN. Upon the authorisation of the mandate using his/her UPI PIN, an RIB may be deemed to have verified the attachment containing the application details of the RIB in the UPI Mandate Request and have agreed to block the entire Bid Amount and authorised the Sponsor Bank to block the Bid Amount mentioned in the Bid Cum Application Form; and
29. Ensure that while Bidding through a Designated Intermediary, the Bid cum Application Form (other than for Anchor Investors and RIBs bidding using the UPI Mechanism) is submitted to a Designated Intermediary in a Bidding Centre and that the SCSB where the ASBA Account, as specified in the ASBA Form, is maintained has named at least one branch at that location for the Designated Intermediary to deposit ASBA Forms (a list of such branches is available on the website of SEBI at www.sebi.gov.in).

The Bid cum Application Form is liable to be rejected if the above instructions, as applicable, are not complied with. Application made using incorrect UPI handle or using a bank account of an SCSB or SCSBs which is not mentioned in the Annexure 'A' to the SEBI circular no. SEBI/HO/CFD/DIL2/CIR/P/2019/85 dated July 26, 2019 is liable to be rejected.

Don'ts:

1. Do not Bid for lower than the minimum Bid size;
2. Do not Bid for a Bid Amount exceeding ₹200,000, net of Retail Discount, if any (for Bids by Retail Individual Bidders) and ₹500,000, net of Employee Discount, if any (for Bids by Eligible Employees);
3. Do not pay the Bid Amount in cheques, demand drafts or by cash, money order, postal order or by stock invest;
4. Do not send Bid cum Application Forms by post; instead submit the same to the Designated Intermediary only;
5. Do not Bid at Cut-off Price (for Bids by QIBs and Non-Institutional Bidders);
6. Do not instruct your respective banks to release the funds blocked in the ASBA Account under the ASBA process;
7. Do not submit the Bid for an amount more than funds available in your ASBA account.
8. Do not submit Bids on plain paper or on incomplete or illegible Bid cum Application Forms or on Bid cum Application Forms in a colour prescribed for another category of a Bidder;

9. In case of ASBA Bidders, do not submit more than one ASBA Forms per ASBA Account;
10. If you are a RIB and are using UPI mechanism, do not submit more than one ASBA Form for each UPI ID;
11. Anchor Investors should not Bid through the ASBA process;
12. Do not submit the ASBA Forms to any Designated Intermediary that is not authorised to collect the relevant ASBA Forms or to our Company;
13. Do not Bid on a Bid cum Application Form that does not have the stamp of the relevant Designated Intermediary;
14. Do not submit the General Index Register (GIR) number instead of the PAN;
15. Do not submit incorrect details of the DP ID, Client ID, PAN and UPI ID, if applicable, or provide details for a beneficiary account which is suspended or for which details cannot be verified by the Registrar to the Offer;
16. Do not submit a Bid in case you are not eligible to acquire Equity Shares under applicable law or your relevant constitutional documents or otherwise;
17. Do not Bid if you are not competent to contract under the Indian Contract Act, 1872 (other than minors having valid depository accounts as per Demographic Details provided by the depository);
18. Do not submit a Bid/revise a Bid Amount, with a price less than the Floor Price or higher than the Cap Price;
19. Do not submit a Bid using UPI ID, if you are not a RIB;
20. Do not Bid on another ASBA Form or the Anchor Investor Application Form, as the case may be, after you have submitted a Bid to any of the Designated Intermediaries;
21. Do not Bid for Equity Shares in excess of what is specified for each category;
22. Do not fill up the Bid cum Application Form such that the Equity Shares Bid for, exceeds the Offer size and/or investment limit or maximum number of the Equity Shares that can be held under applicable laws or regulations or maximum amount permissible under applicable laws or regulations, or under the terms of this Red Herring Prospectus;
23. Do not withdraw your Bid or lower the size of your Bid (in terms of quantity of the Equity Shares or the Bid Amount) at any stage, if you are a QIB or a Non-Institutional Bidder. Retail Individual Bidders and Eligible Employees Bidding in the Employee Reservation Portion can revise or withdraw their Bids on or before the Bid/ Offer Closing Date;
24. Do not submit Bids to a Designated Intermediary at a location other than the Bidding Centres;
25. If you are an RIB which is submitting the ASBA Form with any of the Designated Intermediaries and using your UPI ID for the purpose of blocking of funds, do not use any third party bank account or third party linked bank account UPI ID;
26. Do not link the UPI ID with a bank account maintained with a bank that is not UPI 2.0 certified by the NPCI in case of Bids submitted by RIBs using the UPI Mechanism;
27. Do not submit more than one Bid cum Application Form for each UPI ID in case of RIBs Bidding using the UPI Mechanism;
28. Do not submit a Bid cum Application Form with a third-party UPI ID or using a third party bank account (in case of Bids submitted by Retail Individual Bidders using the UPI Mechanism);
29. RIBs Bidding through the UPI Mechanism using the incorrect UPI handle or using a bank account of an SCSB or bank which is not mentioned in the list provided on the SEBI website is liable to be rejected; and
30. Do not Bid if you are an OCB.

The Bid cum Application Form is liable to be rejected if the above instructions, as applicable, are not complied with.

Further, in case of any pre-Offer or post Offer related issues regarding share certificates/demat credit/refund orders/unblocking etc., investors can reach out to our Company Secretary and Compliance Officer. For details of our Company Secretary and Compliance Officer, see “*General Information*” on page 61.

For helpline details of the BRLMs pursuant to the SEBI/HO.CFD.DIL2/CIR/P/2021/2480/1/M dated March 16, 2021, see

“General Information -Book Running Lead Manager” on page 62.

Names of entities responsible for finalising the basis of allotment in a fair and proper manner

The authorised employees of the Designated Stock Exchange, along with the BRLMs and the Registrar, shall ensure that the Basis of Allotment is finalised in a fair and proper manner in accordance with the procedure specified in SEBI ICDR Regulations.

Method of allotment as may be prescribed by SEBI from time to time

Our Company will not make any allotment in excess of the Equity Shares through this Red Herring Prospectus and the Prospectus except in case of oversubscription for the purpose of rounding off to make allotment, in consultation with the Designated Stock Exchange.

The allotment of Equity Shares to applicants other than to the Retail Individual Bidders and Anchor Investors shall be on a proportionate basis within the respective investor categories and the number of securities allotted shall be rounded off to the nearest integer, subject to minimum allotment being equal to the minimum application size as determined and disclosed.

The allotment of Equity Shares to each Retail Individual Bidders shall not be less than the minimum bid lot, subject to the availability of shares in Retail Individual Bidders Portion, and the remaining available Equity Shares, if any, shall be allotted on a proportionate basis.

Payment into Escrow Account(s) for Anchor Investors

Our Company with the consent of the Investor Selling Shareholders in consultation with the BRLMs and the Promoter Selling Shareholders, in their absolute discretion, will decide the list of Anchor Investors to whom the CAN will be sent, pursuant to which the details of the Equity Shares allocated to them in their respective names will be notified to such Anchor Investors. For Anchor Investors, the payment instruments for payment into the Escrow Account(s) should be drawn in favour of:

- (a) In case of resident Anchor Investors: “SANSERA ENGINEERING LTD-ANCHOR R ”
- (b) In case of Non-Resident Anchor Investors: “SANSERA ENGINEERING LTD - ANCHOR NR”

Anchor Investors should note that the escrow mechanism is not prescribed by SEBI and has been established as an arrangement between our Company, the Selling Shareholders and the Syndicate, the Escrow Collection Bank and the Registrar to the Offer to facilitate collections of Bid amounts from Anchor Investors.

Pre-Offer Advertisement

Subject to Section 30 of the Companies Act, 2013, our Company shall, after filing this Red Herring Prospectus with the RoC, publish a pre- Offer advertisement, in the form prescribed by the SEBI ICDR Regulations, in: (i) all editions of Financial Express, an English national daily newspaper, Delhi edition of Jansatta, a Hindi national daily newspaper and Bangalore edition of Vishwavani a Kannada national daily newspaper, Kannada being the regional language of Karnataka, where our Registered Office and Corporate Office is located, each with wide circulation.

In the pre-Offer advertisement, we shall state the Bid/Offer Opening Date and the Bid/ Offer Closing Date. This advertisement, subject to the provisions of Section 30 of the Companies Act, 2013, shall be in the format prescribed in Part A of Schedule X of the SEBI ICDR Regulations.

The above information is given for the benefit of the Bidders/applicants. Our Company, the Selling Shareholders and the Syndicate are not liable for any amendments or modification or changes in applicable laws or regulations, which may occur after the date of this Red Herring Prospectus. Bidders/applicants are advised to make their independent investigations and ensure that the number of Equity Shares Bid for do not exceed the prescribed limits under applicable laws or regulations.

Signing of the Underwriting Agreement and the RoC Filing

- (a) Our Company, the Selling Shareholders and the Underwriters intend to enter into an Underwriting Agreement on or immediately after the finalisation of the Offer Price but prior to the filing of Prospectus.
- (b) After signing the Underwriting Agreement, an updated Red Herring Prospectus will be filed with the RoC in accordance with applicable law, which then would be termed as the ‘Prospectus’. The Prospectus will contain details of the Offer Price, the Anchor Investor Offer Price, Offer size, and underwriting arrangements and will be complete in all material respects.

Undertakings by our Company

Our Company undertakes the following:

- adequate arrangements shall be made to collect all Bid cum Application Forms submitted by Bidders (including Anchor Investor Application Form from Anchor Investors);
- the complaints received in respect of the Offer shall be attended to by our Company expeditiously and satisfactorily;
- all steps for completion of the necessary formalities for listing and commencement of trading at all the Stock Exchanges where the Equity Shares are proposed to be listed shall be taken within six Working Days of the Bid/Offer Closing Date or such other period as may be prescribed by the SEBI;
- if Allotment is not made within the prescribed time period under applicable law, the entire subscription amount received will be refunded/unblocked within the time prescribed under applicable law. If there is delay beyond the prescribed time, our Company shall pay interest prescribed under the Companies Act, 2013, the SEBI ICDR Regulations and applicable law for the delayed period;
- the funds required for making refunds (to the extent applicable) as per the mode(s) disclosed shall be made available to the Registrar to the Offer by our Company;
- where refunds (to the extent applicable) are made through electronic transfer of funds, a suitable communication shall be sent to the applicant within the time prescribed under applicable law, giving details of the bank where refunds shall be credited along with amount and expected date of electronic credit of refund;
- except for Equity Shares that may be allotted pursuant to the exercise of employee stock options granted under the ESOP 2021, no further issue of the Equity Shares shall be made till the Equity Shares offered through the Red Herring Prospectus are listed or until the Bid monies are unblocked in ASBA Account/refunded on account of non-listing, under-subscription, etc.
- Our Company and Selling Shareholders in consultation with the BRLMs, reserve the right not to proceed with the Offer, in whole or in part thereof, to the extent of the Offered Shares, after the Bid/ Offer Opening Date but before the Allotment. In such an event, our Company would issue a public notice in the newspapers in which the pre-Offer advertisements were published, within two days of the Bid/ Offer Closing Date or such other time as may be prescribed by SEBI, providing reasons for not proceeding with the Offer and inform the Stock Exchanges promptly on which the Equity Shares are proposed to be listed.
- If our Company and Selling Shareholders in consultation with the BRLMs withdraw the Offer after the Bid/ Offer Closing Date and thereafter determines that it will proceed with an issue of the Equity Shares, our Company shall file a fresh draft red herring prospectus with SEBI.

Undertakings by each of the Selling Shareholders

Each of the Selling Shareholders, severally and not jointly, confirm and undertakes in respect of itself as a 'selling shareholder' and its respective portion of the Offered Shares that:

- it is the legal and beneficial owner of the Offered Shares;
- its Offered Shares are eligible for being offered in the Offer for Sale in terms of Regulation 8 of the SEBI ICDR Regulations;
- except as set out in "*Capital Structure*" on page 68, its Offered Shares are free and clear of any pre-emptive rights, liens, mortgages, charges, pledges or any other encumbrances and shall be in dematerialised form at the time of transfer;
- it shall deposit its Offered Shares in an escrow demat in accordance with the share escrow agreement to be executed between the parties to such share escrow agreement;
- that it shall provide such reasonable assistance to our Company and the BRLMs in redressal of such investor grievances that pertain to its Offered Shares;
- it shall provide such reasonable cooperation to our Company in relation to its Offered Shares for the completion of the necessary formalities for listing and commencement of trading at the Stock Exchanges; and
- it shall not have recourse to the proceeds of the Offer until final approval for trading of the Equity Shares from the Stock Exchanges has been received.

Utilisation of Offer Proceeds

- Our Board of Directors certifies and declares that all monies received out of the Offer shall be credited/transferred to a separate bank account other than the bank account referred to in sub-section 3 of Section 40 of the Companies Act, 2013. Each of the Selling Shareholders, severally and not jointly, specifically undertake that all monies received out of the Offer shall be credited/transferred to a separate bank account other than the bank account referred to in sub-section 3 of Section 40 of the Companies Act.

RESTRICTIONS ON FOREIGN OWNERSHIP OF INDIAN SECURITIES

Foreign investment in Indian securities is regulated through the Industrial Policy, 1991 of the Government of India and FEMA. While the Industrial Policy, 1991 prescribes the limits and the conditions subject to which foreign investment can be made in different sectors of the Indian economy, FEMA regulates the precise manner in which such investment may be made. Under the Industrial Policy, unless specifically restricted, foreign investment is freely permitted in all sectors of the Indian economy up to any extent and without any prior approvals, but the foreign investor is required to follow certain prescribed procedures for making such investment. The RBI and the concerned ministries/departments are responsible for granting approval for foreign investment. The Government has from time to time made policy pronouncements on foreign direct investment (“**FDI**”) through press notes and press releases. The DPIIT, issued the Consolidated FDI Policy Circular of 2020 (“**FDI Policy**”), which, with effect from October 15, 2020 consolidated and superseded all previous press notes, press releases, circulars and clarifications on FDI issued by DPIIT that were in force and effect as on October 15, 2020. The FDI Policy will be valid until the DPIIT issues an updated circular.

The transfer of shares between an Indian resident and a non-resident does not require the prior approval of the RBI, provided that (i) the activities of the investee company are under the automatic route under the FDI Policy and transfer does not attract the provisions of the Takeover Regulations; (ii) the non-resident shareholding is within the sectoral limits under the FDI policy; and (iii) the pricing is in accordance with the guidelines prescribed by the SEBI/RBI.

As per the existing policy of the Government of India, OCBs cannot participate in the Offer.

Foreign Exchange Laws

The foreign investment in our Company is governed by *inter alia* the FEMA, as amended, the FEMA Non-debt Instruments Rules, the FDI Policy issued and amended by way of press notes.

Our Company is engaged in the manufacturing sector. Currently, foreign direct investment in the manufacturing sector is up to 100% under the automatic route. In terms of the FEMA Non-debt Instruments Rules, a person resident outside India may make investments into India, subject to certain terms and conditions, and provided that an entity of a country, which shares land border with India or the beneficial owner of an investment into India who is situated in or is a citizen of any such country, shall invest only with government approval.

Further, in accordance with Press Note No. 3 (2020 Series), dated April 17, 2020 issued by the DPIIT and the FEMA Non-Debt Instruments Rules, any investment, subscription, purchase or sale of equity instruments by entities of a country which shares land border with India or where the beneficial owner of an investment into India is situated in or is a citizen of any such country, will require prior approval of the Government of India, as prescribed in the FDI Policy and the FEMA Non-Debt Instruments Rules. Further, in the event of transfer of ownership of any existing or future foreign direct investment in an entity in India, directly or indirectly, resulting in the beneficial ownership falling within the aforesaid restriction/ purview, such subsequent ownership of any existing or future foreign direct investment in an entity in India, directly or indirectly, resulting in the beneficial ownership falling within the aforesaid restriction/purview, such subsequent change in the beneficial ownership will also require approval of the Government of India. Each Bidder should seek independent legal advice about its ability to participate in the Offer. In the event such prior approval of the Government of India is required, and such approval has been obtained, the Bidder shall intimate our Company and the Registrar in writing about such approval along with a copy thereof within the Offer Period.

Investment by Eligible NRIs

- (i) In accordance with the FEMA Non-Debt Instruments Rules, the total holding by any individual NRI, on a repatriation basis, shall not exceed 5% of the total paid-up equity capital on a fully diluted basis or shall not exceed 5% of the paid-up value of each series of debentures or preference shares or share warrants issued by an Indian company and the total holdings of all NRIs and OCIs put together, on a repatriation or non-repatriation basis, shall not exceed 10% of the total paid-up equity capital on a fully diluted basis or shall not exceed 10% of the paid-up value of each series of debentures or preference shares or share warrant. Provided that the aggregate ceiling of 10% may be raised to 24% if a special resolution to that effect is passed by the general body of the Indian company.
- (ii) Our Company has, pursuant to a Board resolution dated July 27, 2018 and Shareholders resolution dated July 28, 2018, increased the limit of investment of NRIs on a repatriation basis under Schedule III of the FEMA Non-Debt Instruments Rules to up to 24% of the paid-up equity share capital of our Company, provided that the shareholding of each NRI in the Company shall not exceed 5% of the equity share capital or such other limit as may be stipulated by the RBI.

Investment by FPIs

In terms of the SEBI FPI Regulations, the investment in Equity Shares by a single FPI or an investor group (which means multiple entities registered as FPIs and directly or indirectly having common ownership of more than 50% or common control) must be below 10% of our post-Offer equity share capital. Further, in terms of the FEMA Non-debt Instruments Rules, the total

holding by each FPI or an investor group shall be below 10% of the total paid-up equity share capital of our Company and the total holdings of all FPIs put together can be up to the sectoral cap applicable to the sector in which our Company operates (i.e., up to 100%), as prescribed under the FEMA Non-debt Instruments Rules.

In case the total holding of an FPI increases beyond 10% of the total paid-up equity share capital, on a fully diluted basis or 10% or more of the paid-up value of any series of debentures or preference shares or share warrants issued that may be issued by our Company, the total investment made by the FPI will be re-classified as FDI subject to the conditions as specified by SEBI and the RBI in this regard and our Company and the investor will be required to comply with applicable reporting requirements.

The above information is given for the benefit of the Bidders. Our Company and the BRLMs are not liable for any amendments or modification or changes in applicable laws or regulations that, may occur after the date of this Red Herring Prospectus. Bidders are advised to make their independent investigations and ensure that the number of Equity Shares Bid for do not exceed the applicable limits under laws or regulations.

SECTION VIII: DESCRIPTION OF EQUITY SHARES AND TERMS OF ARTICLES OF ASSOCIATION

Capitalized terms used in this section have the meanings that have been given to such terms in the Articles of Association of our Company. The Articles of Association of the Company comprise of two parts, Part A and Part B, which parts shall, unless the context otherwise requires, co-exist with each other. In case of inconsistency between Part A and Part B, the provisions of Part B shall be applicable. However, other than the definitions of Inflow, Investor Benchmark Rate, IRR, Outflow and Tax under Article 2.1, and Article 18 of Part B (“Surviving Articles”), Part B of the Articles of Association shall automatically terminate and cease to have any force and effect from the date of listing of equity shares of the Company on a recognized stock exchange in India pursuant to an initial public offering of the Equity Shares of the Company, without any further action, including any corporate action, by the Company or by the shareholders. The Surviving Articles shall continue to be operative notwithstanding such termination of Part B of the Articles of Association, subject to approval of the same by the shareholders of the Company, by way of a special resolution, post listing of the Equity Shares of the Company.

Pursuant to Schedule I of the Companies Act and the SEBI ICDR Regulations, the main provisions of the Articles of Association of our Company are detailed below:

PART A

Authorised Share Capital

The authorized share capital of the Company shall be such amount, divided into such class(es), denomination(s) and number of shares in the Company as stated in Clause V of the MoA or as altered from time to time, with power to increase or reduce such capital from time to time and power to divide the shares in the capital for the time being into other classes and to attach thereto such preferential, convertible, deferred, qualified, or other special rights, privileges, conditions or restrictions and to vary, modify or abrogate the same in such manner as may be determined by or in accordance with the Articles of the Company, subject to the provisions of applicable law for the time being in force.

Alteration of Capital

Power to sub-divide, consolidate and cancel share certificate.

The Company may, by Ordinary Resolution in its General Meetings, from time to time, alter the conditions of MoA as follows:

- a. Increase the share capital by such amount to be divided into shares of such amount as it thinks expedient;
- b. Consolidate and divide all or any its share capital into shares of larger amount than its existing shares; provided that any consolidation and division which results in changes in the voting percentage of Members shall require applicable approvals under the Act;
- c. Sub-divide its existing shares or any of them into shares of smaller amount than is fixed by MoA;
- d. Cancel any shares which, at the date of the passing of the resolution, have not been taken or agreed to be taken by any person; and
- e. Convert all or any one its fully paid-up shares into stock, and reconvert that stock into fully paid-up shares of any denomination.

Allotment of Shares

Subject to the provisions of the Act and the Articles, the shares in the capital of the Company for the time being shall be under the control of the Board who may issue, allot or otherwise dispose of the same or any of them to such persons, in such proportion and on such terms and conditions and either at a premium or at par or at a discount and at such time as they may from time to time think fit and with the sanction of the Company in the General Meeting to give to any person the option or right to call for any shares either at par or premium during such time and for such consideration as the Board think fit, and with the sanction of the Company in General Meeting give to any person the option or right to call for any shares either at par or at a premium during such time and for such consideration as the Board thinks fit.

Lien

The Company shall subject to applicable law have a first and paramount lien on every share / debenture (not being a fully paid share / debenture) registered in the name of each Member (whether solely or jointly with others) and upon the proceeds of sale thereof for all moneys (whether presently payable or not) called, or payable at a fixed time, in respect of that share / debenture and no equitable interest in any share shall be created upon the footing and condition that this article will have full effect. The Company may sell, in such manner as the Board thinks fit, any shares on which the Company has a lien: provide that no sale shall be made until the expiration of 14 days’ after a notice in writing stating and demanding payment of such part of the amount in respect of which the lien exists as is presently payable, has been given to the registered holder of the share.

Share Certificate

Every Member of the Company shall be entitled, without payment to one or more certificates in marketable lots, for all the shares of each class or denomination registered in his name, or if the Directors approve, to several certificates, each for one or more of such shares and the Company shall complete and have ready for delivery such certificates, unless prohibited by any provision of law or any order of court, tribunal or other authority having jurisdiction, within two (2) months from the date of allotment, or within one (1) month of the receipt of application of registration of transfer, transmission, sub division, consolidation or renewal of any of its shares as the case maybe or within a period of six (6) months from the date of allotment in the case of any allotment of debenture. The provisions of the Act shall be complied with in the issue, reissue, renewal of share certificates and the format, sealing and signing of the certificates and records of the certificates issued shall be maintained in accordance with the said Act.

Every certificate of shares shall be under the Seal of the Company and shall specify the shares to which it relates and the amount paid-up thereon.

If any certificate be defaced, mutilated, torn or old, decrepit, worn- out or if there be no further space on the back thereof for endorsement of transfer, then upon production and surrender thereof to the Company, a new certificate may be issued in lieu thereof, and if any certificate is lost or destroyed then upon proof thereof to the satisfaction of the Company and on execution of such indemnity as the Company deem adequate, being given, a new certificate in lieu thereof shall be given to the party entitled to such lost or destroyed certificate.

No fee shall be charged for sub-division and consolidation of share / debenture certificates and for sub-division of letters of allotment, split and consolidation.

Transfer of Shares

The instrument of transfer of any share shall be in writing and all the provisions of the Act shall be duly complied with in respect of all transfer of shares and registration thereof. The Company shall use the form of transfer, as prescribed under the Act, in all cases. In case of transfer of shares, where the Company has not issued any certificates and where the shares are held in dematerialized form, the provisions of the Depositories Act, 1996 shall apply. The Board may decline to recognize any instrument of transfer unless the instrument of transfer is in the form prescribed under the Act, is in respect of only one class of shares and is accompanied by the certificate of shares to which it relates, and such other evidence as the Board may reasonably require to show the right of the transferor to make the transfer.

Transmission of shares

The executors or administrators or the holders of a succession certificate issued in respect of the shares of a deceased Member and not being one of several joint holders shall be the only person whom the Company shall recognize as having any title to the shares registered in the name of such Members and in case of the death of one or more of the joint holders of any registered share, the survivor or survivors shall be entitled to the title or interest in such shares but nothing herein contained shall be taken to release the estate of a deceased joint holder from any liability on shares held by him jointly with any other person. Before recognizing any legal representative or heir or a person otherwise claiming title to the shares the Company may require him to obtain a grant of probate or letters of administration or succession certificate or other legal representation as the case may be from a competent court, provided nevertheless that in any case where the Board in its absolute discretion think fit, it shall be lawful for the Board to dispense with production of the probate or letter of administration or a secession certificate or such other legal representation upon such terms as to indemnity or otherwise as the Board may consider desirable.

Any person becoming entitled to shares in consequence of the death, lunacy, bankruptcy or insolvency of any Members, or by any lawful means other than by a transfer in accordance with the Articles, may with the consent of the Board (which it shall not be under any obligation to give), upon producing such evidence as the Board thinks sufficient, that he sustains the character in respect of which he proposes to act under this Article, or of his title, elect to either be registered himself as holder of the shares or elect to have some person nominated by him and approved by the Board, registered as such holder or to make such transfer of the share as the deceased or insolvent member could have made. If the person so becoming entitled shall elect to be registered as holder of the share himself, he shall deliver or send to the Company a notice in writing signed by him stating that he so elects. Provided, nevertheless, if such person shall elect to have his nominee registered, he shall testify that election by executing in favour of his nominee an instrument of transfer in accordance with the provision herein contained and until he does so he shall not be freed from any liability in respect of the shares.

Borrowing Powers

The Board may, from time to time and at its discretion, raise or borrow or secure the payment of any sums or sum of money for the purposes of the Company in such manner and upon such terms and conditions in all respects as it thinks fit.

Issue of Bonus Shares

The Company in its General Meeting may resolve to issue the bonus shares to its shareholders subject to the applicable provisions of the Act and other laws as may be applicable in this behalf from time to time.

General Meetings

All General Meetings of the Company other than the Annual General Meeting shall be called an Extra-ordinary General Meeting. The notice of a General Meeting shall be given to the Members of the Company, the persons entitled to a share in consequence of the death or insolvency of a Member, the Directors of the Company and the auditors for the time being of the Company.

Meetings of Directors

The Board of Directors shall meet at least once in every three months with a maximum gap of four months between two meetings of the Board for the dispatch of business, adjourn and otherwise regulate its meetings and proceedings as it thinks fit in accordance with the Act, provided that at least four such meetings shall be held in every year. Notice of at least seven days, in writing of every meeting of the Board shall be given to every Director and every alternate Director at his usual address whether in India or abroad. The notice shall include the time, venue and agenda of such meeting.

The quorum for a meeting of the Board shall be one third of its total strength (any fraction contained in that one-third being rounded off as one) or two Directors whichever is higher and the participation of the Directors by video conferencing or by other audio visual means shall also be counted for the purposes of quorum. If within half an hour from the time appointed for a meeting of the Board, a quorum is not present, the meeting, shall stand adjourned to the same day in the next week at the same time and place or to such other day and at such other time and place as the Directors may determine.

Managing Directors

Subject to the provision of the Act, the Board may, from time to time, appoint one or more Directors to be managing director or managing directors of the Company and may, from time to time. The managing director shall not be liable to retirement by rotation as long as he holds office as managing director.

Appointment of Directors

Unless otherwise determined by General Meeting, the number of Directors shall not be less than three (3) and not more than fifteen (15), and at least one (1) Director shall be resident of India in the previous year. Provided that the Company may appoint more than fifteen (15) directors after passing a Special Resolution.

Client Ebene Limited may nominate one director on the Board, provided that the Client Ebene Limited holds at least 5% of the issued and paid-up capital on a fully diluted basis, who does not hold any executive position in any Person engaged in the Business, provided that if any Person holding non-executive position in any Person engaged in the Business, is appointed as an Investor Director, then such Person so appointed shall be required to be bound by suitable non-disclosure undertakings with respect to Confidential Information pertaining to the Company and the Subsidiaries, that may be received in connection with the appointment of such Person as an Investor Director. It is hereby clarified that Investor 2 shall not have a right to appoint nominee directors on the Board; and

Promoters may nominate two directors on the Board, who shall be the representative of the Promoters on the Board, provided that the Promoters cumulatively hold at least 5% of the issued and paid-up capital on a fully diluted basis.

Votes of Members

On a show of hands every Member present in person and being a holder of Equity Shares shall have one vote and every person present either as a Proxy on behalf of a holder of Equity Shares or as a duly authorized representative of a body corporate being a holder of Equity Shares, if he is not entitled to vote in his own right, shall have one vote.

On a poll, the voting rights of holder of Equity Shares shall be in proportion to his share in the paid-up Equity Share capital of the Company. A Member may exercise his vote at a meeting by electronic means in accordance with the Act and shall vote only once.

A person becoming entitled to a share shall not before being registered as Member in respect of the share be entitled to exercise in respect thereof any right conferred by membership in relation to meeting of the Company.

No Member shall be entitled to exercise any voting rights either personally or by Proxy at any meeting of the Company in respect of any shares registered in his name on which any calls or other sums presently payable by him have not been paid or in regard to which the Company has exercised any right or lien.

Dividend

The Company in General Meeting may declare the dividends, but no dividend shall exceed the amount recommended by the Board. The Board may from time to time pay to the Members such interim dividends of such amount on such class of shares and at such times as it may think fit.

All dividends shall be apportioned and paid proportionately to the amounts paid or credited as paid on the shares during any portion or portions of the period in respect of which the dividend is paid; but if any share is issued on terms providing that it shall rank for dividend as from a particular date such share shall rank for dividend accordingly.

No dividend shall bear interest against the Company.

Unpaid or Unclaimed Dividend

Any dividend remaining unpaid or unclaimed after having been declared shall be dealt in accordance with the provisions of the applicable law.

Where the Company has declared a dividend but which has not been paid or claimed within 30 days from the date of declaration to any shareholder entitled to the payment of the dividend, the Company shall within seven days from the date of expiry of the said period of 30 days, open a special account in that behalf in any scheduled bank and transfer to such account, the total amount of the dividend which remains unpaid or in relation to which no dividend warrant has been posted.

Any money transferred to the said special account of the Company which remains unpaid or unclaimed for a period of seven years from the date of such transfer, shall be transferred by the Company to the fund known as “Investor Education and Protection Fund” established under the Act.

No unclaimed or unpaid dividend shall be forfeited by the Board before the claim becomes barred by law and the Company shall comply with the provisions of the applicable laws in respect of such dividend.

Winding Up

Subject to the provisions of applicable law, the assets of the Company shall, on its winding up, be applied in satisfaction of its liabilities *pari passu* and, subject to such application, such assets shall be distributed among the Members according to their rights and interests in the Company.

Indemnity

Subject to the provisions the Act, the Company shall indemnify every Director and Officer of the Company against any liability incurred by them in defending any proceedings, whether civil or criminal, in which judgment is given in their favour or in which they are acquitted or in which relief is granted to them by the court or the tribunal. However, such indemnification shall not apply in respect of any cost or loss or expenses to the extent it is finally judicially determined to have resulted from the negligence, willful misconduct or bad faith acts or omissions of such Director.

PART B

*The Articles of Association of the Company comprise of two parts, Part A and Part B, which parts shall, unless the context otherwise requires, co-exist with each other. In case of inconsistency between Part A and Part B, the provisions of Part B shall be applicable. However, other than the definitions of Inflow, Investor Benchmark Rate, IRR, Outflow and Tax under Article 2.1, and Article 18.3 of Part B (“**Surviving Articles**”), Part B of the Articles of Association shall automatically terminate and cease to have any force and effect from the date of listing of equity shares of the Company on a recognized stock exchange in India pursuant to an initial public offering of the Equity Shares of the Company, without any further action, including any corporate action, by the Company or by the shareholders. The Surviving Articles shall continue to be operative notwithstanding such termination of Part B of the Articles of Association, subject to approval of the same by the shareholders of the Company, by way of a special resolution, post listing of the Equity Shares of the Company.*

Article 18.1 of the Part B of the Articles of Association provides that in consideration of the investment opportunity provided by the Key Promoters to the Investors and execution of the Transaction Documents, and also in consideration of the fact that the Key Promoters are the promoters of the Company and are/will be managing the operations and performance of the Company, the Investors have agreed to grant the Key Promoters an upside sharing and the right to acquire further Shares in accordance with and subject to the terms and conditions of this Article 18.

Article 18.3 (i) of Part B of the Articles of Association provides that each of the Investors agrees that following the provision of full cash exit to such Investor in compliance with the Transaction Documents, in the event that such Investor’s Inflows are (following payouts of employee incentives pursuant to the Shareholders Agreement) in excess of the Investor Benchmark Rate, such Investor agrees to share 30% of such excess of Inflows over the Investor Benchmark Rate with the Key Promoters

(“Promoter Upside Entitlement”). The requirement to share the Promoter Upside Entitlement may be provided by such Investor at its sole discretion, either (a) by way of a cash payment, subject to withholding of applicable taxes; or (b) by any other method determined by the Investor that achieves the same commercial effect.

Article 18.3(ii) of Part B of the Articles of Association provide that the method by which the payment of the Promoter Upside Entitlement shall be determined at the sole discretion of the Investors without diluting in any manner the Investors' rights set out in the Articles.

SECTION IX: OTHER INFORMATION

MATERIAL CONTRACTS AND DOCUMENTS FOR INSPECTION

The copies of the following documents and contracts which have been entered or are to be entered into by our Company (not being contracts entered into in the ordinary course of business carried on by our Company or contracts entered into more than two years before the date of this Red Herring Prospectus) which are or may be deemed material have been attached to the copy of this Red Herring Prospectus and will be attached to the Prospectus, as applicable, which will be delivered to the RoC for filing. Copies of the abovementioned documents and contracts and also the documents for inspection referred to hereunder, may be inspected at the Registered Office between 10 a.m. and 5 p.m. on all Working Days from date of this Red Herring Prospectus until the Bid/ Offer Closing Date.

A. Material Contracts for the Offer

1. Offer Agreement dated June 9, 2021 between our Company, the Selling Shareholders and the BRLMs.
2. Registrar Agreement dated June 2, 2021 between our Company, the Selling Shareholders and the Registrar to the Offer.
3. Cash Escrow and Sponsor Bank Agreement dated September 6, 2021 between our Company, the Selling Shareholders, the Registrar to the Offer, the BRLMs, the Escrow Collection Bank(s), Sponsor Bank, Public Offer Bank and the Refund Bank(s).
4. Share Escrow Agreement dated September 6, 2021 between our Company, the Selling Shareholders and the Share Escrow Agent.
5. Syndicate Agreement dated September 6, 2021 between our Company, the Selling Shareholders, the BRLMs and the Registrar to the Offer.
6. Underwriting Agreement dated [●] between our Company, the Selling Shareholders and the Underwriters.

B. Material Documents

1. Certified copies of the updated MoA and AoA of our Company as amended from time to time.
2. Certificate of incorporation dated December 15, 1981.
3. Fresh certificate of incorporation dated June 29, 2018 issued by RoC at the time of conversion from a private limited company into a public limited company.
4. Resolution of the Board dated March 18, 2021, authorising the Offer.
5. Resolution of the Shareholders dated June 2, 2021, authorising the Offer.
6. Board resolution dated June 9, 2021 approving the Draft Red Herring Prospectus.
7. Board resolution dated September 6, 2021 approving this Red Herring Prospectus;
8. Resolutions of the board of directors of Client Ebene Limited and CVCIGP II Employee Ebene Limited each dated May 25, 2021 and consent letters each dated May 27, 2021 authorising their participation in the Offer.
9. Consent letters of Subramonia Sekhar Vasan, Unni Rajagopal Kothenath, Fatheraj Singhvi and Devappa Devaraj , each dated May 31, 2021 for participating in the Offer.
10. Copies of the annual reports of our Company for the Financial Years 2021, 2020 and 2019.
11. The examination report of the Statutory Auditors, on our Restated Consolidated Financial Information, included in this Red Herring Prospectus along with the Restated Consolidated Financial Information.
12. The statement of special tax benefits dated September 6, 2021 from the Statutory Auditors.
13. Written consent of the Directors, the BRLMs, Domestic Legal Counsel to our Company, Domestic Legal Counsel to the BRLMs as to Indian Law, International Legal Counsel to the BRLMs, Registrar to the Offer, Escrow Collection Bank(s), Public Offer Bank(s), Refund Bank(s), Sponsor Bank, Bankers to our Company, Company Secretary and Compliance Officer as referred to in their specific capacities.

14. Written consent of the Statutory Auditors dated September 6, 2021 to include their name as required under Section 26(5) of the Companies Act in this Red Herring Prospectus and as an “expert” as defined under Section 2(38) of the Companies Act.
15. Report titled ‘*Assessment of Indian Automotive and Precision Engineering Industry and Potential for Specific Forged and Machined Components*’ issued on June 5, 2021 by CRISIL Research. Engagement letter dated February 9, 2021 for appointment of CRISIL Research.
16. Consent letter dated June 5, 2021 of CRISIL in respect of the CRISIL Report.
17. Report titled ‘*Global Industry Overview and Market Sizing of Specific Powertrain Components*’ dated June 4, 2021, issued by Ricardo. Engagement letter dated April 13, 2021 for appointment of Ricardo.
18. Consent letter dated June 4, 2021 of Ricardo in respect of the Ricardo Report.
19. Scheme of amalgamation of Gearrock Forge Private Limited with our Company as approved by the Ministry of Corporate Affairs, Regional Director, South East Region, Hyderabad.
20. Shareholders’ agreement dated May 29, 2013 entered into amongst our Company, CVCIGP II Employee Ebene Limited, Client Ebene Limited, Subramonia Sekhar Vasam, Fatheraj Singhvi, Unni Rajagopal Kothenath, Devappa Devaraj , Karthik Das and Anjana Iyer, as amended on March 23, 2016
21. Amendment agreement dated August 8, 2018 entered into amongst our Company, Subramonia Sekhar Vasam, Fatheraj Singhvi, Unni Rajagopal Kothenath, Devappa Devaraj, Client Ebene Limited, CVCIGP II Employee Ebene Limited and other shareholders, as amended by the first amendment agreement dated March 29, 2019, the second amendment agreement dated November 5, 2019, the third amendment agreement dated January 1, 2020, the fourth amendment agreement dated June 15, 2020, the fifth amendment agreement dated October 21, 2020, the sixth amendment agreement dated January 27, 2021 and the seventh amendment dated April 27, 2021
22. Share Subscription Agreement dated May 29, 2013 entered into amongst our Company, EEL, Client Ebene Limited, Subramonia Sekhar Vasam, Fatheraj Singhvi, Unni Rajagopal Kothenath, Devappa Devaraj , Karthik Das and Anjana Iyer, as amended on March 23, 2016
23. Share Purchase Agreement dated May 29, 2013 entered into amongst our Company, Subramonia Sekhar Vasam, Fatheraj Singhvi, Unni Rajagopal Kothenath, Devappa Devaraj, certain members of the promoter group, CVCIGP II Employee Ebene Limited and Client Ebene Limited
24. Share Purchase Agreement dated August 1, 2014 entered into between our Company, Fitwel Tools and Forgings Private Limited, Subramanya Doddaballapur Ramarao, D Narayan, D L Shakunthala, Kavitha Rama Shekar, certain key individual shareholders and other shareholders of Fitwel Tools and Forgings Private Limited
25. Share Purchase Agreement dated April 14, 2017 entered into between MAPE Technology S.r.l. and Sansera Engineering Pvt. Ltd., Mauritius
26. Consent letter dated June 3, 2021 from M.S. Balu, as chartered engineer to include their name as an “expert” as defined under Section 2(38) and other applicable provisions of the Companies Act, 2013 in its capacity as a ‘chartered engineer’, in respect of the certificates dated June 3, 2021 and August 18, 2021, 2021 received from them.
27. Due diligence certificate dated June 9, 2021, addressed to SEBI from the BRLMs.
28. In principle listing approval dated June 28, 2021 and July 8, 2021 issued by BSE and NSE, respectively.
29. Tripartite agreement dated September 11, 2018 between our Company, NSDL and the Registrar to the Offer.
30. Tripartite agreement dated September 10, 2018 between our Company, CDSL and the Registrar to the Offer.
31. SEBI observation email dated July 2, 2021 and July 14, 2021 and SEBI final observation letter bearing reference number SEBI/HO/CFD/DIL2/YJ/NS/18379/1/2021 and dated August 6, 2021.

Any of the contracts or documents mentioned in this Red Herring Prospectus may be amended or modified at any time if so required in the interest of our Company or if required by the other parties, without notice to the shareholders subject to compliance of the provisions contained in the Companies Act and other relevant statutes.

DECLARATION

We hereby certify and declare that all relevant provisions of the Companies Act and the guidelines issued by the Government of India or the regulations, rules or guidelines issued by SEBI, established under Section 3 of the SEBI Act, as the case may be, have been complied with and no statement made in this Red Herring Prospectus is contrary to the provisions of the Companies Act, the SCRA, the SEBI Act or rules or regulations made or guidelines issued thereunder, as the case may be. We further certify that all disclosures made in this Red Herring Prospectus are true and correct.

SIGNED BY THE DIRECTOR OF OUR COMPANY



S Sekhar Vasan
(Chairman and Managing Director)

Place: Bangalore
Date: 06-09-2021

DECLARATION

We hereby certify and declare that all relevant provisions of the Companies Act and the guidelines issued by the Government of India or the regulations, rules or guidelines issued by SEBI, established under Section 3 of the SEBI Act, as the case may be, have been complied with and no statement made in this Red Herring Prospectus is contrary to the provisions of the Companies Act, the SCRA, the SEBI Act or rules or regulations made or guidelines issued thereunder, as the case may be. We further certify that all disclosures made in this Red Herring Prospectus are true and correct.

SIGNED BY THE DIRECTOR OF OUR COMPANY

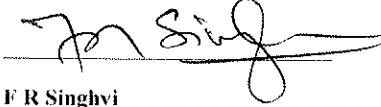
A handwritten signature in black ink, appearing to read 'F R Singhvi', is written over a horizontal line.

F R Singhvi
(Joint Managing Director)

Place: Bangalore

Date: 06-09-2021

DECLARATION

We hereby certify and declare that all relevant provisions of the Companies Act and the guidelines issued by the Government of India or the regulations, rules or guidelines issued by SEBI, established under Section 3 of the SEBI Act, as the case may be, have been complied with and no statement made in this Red Herring Prospectus is contrary to the provisions of the Companies Act, the SCRA, the SEBI Act or rules or regulations made or guidelines issued thereunder, as the case may be. We further certify that all disclosures made in this Red Herring Prospectus are true and correct.

SIGNED BY THE DIRECTOR OF OUR COMPANY

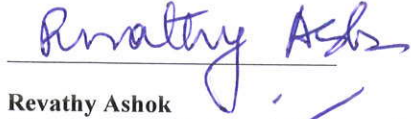

Revathy Ashok
(*Non-Executive, Independent Director*)

Place: Bangalore
Date: 06-09-2021

DECLARATION

We hereby certify and declare that all relevant provisions of the Companies Act and the guidelines issued by the Government of India or the regulations, rules or guidelines issued by SEBI, established under Section 3 of the SEBI Act, as the case may be, have been complied with and no statement made in this Red Herring Prospectus is contrary to the provisions of the Companies Act, the SCRA, the SEBI Act or rules or regulations made or guidelines issued thereunder, as the case may be. We further certify that all disclosures made in this Red Herring Prospectus are true and correct.

SIGNED BY THE DIRECTOR OF OUR COMPANY

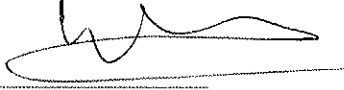

Sylvain Bilaine
(Non-Executive, Independent Director)

Place: Luxembourg

Date: 06-09-2021

DECLARATION

We hereby certify and declare that all relevant provisions of the Companies Act and the guidelines issued by the Government of India or the regulations, rules or guidelines issued by SEBI, established under Section 3 of the SEBI Act, as the case may be, have been complied with and no statement made in this Red Herring Prospectus is contrary to the provisions of the Companies Act, the SCRA, the SEBI Act or rules or regulations made or guidelines issued thereunder, as the case may be. We further certify that all disclosures made in this Red Herring Prospectus are true and correct.

SIGNED BY THE DIRECTOR OF OUR COMPANY



Muthuswami Lakshminarayan
(Non-Executive, Independent Director)

Place: Bangalore
Date: 06.09.2021

DECLARATION

We hereby certify and declare that all relevant provisions of the Companies Act and the guidelines issued by the Government of India or the regulations, rules or guidelines issued by SEBI, established under Section 3 of the SEBI Act, as the case may be, have been complied with and no statement made in this Red Herring Prospectus is contrary to the provisions of the Companies Act, the SCRA, the SEBI Act or rules or regulations made or guidelines issued thereunder, as the case may be. We further certify that all disclosures made in this Red Herring Prospectus are true and correct.

SIGNED BY THE DIRECTOR OF OUR COMPANY



Raunak Gupta

(Non-Executive, Nominee Director)

Place: Mumbai

Date: 06-09-2021

DECLARATION

We hereby certify and declare that all relevant provisions of the Companies Act and the guidelines issued by the Government of India or the regulations, rules or guidelines issued by SEBI, established under Section 3 of the SEBI Act, as the case may be, have been complied with and no statement made in this Red Herring Prospectus is contrary to the provisions of the Companies Act, the SCRA, the SEBI Act or rules or regulations made or guidelines issued thereunder, as the case may be. We further certify that all disclosures made in this Red Herring Prospectus are true and correct.

SIGNED BY CHIEF FINANCIAL OFFICER

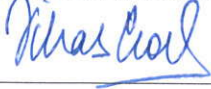

Vikas Goel
(Chief Financial Officer)

Place: Bangalore
Date: 06.09.2021

DECLARATION

The undersigned Selling Shareholder hereby certifies that all statements and undertakings made by it in this Red Herring Prospectus, solely and specifically in relation to itself and its respective portion of the Equity Shares being sold in the Offer for Sale, are true and correct. The undersigned Selling Shareholder assumes no responsibility for any of the statements made by the Company or any expert or any other person(s) in this Red Herring Prospectus.

Signed by the Selling Shareholder



For Client Ebene Limited

Place: Ebene, Mauritius

Date: 06-09-2021

DECLARATION

The undersigned Selling Shareholder hereby certifies that all statements and undertakings made by it in this Red Herring Prospectus, solely and specifically in relation to itself and its respective portion of the Equity Shares being sold in the Offer for Sale, are true and correct. The undersigned Selling Shareholder assumes no responsibility for any of the statements made by the Company or any expert or any other person(s) in this Red Herring Prospectus.

Signed by the Selling Shareholder



For CVCIGP II Employee Ebene Limited

Place: Ebene, Mauritius

Date: 06-09-2021

DECLARATION

The undersigned Selling Shareholder hereby certifies that all statements and undertakings made by it in this Red Herring Prospectus, solely and specifically in relation to itself and its respective portion of the Equity Shares being sold in the Offer for Sale, are true and correct. The undersigned Selling Shareholder assumes no responsibility for any of the statements made by the Company or any expert or any other person(s) in this Red Herring Prospectus.

Signed by the Selling Shareholder



S Sekhar Vasan

Place: Bangalore

Date: 06-09-2021

DECLARATION

The undersigned Selling Shareholder hereby certifies that all statements and undertakings made by it in this Red Herring Prospectus, solely and specifically in relation to itself and its respective portion of the Equity Shares being sold in the Offer for Sale, are true and correct. The undersigned Selling Shareholder assumes no responsibility for any of the statements made by the Company or any expert or any other person(s) in this Red Herring Prospectus.

Signed by the Selling Shareholder

A handwritten signature in black ink, appearing to read 'F R Singhvi', is written over a horizontal line.

F R Singhvi

Place: Bangalore

Date: 06-09-2021

DECLARATION

The undersigned Selling Shareholder hereby certifies that all statements and undertakings made by it in this Red Herring Prospectus, solely and specifically in relation to itself and its respective portion of the Equity Shares being sold the Offer for Sale, are true and correct. The undersigned Selling Shareholder assumes no responsibility for any of the statements made by the Company or any expert or any other person(s) in this Red Herring Prospectus.

Signed by the Selling Shareholder

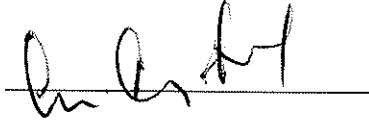
A handwritten signature in black ink, appearing to read 'Unni Rajagopal K', is written over a horizontal line.

Unni Rajagopal K

Place: Bangalore

Date: 06-09-2021

DECLARATION

The undersigned Selling Shareholder hereby certifies that all statements and undertakings made by it in this Red Herring Prospectus, solely and specifically in relation to itself and its respective portion of the Equity Shares being sold in the Offer for Sale, are true and correct. The undersigned Selling Shareholder assumes no responsibility for any of the statements made by the Company or any expert or any other person(s) in this Red Herring Prospectus.

Signed by the Selling Shareholder



D Devaraj

Place: Bangalore

Date: 06-09-2021

DECLARATION

The undersigned Selling Shareholder hereby certifies that all statements and undertakings made by it in this Red Herring Prospectus, solely and specifically in relation to itself and its respective portion of the Equity Shares being sold in the Offer for Sale, are true and correct. The undersigned Selling Shareholder assumes no responsibility for any of the statements made by the Company or any expert or any other person(s) in this Red Herring Prospectus.

Signed by the Selling Shareholder

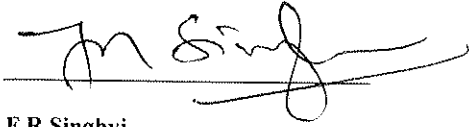
A handwritten signature in black ink, appearing to read 'F R Singhvi', is written over a horizontal line. The signature is stylized and cursive.

F R Singhvi

**For and on behalf of Lalitha Singhvi, Praveen Singhvi,
Lata Singhvi, Jayaraj Singhvi, Tara Singhvi and
Indira Singhvi**

Place: Bangalore

Date: 06-09-2021